

# Nienhuis

---

MONTESSORI



[www.nienhuis.com](http://www.nienhuis.com)

The global standard

# Content

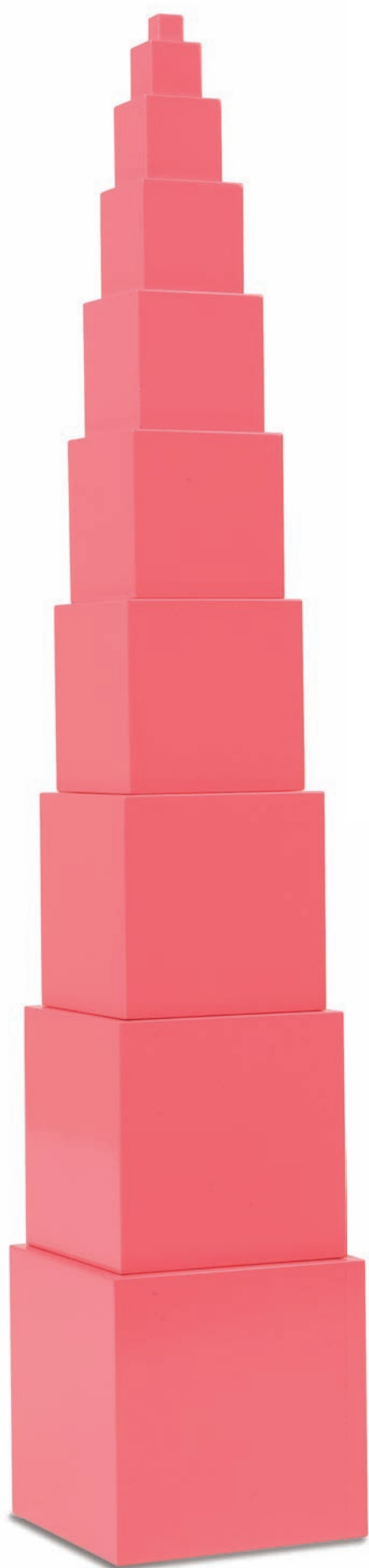

Infant Toddler	12
Practical Life	32
Sensorial	48
Language	80
Mathematics	118
Biology	202
Geography	214
Accessories	246
Furniture	270
Books	302
Arts And Crafts	330
Music	354
Enrichment	362
Bikes And Trikes	464
Spareparts	472
Index	542

# Timeline

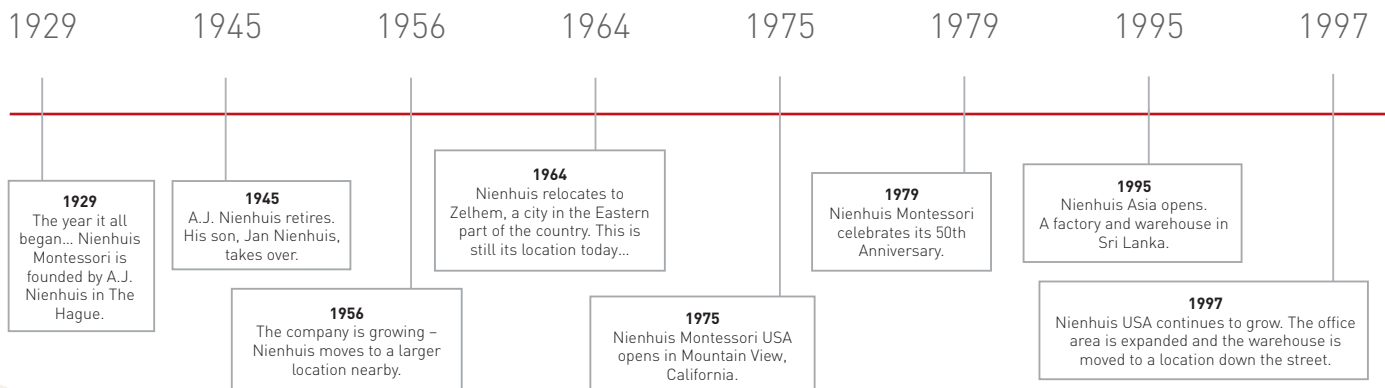

## The Montessori Method

Dr. Maria Montessori began her career as an educator of children working with a group of 50 children, three to five year olds, on January 6th, 1907 in the city of Rome.

She had at her disposal an untrained assistant, a room, a bit of furniture and developmental materials to aid sense perception that she had previously used when working with mentally handicapped children. The children who were older, had to be encouraged before their interest was aroused. Once enticed to use the materials, their attention was volatile. Dr. Montessori was astonished to see that the little ones however, were intensely attracted by the materials, working spontaneously and repeatedly with them in total concentration.

Being a scientist, Dr. Montessori observed and responded to this phenomenon of spontaneous work generated by the apparatus. Through the experimental process of trial and error she created a highly specialized form of apparatus, which to the child, afforded a source of profound satisfaction. In addition, she provided an environment suited to and respectful of, the children's inherent characteristics: "the prepared environment". Out of this experimental foundation, the Montessori Method of Education evolved.

The present range of Montessori materials has in effect been selected by the children of the world in response to their inner directives. Invariably, children of all races, socio cultural and economic backgrounds have found an irresistible appeal in these materials and continue to do so for over a century.

Dr. Montessori and her son Mario, went on to design the entire range of Montessori education apparatus. In the 1920's they had the good fortune to meet Albert Nienhuis who accomplished to perfection the construction of the apparatus as specified by Maria and Mario Montessori. Together they established a close and lasting alliance.

To this day, the Montessori materials constructed by Nienhuis perpetuate in concrete form the demand for excellence, which is the cornerstone of Montessori education.



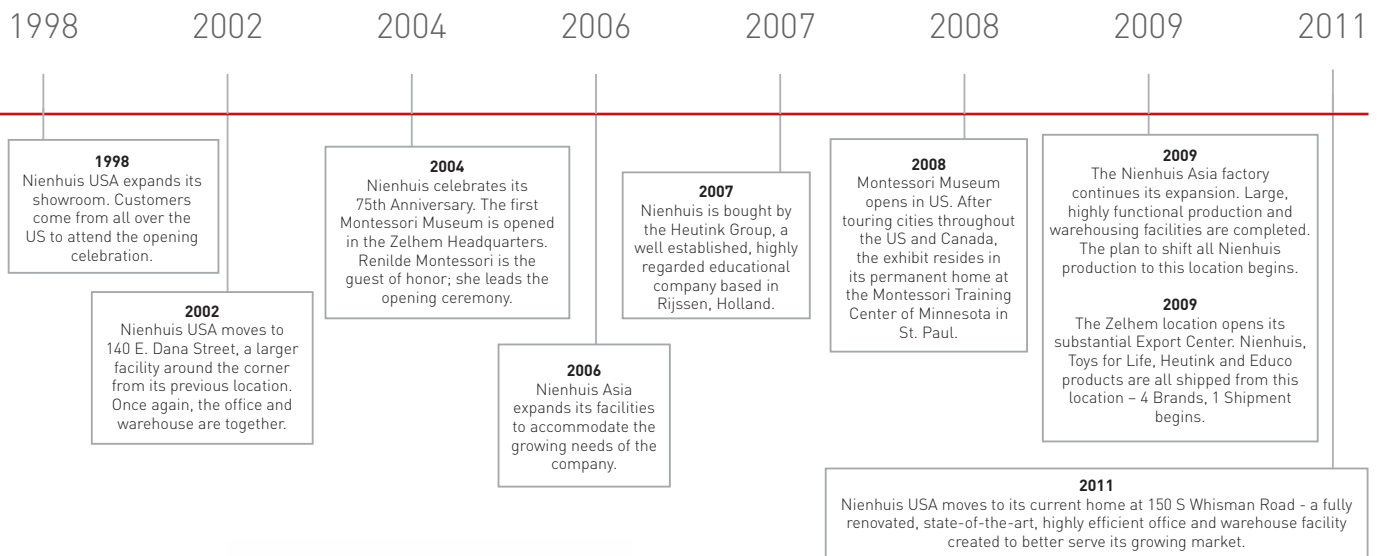

## Montessori Museum in Minnesota

In celebration of the 100-year anniversary of Montessori, the extensive exhibition - A Montessori Journey - was introduced to the world.

A Montessori Journey is a multisensory collection of materials, photos and rare period artifacts depicting the history and legacy of The Montessori Method and Maria Montessori. It is the largest Montessori museum of its kind.

The exhibit is a result of an international collaboration involving Germany, The United States, Australia and other countries in cooperation with the Centenary Committee of the Association Montessori Internationale and the North American Montessori Teachers' Association (NAMTA).

Previous to residing in its permanent home at the Montessori Training Center of Minnesota USA, the exhibit toured cities throughout North America - San Francisco, New York, Houston, Toronto, Washington DC and Cleveland.

**For further information go to: [www.mtcm.org](http://www.mtcm.org).**



# Welcome To Our World

Nienhuis

**Nienhuis**  
MONTESSORI

During the 1920's, our company founder, Albert Nienhuis collaborated with Dr. Maria Montessori for the purpose of constructing materials in accordance with her educational philosophy. These meetings led to a lasting association in which the evolution of her method became materialized in the workshop.

As the years went by, Dr. Montessori's educational method received worldwide acceptance. Nienhuis Montessori responded to this growth by expanding its compliment of artisans and the manufacturing facilities to meet the growing needs of the Montessori movement worldwide.

Today, after many decades, we continue our tradition of craftsmanship and quality with an understanding that results from our long association with Dr. Maria Montessori, Mario Montessori and the many Montessori leaders worldwide. As a result of this alliance, we are still developing new techniques, improving quality and implementing the newest technology in order to meet our responsibility as the largest authorized manufacturer and provider of authentic AMI approved Montessori materials.

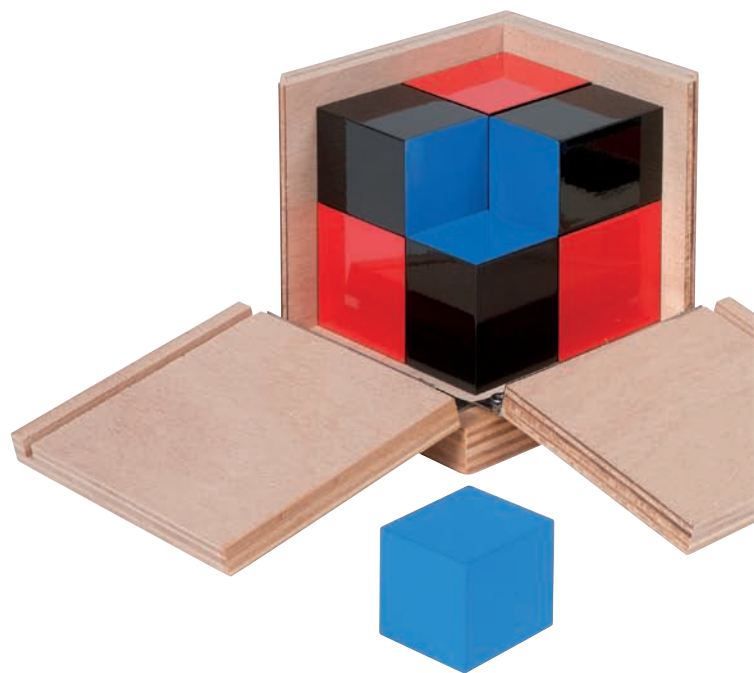

Educo

**educo**

Educo products have earned international distinction for durability, quality craftsmanship, educational value and innovative design. All Educo products are fully developed, under a strict quality control regime, and adhere to the highest possible standards. The Educo concept represents products with a high educational value, made of the finest materials, all with an attractive sales price.



# Toys for Life

The Toys for Life products are crafted of the finest materials, produced with the same care and responsibility as our Montessori materials, and have been developed in conjunction and consultation with educators and didactic specialists worldwide. Toys for Life products stand for top quality and are designed with an emphasis on educational value. Their cleverly designed products, with perfect finishing touches create an ideal extension to the classroom.

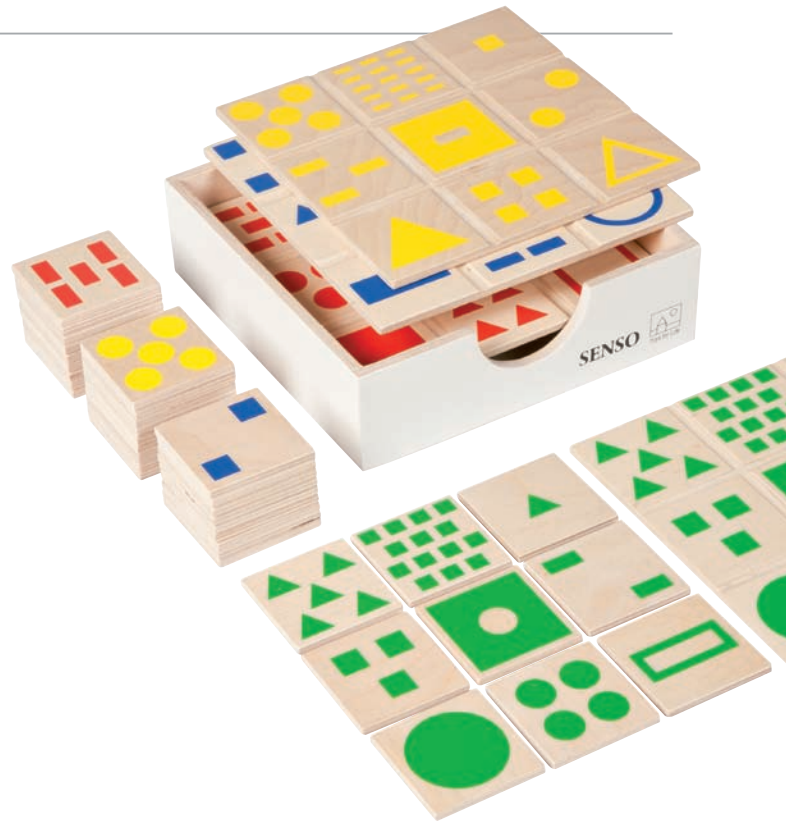

## Quality and Environmental Care

In the last few years all three of our Nienhuis locations – Holland, USA and Asia, have been certified for both the ISO 9001 Quality Standard, and the ISO 14001 Environment Standard.

Once acquiring these certificates, we felt great reward. We found that the standards necessary to obtain ISO certification directly paralleled the practices we have had in place throughout our company for many years - that of hard work and dedication to our customers and the environment. Our long-term efforts were validated.

In addition, we are FSC certified – a quality mark for responsible forest management worldwide. FSC certified forest products are verified from the forest of origin through the supply chain. The FSC label ensures that the forest products used are from responsibly harvested and verified sources.

The FSC certification provides a mechanism for companies, organizations, and communities to demonstrate their commitment to the FSC Principles and Criteria for responsible forest management and be part of the FSC solution.

It does not end with this... we will continue to develop our organization and make improvements in every way possible.



# The Production Process

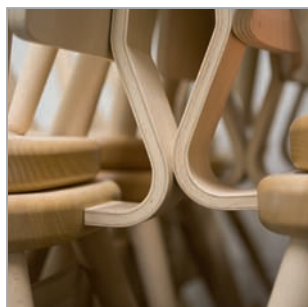

In a tradition that spans over eighty years, we continue to create the finest apparatus available with an integrity and devotion that brings us the pedagogical approval of the Montessori organizations around the world.

Great care is taken in the production process to ensure that every item has lasting quality. Skilled craftsmen with the latest tools of technology, yield precision products with magnificent detail. We use beechwood that is carefully selected and milled in our own extensive production facility in Sri Lanka. The timber is kiln-dried to prevent warping, cracking or shrinking. Precision cutting is controlled by the latest computer technology. Sturdy interlocking joinery and space age adhesives have almost eliminated the need for nails, screws or other metal fasteners. Our own exclusive methods of silk-screen and color printing directly onto finished wood have been developed through years of experience. The highest quality lacquer finishes are used to enhance the natural beauty of the wood.

Our products are manufactured with the safety of children in mind, not only in the raw materials, but also in the paints and finishes we use. Craftsmen who inspect every item on the production line monitor each step of the manufacturing process for quality. Finally, special attention is given to packing and transportation to insure safe arrival. We at Nienhuis Montessori, are proud to provide our customers with Montessori products that are second to none.

Nowadays, many newcomers claim to be authentic material manufacturers... these newcomers do not have the years of experience, knowledge or thoroughness that we do, nor are they privy to the 'official' AMI blueprints that specifically lay out the demands of each piece of material and as such, ensure the materials are produced according to the basic Montessori principles. It is easy to say you are authentic, but much more difficult to demonstrate it.

For over 80 years we have consistently focused our vision on producing only the highest quality Montessori materials. We believe that it is our inherent responsibility to nurture the development of all children while respecting and protecting the environment for future generations.

Minimum waste, maximum quality...

That is the Nienhuis tradition!

We are the Global Standard.

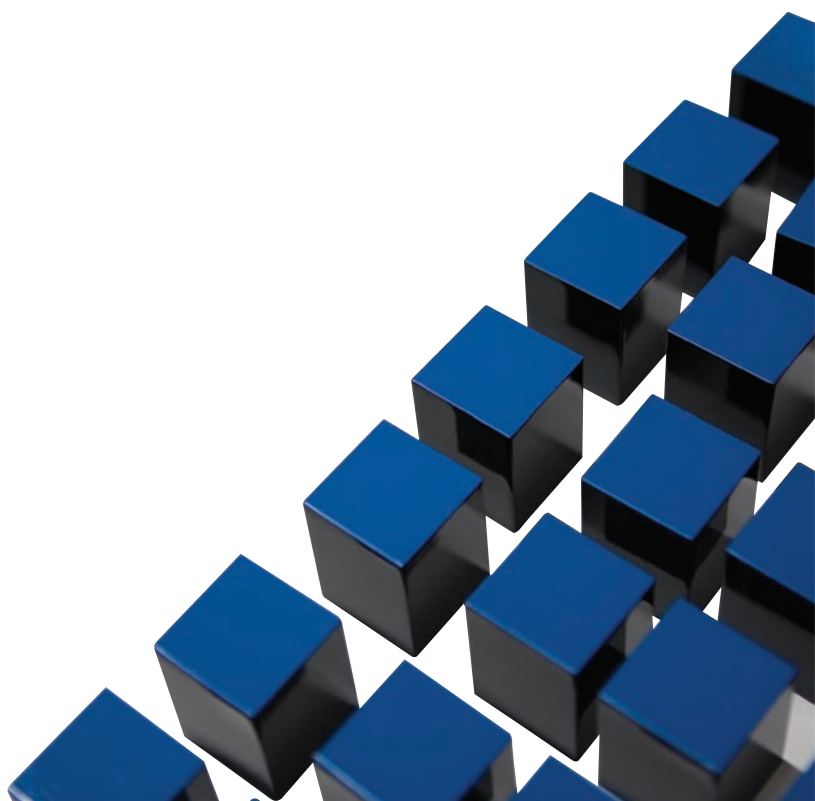

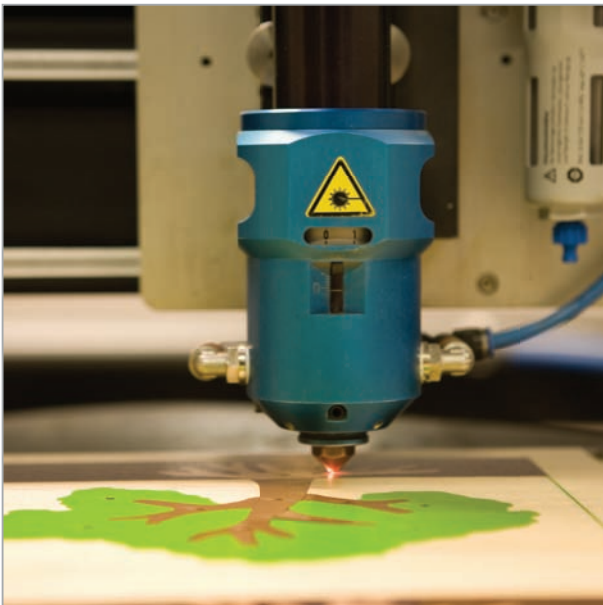
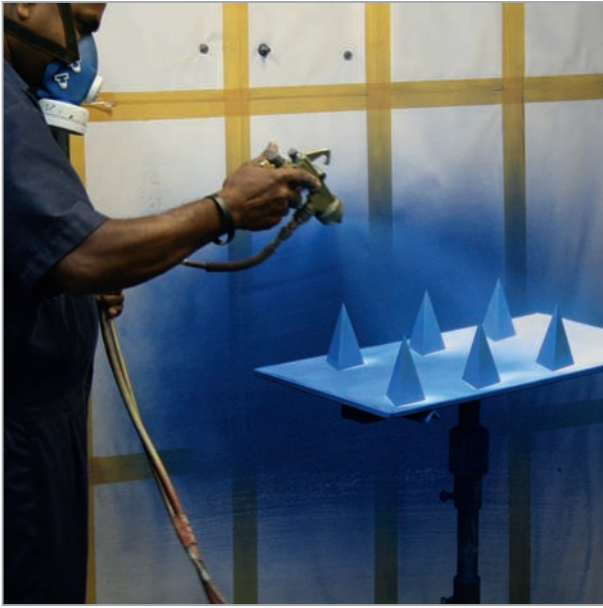



# Our Locations



## Nienhuis Holland

Nienhuis Holland is the head office of Nienhuis Montessori located in Zelhem, Holland. The Zelhem office markets its products worldwide through an extensive and ever increasing network of local distributors and representatives. For countries not served by a distributor the products are delivered directly.

The product development department of Nienhuis Montessori is based in Zelhem. We are always focused on new ideas, development and production of didactical apparatus. Our work with the major Montessori leaders worldwide ensures the products we produce are pedagogically correct. We encourage you to write or call if you have new ideas about Montessori educational materials.

The Nienhuis Montessori museum is located in the Zelhem facility. It was opened in 2004 during the celebration of our 75th Anniversary. Renilde Montessori was the guest of honor; she led the opening ceremony. There are several displays of materials through the decades, as well as a timeline, photos and films including an interesting and informative representation of Dr. Maria Montessori's ideas on education. It is a wonderful display of Montessori – past to future. We invite you to drop by for a visit.

For online ordering visit: [www.nienhuis.com](http://www.nienhuis.com).



**Nienhuis Montessori**  
Industriepark 14  
7021 BL Zelhem  
The Netherlands

**T** +31(0)314 – 62 71 10  
**F** +31(0)314 – 62 71 28  
**E** [info@nienhuis.nl](mailto:info@nienhuis.nl)

## Nienhuis USA

Nienhuis Montessori USA is the American branch of Nienhuis Montessori. The branch was established in 1975 to supply and service customers in the United States. Since this time we have taken over sales and distribution to Canada, Mexico, Central and South America as well as the Caribbean and other US Territories. Through close affiliation with our customers and the various Montessori organizations, we have improved our products and services, as well as helped to encourage the development of Montessori education in America.

We recently re-located to a completely renovated, larger, more efficient facility. Here we are better able to serve our many customers as well as stock more items in our substantial, state-of-the-art warehouse. In addition to our extensive line of Montessori apparatus, we also provide Enrichment and Toys for Life materials, as well as carry an extensive collection of Books, Publications, and DVD's for parents, teachers and classroom use.

With the purchase of Nienhuis by The Heutink Group in 2007, we have become a part of a larger whole. Through this venture, we have further expanded our assortment – we now offer materials produced and distributed by other members of The Group: Arts, Crafts and School Supplies from Heutink; Puzzles, Games and Various Manipulatives from Educo; and Furniture from Kids-F. All these products are world-renowned, of the highest quality, and perfectly fit with the high standard that Nienhuis has embraced since its existence.

Please stop by our showroom in Mountain View, California during business hours: Monday-Friday, from 8:00-4:30 PST. If you would like to combine your visit with a large material purchase, please call ahead so we may expedite your order.

**For online ordering visit: [www.nienhuis.com](http://www.nienhuis.com).**



**Nienhuis Montessori USA**  
**150 S. Whisman Road**  
**Mountain View, CA**  
**94041-1512**

**T** 1-650-964-2735  
1-800-942-8697  
**F** 1-650-964-8162  
**E** [info@nienhuis-usa.com](mailto:info@nienhuis-usa.com)

## Nienhuis Asia



Nienhuis Asia is the main production facility of Nienhuis Montessori. In an effort to continue being competitive in the Montessori market, keep our costs low, but yet continue to produce the finest Montessori materials, we opened our own production facility in Sri Lanka in 1995.

Through the years, our production team from Holland has diligently trained the local people about the specific Nienhuis production methods – in fact, several members of our team permanently moved to this location.

When we first started, we had two buildings – one a factory, the other a warehouse. Since the purchase of Nienhuis by The Heutink Group in 2007, this facility has grown substantially. Several additional buildings have been constructed, the warehouse has been expanded to three times its original size, and the production facility is state-of-the-art.

Today, we have an expert team of skilled craftsman and employees in our factory that have taken on the 'Nienhuis' tradition – that of producing products that are second to none.

**Nienhuis Montessori Asia**  
**Galpotta Estate, Kiriberiya**  
**Panadura**  
**Sri Lanka**



# Our Team

Dear Customer,

---

I am proud to present our new, expanded catalog. We offer our well-known full line of Montessori materials and have further extended this line with Arts And Crafts, Bikes And Trikes, Puzzles, Furniture, Music and for the first time, all of the available Spareparts. Everything you need for your school can be found in these pages.

Our materials, produced in our own factory in Sri Lanka, are available worldwide from our two Sales offices located in Zelhem, Holland and Mountain View, California. Our team of over 150 Nienhuis employees work and improve every day to bring you the highest quality products and service.

For your convenience, all of our materials are offered on our website. For personal guidance and/or ordering assistance, please contact one of our sales offices.

To order from the US, Canada, Mexico, Central and South America, please contact our US sales team in Mountain View.

For Europe and the rest of the world, we have a large network of distributors eager to assist you. Contact the sales team in Holland for further information.

We are always here to serve you and look forward to a long-term association!



Mitchell Eeftink  
CEO

## Sales Team Holland

---



Chris Willemsen  
Export Manager

T +31 (0)314 627111

E [c.willemsen@nienhuis.nl](mailto:c.willemsen@nienhuis.nl)

---



Michiel Hereijgers  
Distributor Sales

T +31 (0)314 627110

E [m.hereijgers@nienhuis.nl](mailto:m.hereijgers@nienhuis.nl)

---



Laury Visser  
Customer Service

T +31 (0)314 627110

E [l.visser@nienhuis.nl](mailto:l.visser@nienhuis.nl)

---



Marianne Breuer  
Sales (Germany)

T +31 (0)314 627110

E [m.breuer@nienhuis.nl](mailto:m.breuer@nienhuis.nl)

---



Mariëlle Oosterink  
Customer Service (Germany)

T +31 (0)314 627110

E [m.oosterink@nienhuis.nl](mailto:m.oosterink@nienhuis.nl)

---



## Sales Team USA



Karen S Kenison  
**Branch Manager**  
T 1-650-964-2735 x118  
E [k.kenison@nienhuis-usa.com](mailto:k.kenison@nienhuis-usa.com)



Dan Muilenburg  
**Sales Manager**  
T 1-650-964-2735 x114  
E [d.muilenburg@nienhuis-usa.com](mailto:d.muilenburg@nienhuis-usa.com)



Sarah Kenison  
**Office Manager • Sales**  
T 1-650-964-2735 x113  
E [s.kenison@nienhuis-usa.com](mailto:s.kenison@nienhuis-usa.com)



Nicki Sanford  
**Accounts Receivable**  
T 1-650-964-2735 x112  
E [n.sanford@nienhuis-usa.com](mailto:n.sanford@nienhuis-usa.com)



Irene Yano  
**Customer Service**  
T 1-650-964-2735 x116  
E [i.yano@nienhuis-usa.com](mailto:i.yano@nienhuis-usa.com)

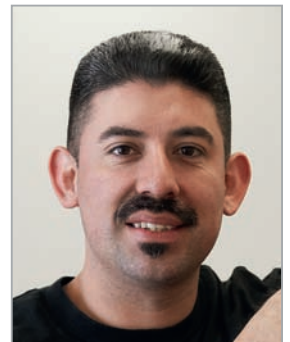

Armando Arriaga  
**Warehouse Manager**  
T 1-650-964-2735  
E [a.arriaga@nienhuis-usa.com](mailto:a.arriaga@nienhuis-usa.com)





# Infant Toddler

Continuing efforts at Nienhuis Montessori have produced an important extension to our spectrum of materials. Extensive research and consulting with experts in the infant toddler field has resulted in a unique line of Infant Toddler Montessori materials. We continually are expanding this line with new, innovative, specialized products that perfectly suit the infant toddler community.

Each new human being, from conception to maturity, forms himself or herself, taking from the environment (the womb, the home, the community) the materials for self-construction. In the first two months of life, the infant, having moved from the comfort of the womb, learns to trust the new outside world. During the rest of the first year of life, infants learn to trust in themselves: 'I can do; I am able.' In the next two years, they confirm that they are able to act in the world: 'I am worthwhile; I can contribute.' The overall goal, one that overshadows the particular goals of 'curriculum areas', is a profound self-esteem and a healthy, happy, strong self-image.

The Montessori classroom is prepared to help children accomplish their goals in their own manner, whether we call it work or play. Gradually the children reveal qualities for which they are not usually given credit, such as intense concentration and surprising attention span; exactness and precise movement; a sense of order; maximum effort even by very little ones; self discipline and respect for others; peacefulness and kindness; and an obvious joy in 'work'. The classroom is a prepared environment designed to support the child's need for purposeful activity. It is a children's house: the furniture is easily moved, pictures are hung at a child's eye-level, plants are easily watered by children. The sink is not a toy, but a real, child-sized sink. There are many carefully designed materials to meet the child's natural interest. The atmosphere is positive, supportive and non-competitive.

The Infant Toddler materials may look simple, but they are precisely designed, based on years of observation, experiment and study...

**Series I**

**Infant Object Permanence Boxes**

**Object Permanence Box With Tray**  
Item Number: 0.411.00



**Object Permanence Box With Drawer**  
Item Number: 0.412.00



**Imbucare Box With Large Cylinder**  
Item Number: 0.421.00



**Imbucare Box With Small Cylinder**  
Item Number: 0.422.00





**Imbucare Box With Cube**  
Item Number: 0.423.00



**Imbucare Box With Triangular Prism**  
Item Number: 0.424.00

**Imbucare Box With Rectangular Prism**  
Item Number: 0.425.00



## Imbucare Box With Flip Lid - 1 Slot

A rectangular box with 2 compartments and a flip lid with 1 slot. Repetition of the exercise provides the toddler with exploring the use of the hand, hand-eye coordination, finger and wrist movement as well as the experience of fitting objects into holes.

**Item Number: 0.426.00**



## Imbucare Box With Flip Lid - 4 Shapes

A rectangular box with 2 compartments and a flip lid with 4 cut-out geometric shapes. The child inserts the shapes in the correct holes and flips the lid over to expose the shapes. Repetition of the exercise is an introduction to basic geometric shapes and provides the toddler with exploring the use of the hand, the experience of fitting objects into holes, hand-eye coordination and finger and wrist movement.

**Item Number: 0.427.00**

### **Imbucare Box With Flip Lid - Knit Ball**

A rectangular box with 2 compartments and a flip lid with one hole. The child inserts the knit ball in the hole and flips the lid over to expose it. Repetition of the exercise provides the toddler with exploring the use of hand, hand-eye coordination, finger and wrist movement, as well as the experience of fitting objects into holes.

**Item Number: 0.419.00**



### **Imbucare Box With Knit Ball**

**Item Number: 0.432.00**





**Imbucare Peg Box**  
Item Number: 0.431.00

### **Imbucare Box With 3 Colored Knit Balls**

A box with a red, a yellow and a blue circle printed on the lid. The box houses 3 colored knit balls on strings, 2 stakes and 1 wooden slat with dowels. A rack is built on the box and the 3 knit balls are hung from the dowels. Use of this material provides the toddler practice in hand-eye coordination, recognition of color and the differences between two and three dimensional shapes.

**Item Number: 0.433.00**



## Series III

### Toddler Imbucare Boards

#### Imbucare Board With Knit Ball

A tray with a removable wooden divider board with 1 hole. The child inserts the ball through the hole where it 'disappears' behind the divider board. Use of this material provides the toddler with exploring the use of the hand, experiences of fitting objects into holes, hand-eye coordination and finger and wrist movement. May also be used with two children where they each sit at one side and 'pass' the ball back and forth. The bottom of the tray is covered in felt to reduce noise.

**Item Number: 0.430.00**



#### Imbucare Board With Disc

A tray with a removable wooden divider board with 1 slot. The child inserts the disc through the slot where it 'disappears' behind the divider board. Use of this material provides the toddler with exploring the use of the hand, experiences of fitting objects into holes, hand-eye coordination and finger and wrist movement. May also be used with two children where they each sit at one side and 'pass' the disc back and forth. The bottom of the tray is covered in felt to reduce noise.

**Item Number: 0.429.00**





#### Single Shape Puzzle Set

Four 1-piece puzzles: large circle, small circle, square, equilateral triangle.

**Item Number: 0.441.00**

#### Multiple Shape Puzzle Set

Two 3-piece puzzles: circle-square-triangle, and 3 sizes of circles.

**Item Number: 0.442.00**

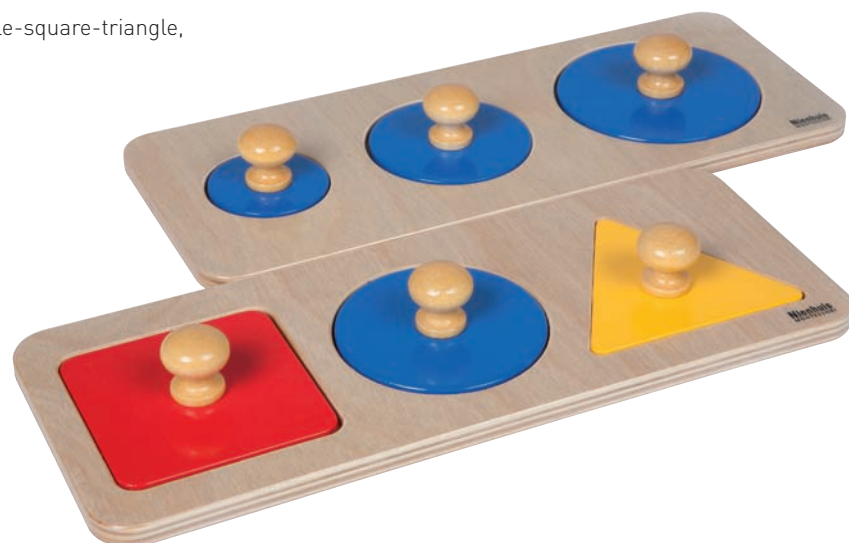

**Series V**

**Toddler Infilare Exercises**

**Cubes On Vertical Dowel**  
Item Number: 0.451.00



**Discs On Vertical Dowel**  
Item Number: 0.452.00



**Discs On Horizontal Dowel**  
Item Number: 0.453.00

Three Discs On A Vertical Dowel  
Item Number: 0.458.00



Colored Discs On Colored Dowels  
Item Number: 0.456.00





**Series VI**

**Toddler Supinated Wrist Movement**

**Horizontal Dowel Variation - Straight**  
Item Number: 0.454.00



**Horizontal Dowel Variation - Serpentine**  
Item Number: 0.455.00

## Balls On Small Pegs

A square wooden board with 4 small pegs that holds 4 balls of two different sizes. The balls invite the child to grasp and to discover the differing sizes. Placing the balls on the pegs is another new challenge for the infant. As the pegs seem to 'disappear' in the balls, the child experiences that the center hole in the ball disappears too, and the shape becomes whole.

**Item Number: 0.460.00**



## Ellipsoids On Small Pegs

A square wooden board with 4 pegs that holds 4 ellipsoids of the same size. Placing the ellipsoids on the pegs is a challenging task for the infant. As the pegs seem to 'disappear' in the ellipsoids, the child experiences that the center hole in the ellipsoid disappears too, and the shape becomes whole.

**Item Number: 0.457.00**

## Infant Toddler Dressing Frames

These dressing frames have been specially designed to be used by infant-toddler age children.

**Features include:**

- round edges
- a soft fabric which can be removed and washed
- simple fastenings, easy for young children to grasp

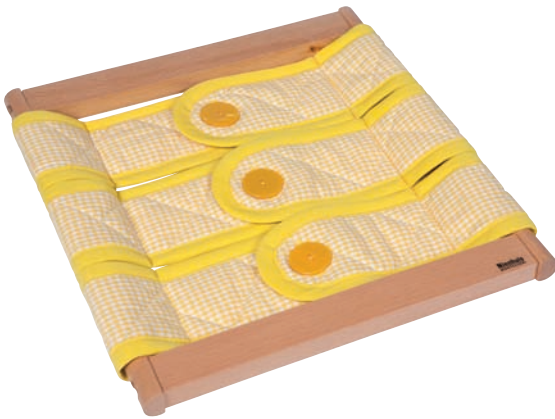

**Infant Toddler Dressing Frame: 3 Buttons**

Item Number: 0.465.00

**Infant Toddler Dressing Frame: Large Zipper**

Item Number: 0.466.00





**Infant Toddler Dressing Frame: Velcro**  
Item Number: 0.467.00



**Infant Toddler Dressing Frame: Snapping**  
Item Number: 0.468.00



**Infant Toddler Dressing Frame: Buckling**  
Item Number: 0.469.00

### **Thread Ring**

With this ring, the toddler practices his fine motor skills by putting the 'needle' through the holes in a sewing-like motion. The 3 different colors of the threads make it possible to create color combinations and geometric shapes. Ring diameter is 27 cm.

**Item Number: 0.409.00**

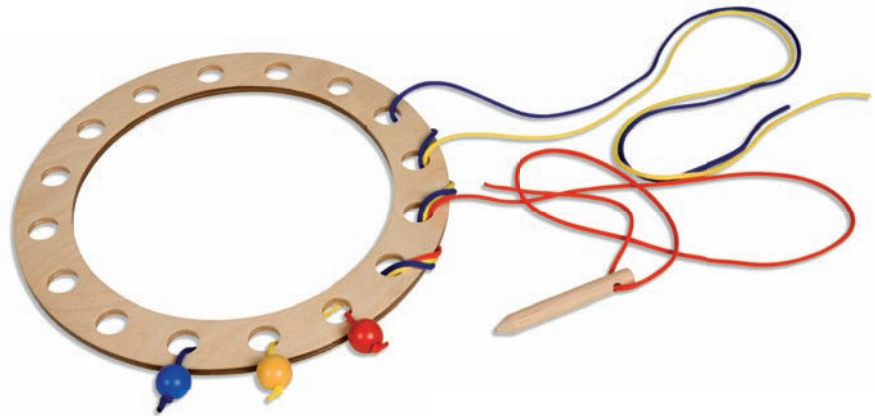

### **Braiding Board**

This material invites the child to learn braiding in an easy and simple way. Fastened on the wooden board are 3 rope-like strings in 3 different colors. Good for practice of the fine motor skills.

**Item Number: 0.407.00**





### Box With Sliding Lid

A box with 2 compartments and a sliding lid. The child places various objects in one or both compartments and slides the lid to cover or uncover them. Use of this material provides the toddler with exploring the use of the hand, finger and wrist movement as well as object permanence. [Objects not included].

**Item Number: 0.428.00**



### Box With Bins

**Item Number: 0.461.00**

### Infant Toddler Mirror

Infants and toddlers are fascinated with mirrors. Through observing, they learn about themselves, about their own movements and they discover their identity. A sturdy acrylic mirror (127 x 69 cm) surrounded by a wooden frame. A carrying handle has been crafted in the frame for easy transportation.

**Item Number: 1.160.00**



### Sorting Tray

A tray used for the children to sort all kinds of things from within their environment. Good for practice of the fine motor skills, color discrimination and sorting (Objects not included).

**Item Number: 0.406.00**

### 3D Object Fitting Exercise

By eight or nine months, an infant can explore putting a wooden egg in a cup and taking it out again. Putting a ball in a cup is a new experience, because the child has to turn over the cup to remove the ball. Putting a cube in a box is even more challenging because it is necessary to line up the corners of the box and cube for success. These activities enhance hand-eye coordination and give the infant an opportunity for his two hands to work together in a meaningful way. Includes: 2 cups, 1 egg, 1 ball, 1 box, 1 cube and 1 tray for material presentation and storage.

**Item Number: 0.435.00**



## Infant Bell

Not until three to five months does a child have the ability to intentionally reach and grasp. At this point, he can purposefully close his hand around an object and shake the object without using wrist movement. This wooden bell challenges the child to grasp and move in this manner while at the same time, ringing the bell, which encourages repeat action.

**Item Number: 0.477.00**



## Interlocking Discs

A set of 2 interlocking wooden discs. At about six months the infant begins to examine objects through hand-to-hand transfer, purposefully moving an item from the right hand to the left hand and from the left hand to the right. Through this transfer he creates different experiences with the same object. Hand-to-hand transfer of objects has implications for the development of the right and left sides of the brain. Disc diameter: 5 cm.

**Item Number: 0.485.00**

## Teething Ball

A rubbery-textured ball with knobs on it. As the infant 'chews' on the ball, it helps to relieve the pain associated with growing the first teeth.

**Item Number: 0.486.00**



## Wooden Toddler Trike

Seat Height: 9.1 inches. Ages: 0-3 years.

**Item Number: 523.104**





# Practical Life

When children come into the world, their first function is to adapt to their environment so that they may become a member of the human group to which they uniquely belong. The mechanism by which this occurs is one of absorption of all the elements surrounding them, obeying vital inner directives common to all children.

The first elements to be perceived and absorbed into the child's very being are the numerous levels of order prevailing in their home. The daily activities undertaken by adults in establishing, maintaining and embellishing the living environment; the care of others and the care of self; the ceremony and ritual of hospitality; these are all intensely fascinating to the child because they are aesthetic, logical and understandable. The quotidian rites of everyday existence are comforting and provide a security necessary for the child's development.

The Exercises of Practical Life are classified under the headings of Preliminary Exercises, Care of the Environment, Care of the Person, Grace and Courtesy, and Movement. There are materials for each of these areas adapted to the children's size, interests and capabilities. Fundamentally, these exercises are the same all over the world, but distinct in their expression in different societies since they reflect the domestic life of the particular culture where the Montessori environment is established.

The Exercises of Practical Life, which are the foundation of a Montessori environment, provide a sane and wholesome range of activities which allow the children to develop control and coordination of movement, awareness of their environment, orderly thought patterns, independent work habits, responsibility, and many other human characteristics which can only be attained by spontaneous, purposeful work.

### The Complete Practical Life Stand

Set includes: 1 shoe polishing set, 1 small dusting brush, 1 indoor broom: soft black, 1 rug beater, 1 dust pan, 1 dust brush with handle, 1 scrubber and 1 squeegee.

**Item Number: 1.727.00**



**Indoor Broom: Soft Black**  
**Item Number: 4.021.00**

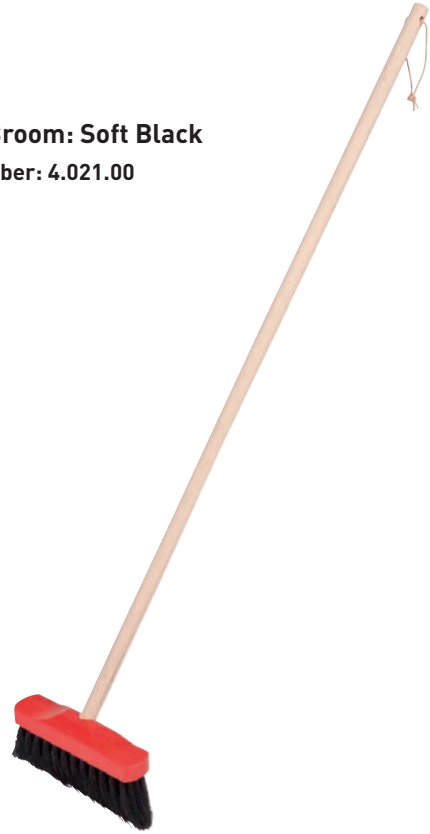

**Indoor Broom: Coarse Brown**  
**Item Number: 4.022.00**



**Outdoor Broom**  
Item Number: 4.023.00



**Rug Beater**  
Item Number: 4.025.00



**Scrubber**  
Item Number: 4.024.00



**Squeegee**  
Item Number: 4.029.00





**Dust Brush With Handle**  
Item Number: 4.042.00

**Dust Pan**  
Item Number: 4.045.00



**Shoe Polishing Brush Set: 4 Brushes**  
Item Number: 4.014.00

**Small Dusting Brush**  
Item Number: 4.015.00



## Wooden Trays

Wooden Trays for a variety of practical life exercises, i.e.: polishing exercises, folding and pouring. The trays are also suitable for use in all areas of the prepared environment.



**Wooden Tray Small: Set Of 2**  
Item Number: 0.475.00

**Wooden Tray Large**  
Item Number: 0.476.00



## Dressing Frames



**Buttoning Frame With Small Buttons**  
Item Number: 0.001.00



**Buttoning Frame With Large Buttons**  
Item Number: 0.002.00



**Bow Tying Frame**  
Item Number: 0.003.00



**Lacing Frame**  
Item Number: 0.004.00



**Hook And Eye Frame**  
Item Number: 0.005.00



**Safety Pin Frame**  
Item Number: 0.006.00



**Snapping Frame**  
Item Number: 0.007.00

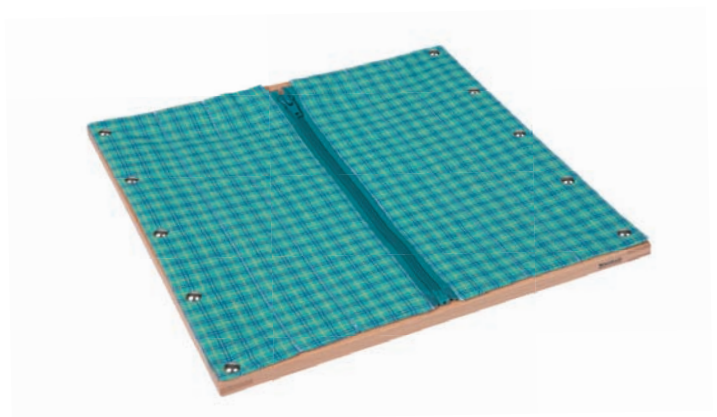

**Zipping Frame**  
Item Number: 0.008.00



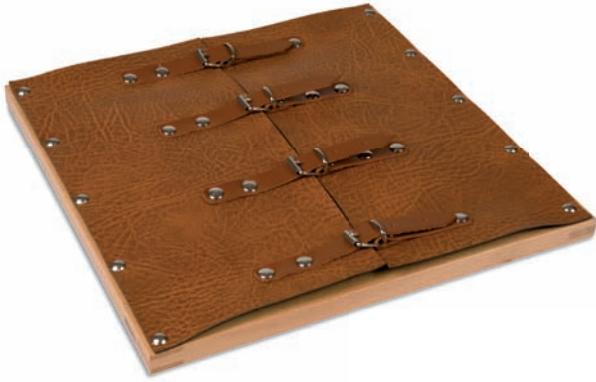

**Buckling Frame**

Item Number: 0.009.00



**Shoe Buttoning Frame**

Item Number: 0.010.00

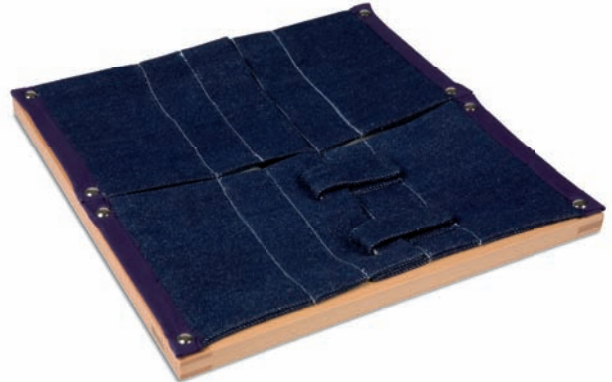

**Velcro™ Frame**

Item Number: 0.012.00



**Shoe Lacing Frame**

Item Number: 0.011.00

**Dressing Frames Stand**

The Dressing Frames Stand is freestanding to occupy minimum floor space while allowing the child easy access to the 12 Dressing Frames (frames not included).

**Item Number: 1.632.00**



### Cutting And Scissor Tray

An all-inclusive set for cutting exercises in the classroom. Includes: a wooden tray and small box, a pair of scissors and several scissors exercise sheets. See item 5.677.00 Scissors Exercises to order additional sheets.

**Item Number: 0.400.00**



### Glue And Paste Box

An all-inclusive set for gluing and pasting exercises in the classroom. Includes: a wooden box with 6 compartments, a glue/paste brush and a glass jar with lid. The lid of the box has a cutout hole that holds the jar upright to avoid spilling the contents.

**Item Number: 0.401.00**



### Sorting Tray

A tray used for the children to sort all kinds of things from within their environment. Good for practice of the fine motor skills, color discrimination and sorting (Objects not included).

**Item Number: 0.406.00**



## Finger Puppets

6 different sets: Farm, Woods, Jungle, Sea, Arctic and Garden. Each set contains 8 different hand-knit finger puppets contained in a lined knit pouch with zipper top. The pouch has snaps on the outside for attaching the puppets. A Fair Trade Product hand made in Anyi Bolivia.



**Finger Puppets - Farm**  
Item Number: 5.100.00



**Finger Puppets - Woods**  
Item Number: 5.101.00

**Finger Puppets - Jungle**  
Item Number: 5.102.00



**Finger Puppets - Sea**  
Item Number: 5.103.00



**Finger Puppets - Arctic**  
Item Number: 5.104.00



**Finger Puppets - Garden**  
Item Number: 5.105.00

### Hand Washing Table

This table is designed to teach children hand washing. The appropriate size of the table aids in the learning process, as well as promotes independence – 'they can do it themselves'. The table has two metal bowls: a small one for holding a bar of soap and a larger one for the water. The dimensions are: 68 x 52 x 45 cm. Additional hand washing equipment is not included.

**Item Number: 1.826.00**



## Dish Washing Table

This table is designed to teach children dish washing. The appropriate size of the table aids in the learning process, as well as promotes independence – 'they can do it themselves'. The table has two metal bowls: one for water, the other for soap. The dimensions are 150 x 52 x 45 cm. Additional dish washing equipment is not included.

**Item Number: 1.825.00**







# Sensorial

The Sensorial Materials have been given many names: Materialized Abstractions, Keys to the Universe, Paths to Culture... These multiple denominations are perhaps indicative of the enthusiasm the materials evoke in people who know them well. They are deceptively simple in appearance and totally satisfying to the developing child.

The reason for the success and popularity of these materials is that they allow the children to undertake such activities as all children undertake, spontaneously. Given the opportunity, with or without specialized materials, children will sort things by size, shape, color, touch, sound, temperature and weight. They will grade from dark to light, and from large to small. The Montessori Sensorial apparatus allows them to classify sensorial impression in an organized, orderly and scientific manner as well as they allow for individual work and for repetition.

The Sensorial Materials are mathematically graded; they isolate one quality only, keeping the remaining characteristics identical and are limited in both scope and quantity. This makes it possible for the children to abstract the concept made concrete in each piece of material, to name it, and then to apply it to the environment. Moreover, they have a built in control of error. Thanks to this control of error, the children acquire the habit of working independently, unafraid of making mistakes, becoming comfortable with the fact that errors are essential to the process of learning. And, incidentally, this establishes a tendency towards intellectual honesty.

### The Pink Tower

This series of cubes develops visual discrimination of size in 3 dimensions. Exploration with this material prepares the child for mathematical concepts in the decimal system, geometry and volume. The Pink Tower consists of ten wooden cubes painted pink, increasing increments from 1 cm<sup>3</sup> to 1000 cm<sup>3</sup>.

**Item Number: 0.024.00**

### Stand For Pink Tower

A wooden display stand, finished with a white stain.

**Item Number: 0.024.10**



### Box With Cubes For Pink Tower

A box with 273 wooden cubes (1 x 1 x 1 cm) in a natural wood finish. Used to compare and calculate the volume of the cubes of the pink tower.

**Item Number: 0.024.20**



## The Brown Stair

This series of prisms demonstrates to the child the change in width (breadth), while the length remains constant. Practice with The Brown Stair indirectly prepares the child for concepts in plane geometry, area and volume. The hardwood prisms are crafted in precise progressions from 1 x 1 x 20 cm to 10 x 10 x 20 cm.



**The Brown Stair: Clear Lacquer**  
Item Number: 0.025.00

**The Brown Stair: Brown Lacquer**  
Item Number: 0.025.50



## Box With Prisms For Brown Stair

Box with 19 wooden prisms (1 x 1 x 20 cm) in a natural wood finish. Used to compare and calculate the volume of the prisms of the brown stair.

**Item Number: 0.025.20**



## Cylinder Blocks

The Cylinder Blocks introduce the child to the first stage of visual discrimination of size. Made of solid beechwood with a satin smooth lacquer finish. Recently re-designed, each block has slightly rounded edges and each cylinder is individually sanded and lacquered.

### Cylinder Block No. 1

Cylinders progress in height and diameter from small to large.

**Item Number: 0.019.00**



### Cylinder Block No. 2

Cylinders progress in diameter from thin to thick.

**Item Number: 0.020.00**



### Cylinder Block No. 3

Cylinders diminish in height yet increase in diameter from tall to thin and short to thick.

**Item Number: 0.021.00**



### Cylinder Block No. 4

Cylinders progress in height from short to tall with the diameter remaining constant.

**Item Number: 0.022.00**



**Stand For Cylinder Blocks**  
Item Number: 1.900.00



## Set Of Knobless Cylinders

The Knobless Cylinders are the final stage in the dimensional material where the child, based upon his ability to discriminate, places the individual sets of cylinders in the correct order. Each set of 10 cylinders are contained in a separate beechwood box with the lid painted the same color as the cylinders.

Item Number: 0.023.00

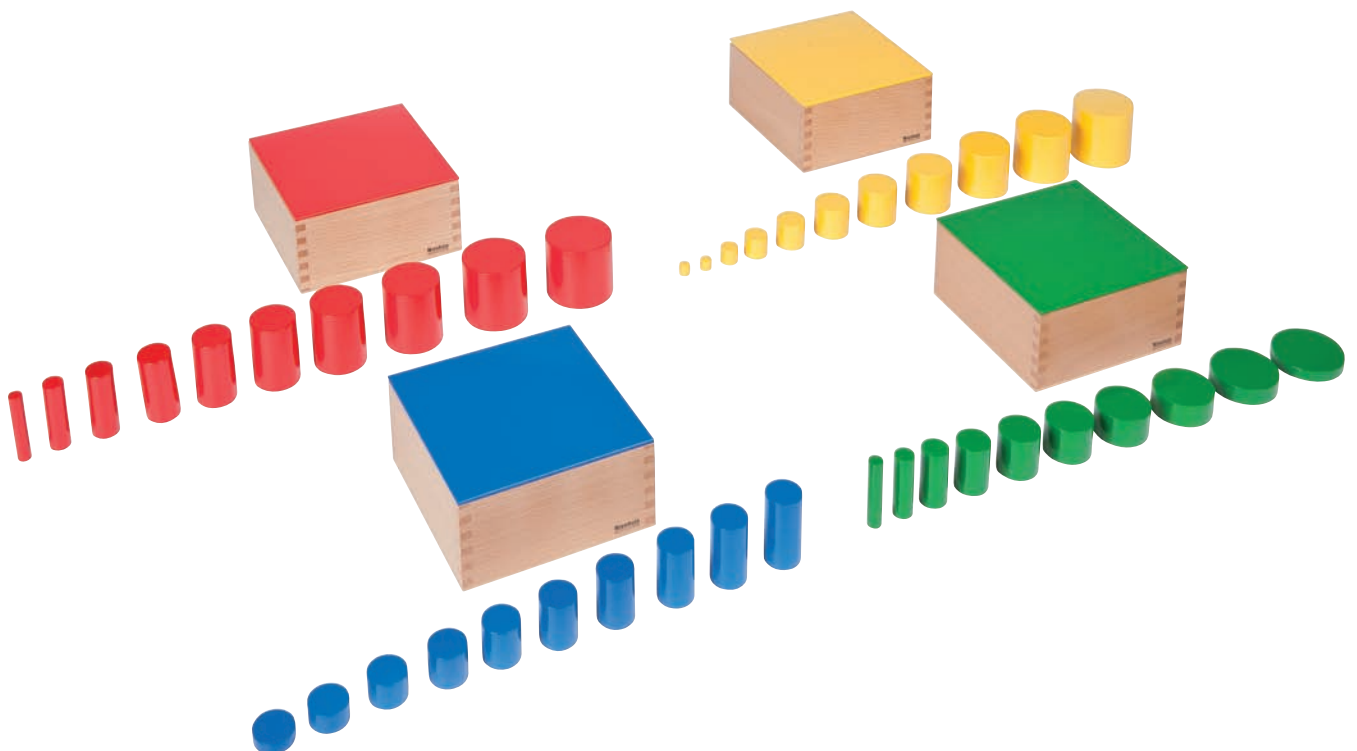

### **The Red Rods**

The Red Rods develop visual discrimination of length, while height, color and width remain constant. Ten solid wooden rods increasing in length in equal units from 10 cm to 1 meter.

**Item Number: 0.026.00**

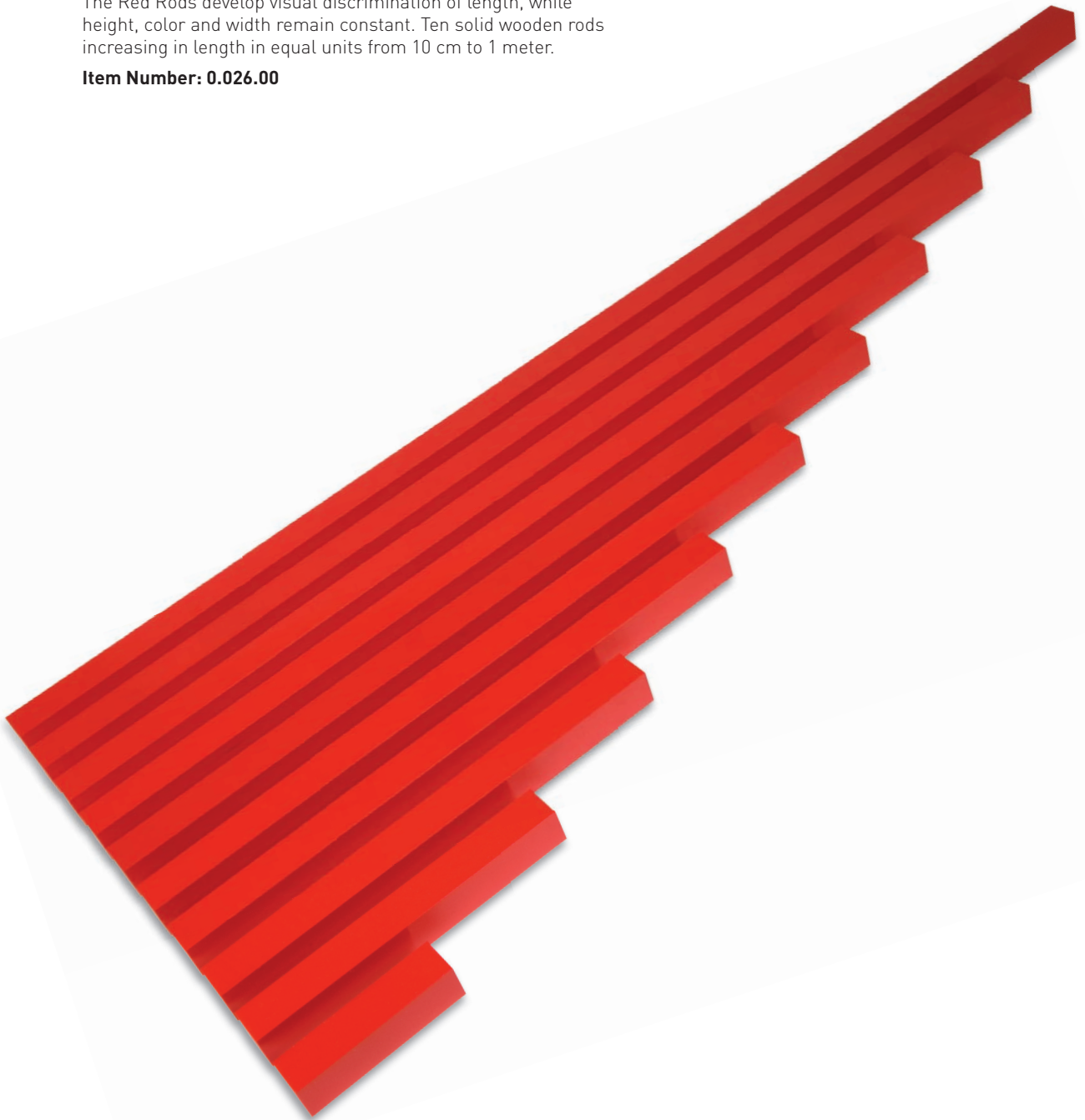

## Mystery Bag: Familiar Items

A cloth bag containing familiar objects.

**Item Number: 0.017.70**



## Mystery Bags: Geometric Shapes

A set of 2 cloth bags that each contain a set of small geometric solids for matching.

**Item Number: 0.017.40**

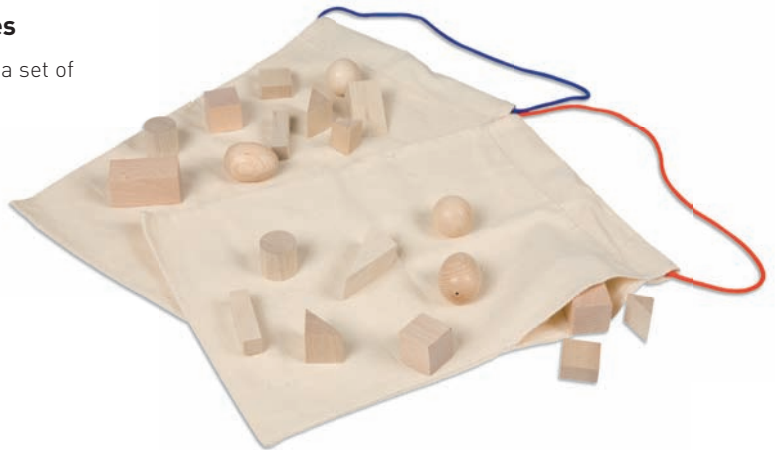

## Mystery Bags: Empty

A set of 2 cloth bags.

**Item Number: 0.017.30**

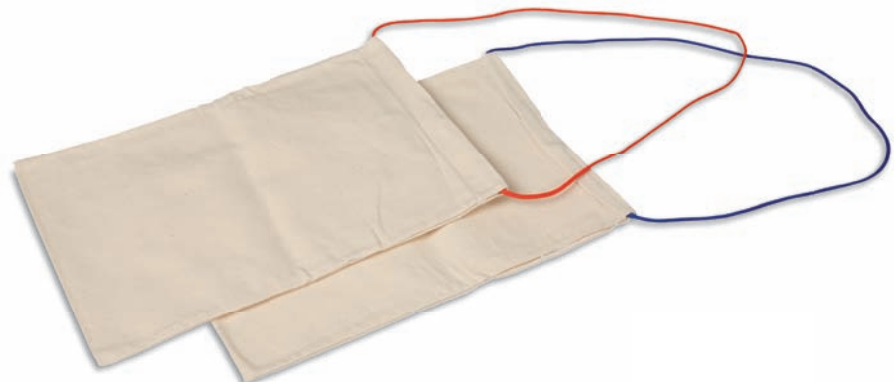



### **First Box Of Color Tablets**

The First Box Of Color Tablets introduces color and refines the chromatic sense. Consists of 6 tablets - a pair each of the primary colors: red, yellow and blue.

**Item Number: 0.051.00**



### **Second Box Of Color Tablets**

The Second Box Of Color Tablets introduces secondary and tertiary colors as well as, the language of colors. The box contains 22 tablets, a pair each of: red, blue, yellow, orange, green, purple, brown, pink, gray, black and white.

**Item Number: 0.052.00**

## Third Box Of Color Tablets

The Third Box Of Color Tablets introduces the final stage in color discrimination - that of grading. The box contains 63 tablets representing nine colors in seven graded shades of: red, blue, yellow, green, purple, orange, brown, pink and gray.

**Item Number: 0.053.00**



## Color Box Of 32 Pairs

A supplemental box of colors containing 4 matching shades of each of the colors: red, blue, yellow, purple, green, brown, pink and gray.

**Item Number: 0.053.A0**

### **Fabric Box**

Through touch, the child pairs the fabrics according to varying textures. Includes: fabrics in cotton, wool, jute, silk, leather and synthetic material and a beechwood box with lid.

**Item Number: 0.014.50**



### **Baric Tablets**

The Baric Tablets introduce and refine the concept of the baric sense. While blindfolded, the child endeavors to discern the weight of the tablets. Error is controlled by the color of the wooden tablets, the lightest color being the lightest weight to the darkest color being the heaviest weight.

**Item Number: 0.017.00**

### **Blindfold**

This cloth blindfold has a comfortable opening for the nose and a Velcro fastener so the child may put it on without assistance.

**Item Number: 0.017.A0**



## Rough And Smooth Boards Set

This set of 3 boards forms the introductory materials for development of the tactile sense and prepares the hand for writing. The first board introduces the contrast of rough and smooth. The second board helps to coordinate finger movement and builds dexterity. The third board introduces gradations of texture from fine to coarse. Each board is 24 x 13 cm with sandpaper strips mounted on smooth wood.

**Item Number: 0.012.A0**

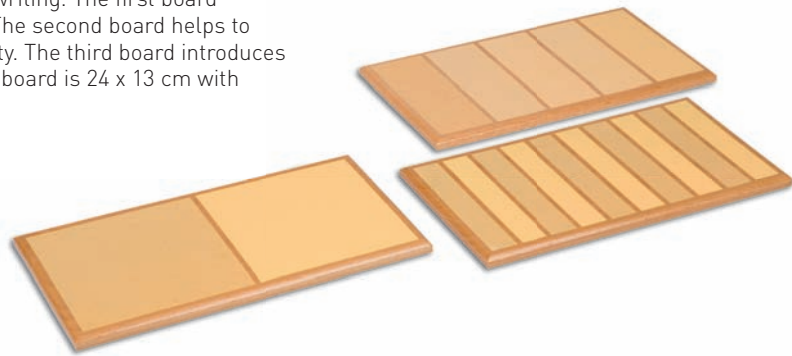

## Smooth Gradation Board

This board introduces the child to gradations of smoothness.

**Item Number: 0.012.40**

## Smooth Gradation Tablets

5 pairs of varying smooth surfaces mounted on solid beechwood tablets 12 x 9 cm. Includes a box for storage.

**Item Number: 0.014.40**



## Rough Gradation Tablets

5 pairs of varying grades of sandpaper mounted on solid beechwood tablets 12 x 9 cm. Includes a box for storage.

**Item Number: 0.014.00**



### Pressure Cylinders

The Pressure Cylinders provide experiences in pairing and grading degrees of pressure. By pressing the spring-loaded plungers, the child senses the difference in resistance pressure. The set includes a wooden tray that holds 6 matching pairs of pressure cylinders. Designed by George Russell.

**Item Number: 0.013.00**



### Thermic Tablets

The Thermic Tablets are used to cultivate the ability to discriminate thermic qualities. Consists of a wooden box divided into 6 compartments containing six pairs of 8 x 4 cm tablets made from felt, wood, steel, cork, glass and slate.

**Item Number: 0.018.A0**

### Thermic Bottles

Thermic sense is refined through exercises of pairing and grading. The bottles are chrome-plated copper for conductivity, and are identical in appearance to prevent visual matching. The set includes a wooden tray that holds 8 metal bottles with screw-on tops.

**Item Number: 0.018.00**



## Tasting Exercise

The Tasting Exercise is used to refine the gustatory sense. The bottles are prepared, by the teacher, with the basic tastes of sweet, sour, salty and bitter then are sampled and matched by the child. 8 tasting bottles and a working tray are included.

**Item Number: 0.015.50**



## Blindfold

This cloth blindfold has a comfortable opening for the nose and a Velcro fastener so the child may put it on without assistance.

**Item Number: 0.017.A0**



## Smelling Bottles

The Smelling Bottles are used to refine the olfactory sense through matching. The teacher prepares the bottles with a variety of pairs of scents. The set consists of a wooden tray that holds 12 glass bottles - 6 colored dark gray, 6 colored light gray.

**Item Number: 0.015.00**

## Sound Boxes

The Sound Boxes develop auditory discrimination through exercises in pairing and grading a series of sounds. This item consists of two sets of 6 sealed wooden cylinders graded from very soft to loud that contain materials that make a distinctive sound when shaken.

**Item Number: 0.016.00**



### Constructive Triangles

The Constructive Triangles give the child practical experience in plane geometry. The set consists of: 2 rectangular boxes, 1 triangular box, 1 small hexagonal box, and 1 large hexagonal box, each containing triangles of differing size, shape and color.

**Item Number: 0.049.00**

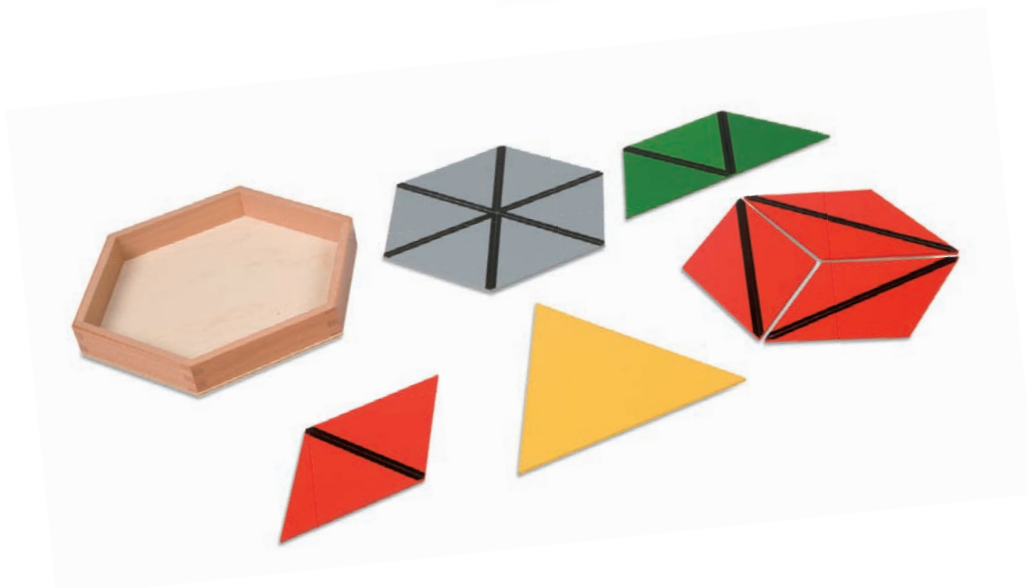
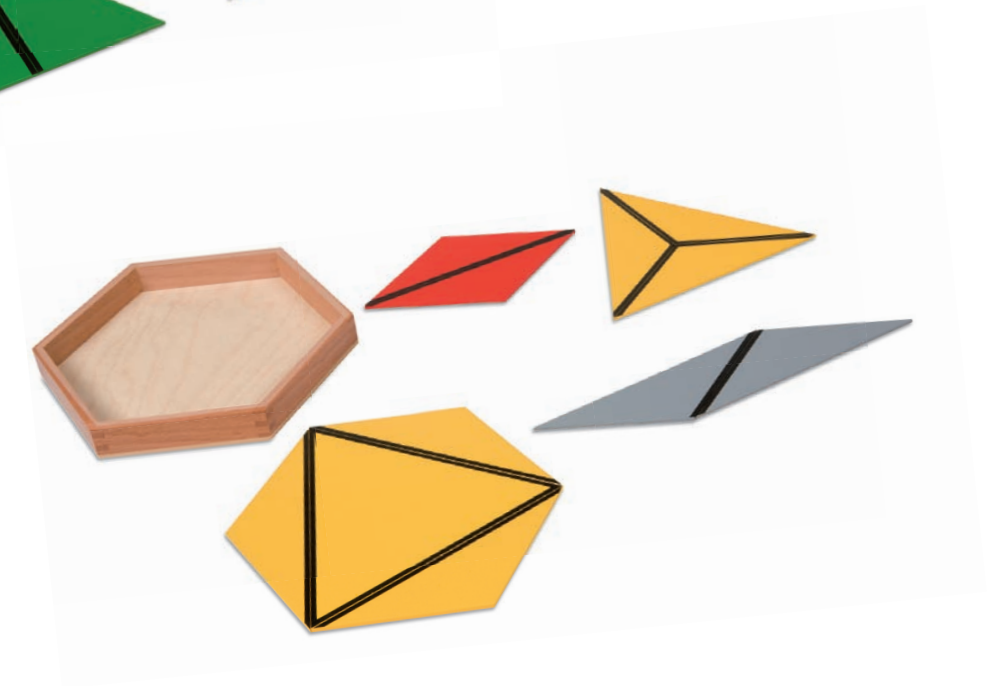

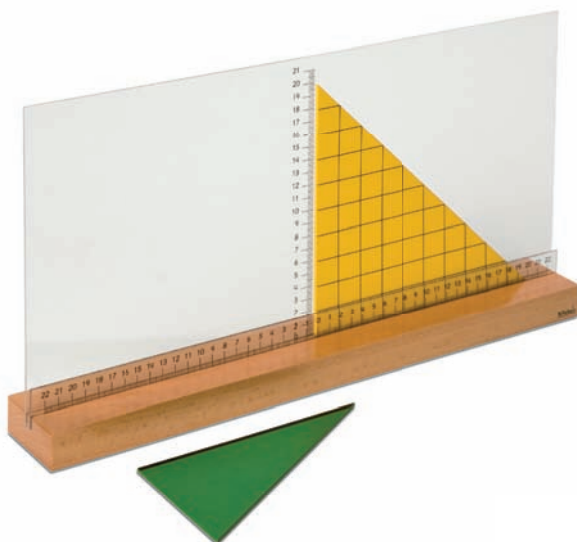
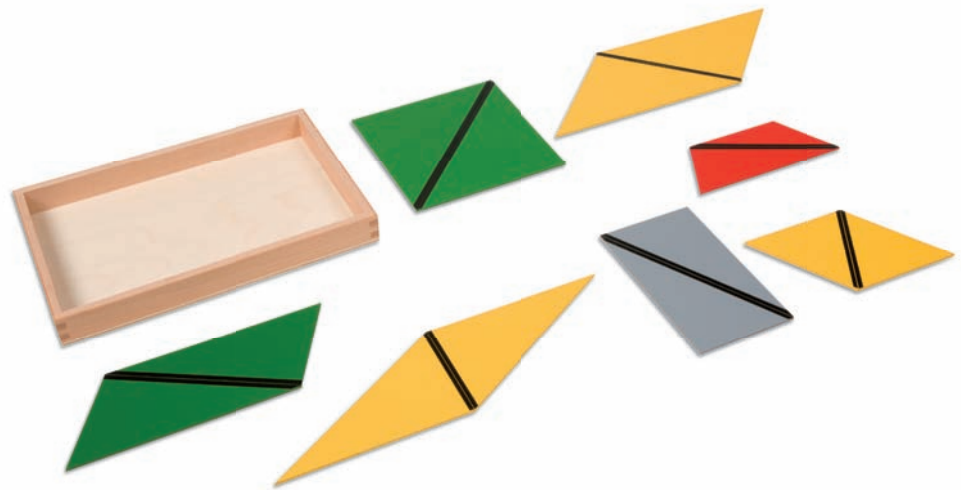
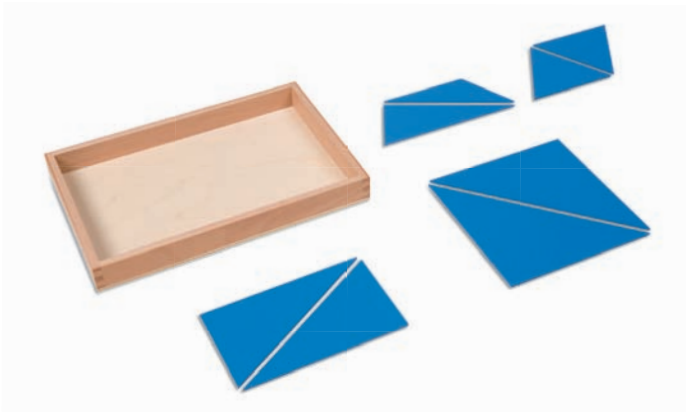

## Stand For Height

A stand for plane geometric form exploration that facilitates the measurement of height of the Constructive Triangles.

**Item Number: 0.126.00**



### Constructive Blue Triangles

The Constructive Blue Triangles are used in the elementary Montessori classroom to explore equivalency, congruency and similarity. Includes 12 right-angled scalene triangles and a beechwood box with lid.

**Item Number: 0.049.F0**

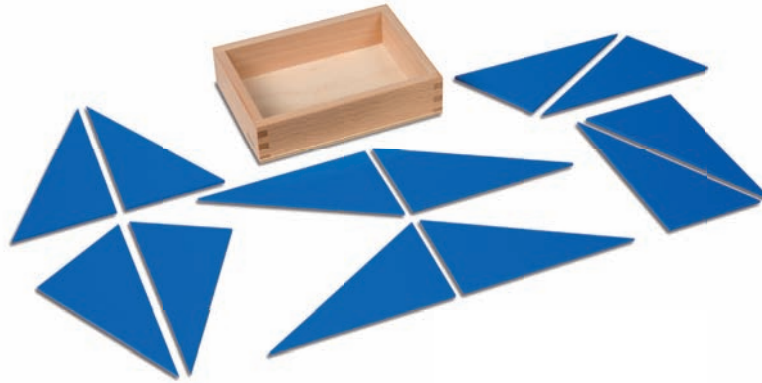

### Constructive Blue Triangles Activity Set

Additional exercises for use with the Constructive Blue Triangles. Includes: exercise cards, divider tabs and a wooden box for storage.

**Item Number: 0.611.01**



### Circles, Squares And Triangles

The sets of Circles, Squares And Triangles provide the possibility for the child to explore and experiment with the three basic geometric shapes. The three shapes are represented in 3 colors - red, yellow, blue, and are graded from 1 to 10 cm in size. Each color is stored in an individual box with a lid.

**Item Number: 0.045.00**



## Inscribed And Concentric Figures: Plastic

The precisely cut geometric shapes offer the child the possibility to explore inscription, concentricity and gradation. The material is contained in a box with lid which has 3 compartments for storage of: a graded set of 6 circles, green on one side and red on the other; a graded set of 6 squares, green on one side and red on the other; 2 graded triangles and 2 graded circles, blue on one side and yellow on the other.

**Item Number: 0.045.50**



## Inscribed And Concentric Figures: Paper

The paper figures extend the child's experience with the exercises of the Inscribed And Concentric Figures by encouraging pasting activities. In 8 vibrant colors, there are 6400 glossy paper pieces for pasting.

**Item Number: 0.045.70**



## Inscribed And Concentric Figures Activity Set

Additional exercises for use with the Inscribed And Concentric Figures material. Includes: exercise cards, divider tabs and a wooden box for storage.

**Item Number: 0.619.01**



### The Demonstration Tray

The Demonstration Tray is used with The Geometric Cabinet to introduce plane geometric shapes in isolation.

**Item Number: 0.038.00**

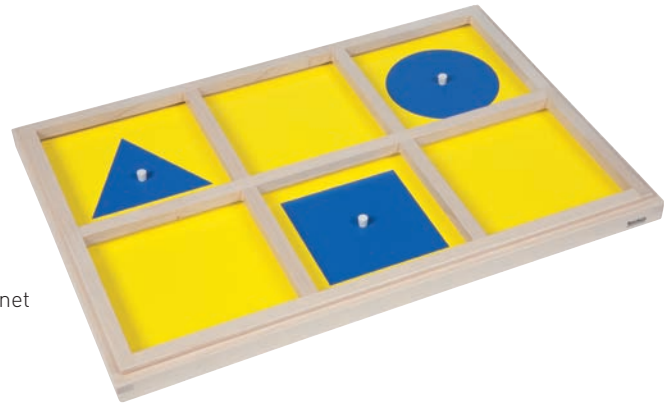

### Geometric Form Cards For The Demonstration Tray

The wooden tray contains 9 geometric form cards for use with the three basic shapes of the Demonstration Tray. Each shape is represented by a solid, a thick lined and a thin lined form card.

**Item Number: 0.039.A0**



### The Geometric Cabinet

The Geometric Cabinet introduces the child to plane geometry. A six-drawer cabinet containing 35 geometric insets and frames.

**Item Number: 0.037.00**

## Geometric Form Cards

The Geometric Form Cards consist of three series of 35 cards that correspond to the figures contained within The Geometric Cabinet. Series include 7 each of solid, thick lined and thin lined plastic cards.

**Item Number: 0.039.00**

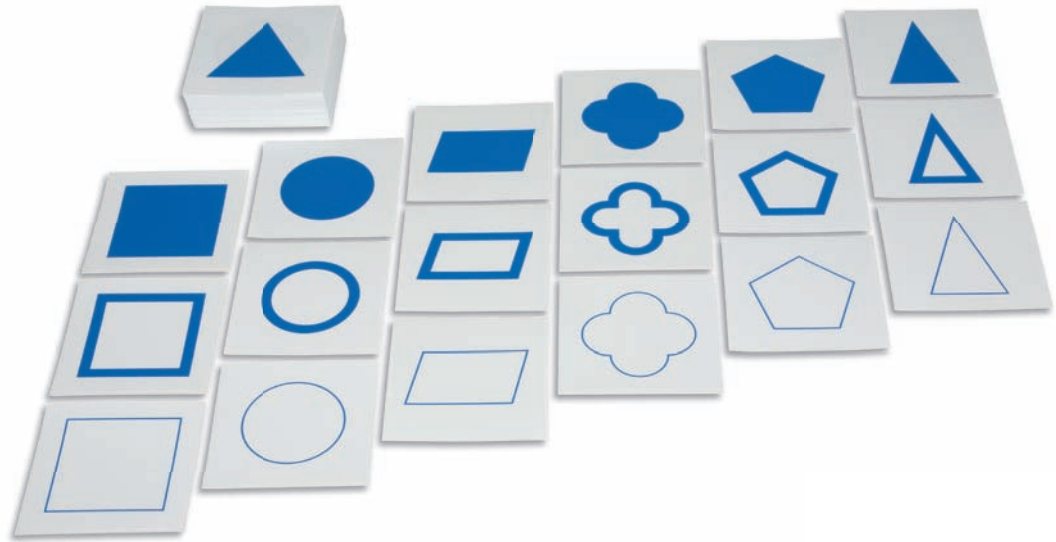

## Geometric Form Card Box

A box with 3 dividers used for storing the Geometric Form Cards.

**Item Number: 0.040.A0**



## Geometric Form Card Cabinet

A cabinet with 6 shelves used for storing the Geometric Form Cards.

**Item Number: 0.040.00**



**Geometric Cabinet Activity Set**

Additional exercises for use with The Geometric Cabinet. Includes: exercise cards, divider tabs and a wooden box for storage.

**Item Number: 0.610.01**

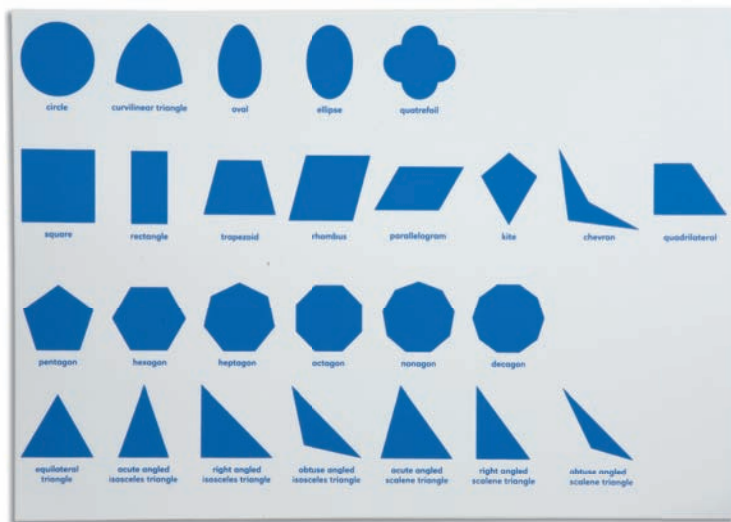

**Geometric Cabinet Control Chart**

A control chart for the Geometric Cabinet, showing the 26 geometric shapes. Printed in blue on white plastic.

**Item Number: 0.037.C1**

**Geometric Cabinet Control Book**

A book for use with the Geometric Cabinet and The Geometric Cabinet Activity Set. Coil bound, plastic pages.

**Item Number: 0.037.B1**

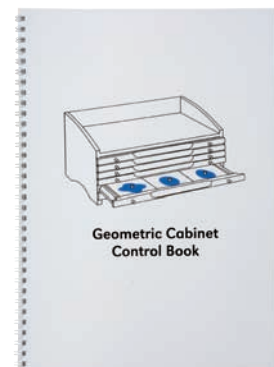

## Geometric Cabinet Nomenclature Cards

2 sets of nomenclature cards. 1 set with separate labels and 1 control set labeled at the bottom. Printed in blue on white card stock.

**Item Number: 5.608.00**

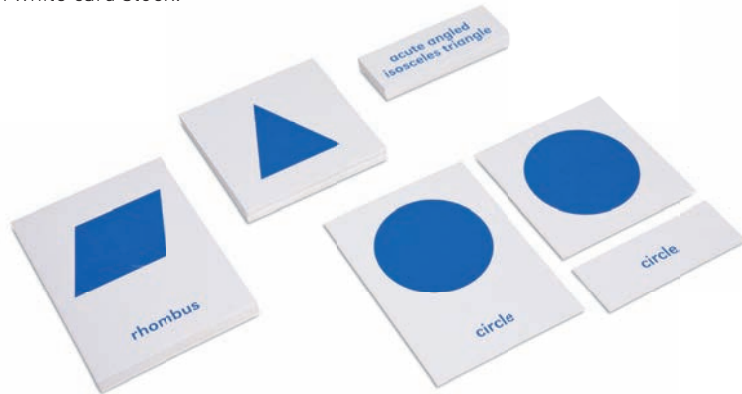

## Geometric Beginning Labels

36 labels for the plane geometric shapes in The Geometric Cabinet.

**Item Number: 5.610.00**

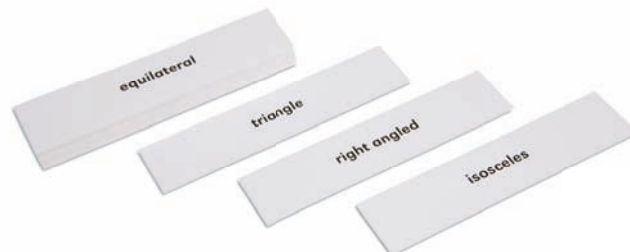

## Geometric Cabinet Advanced Triangle Labels

40 labels for labeling the sides and angles of the shapes in The Geometric Cabinet.

**Item Number: 5.611.00**

### The Geometric Solids

The 10 Geometric Solids introduce the child to solid geometry. 3 clear stands for the curved-sided solids are included.

**Item Number: 0.048.00**

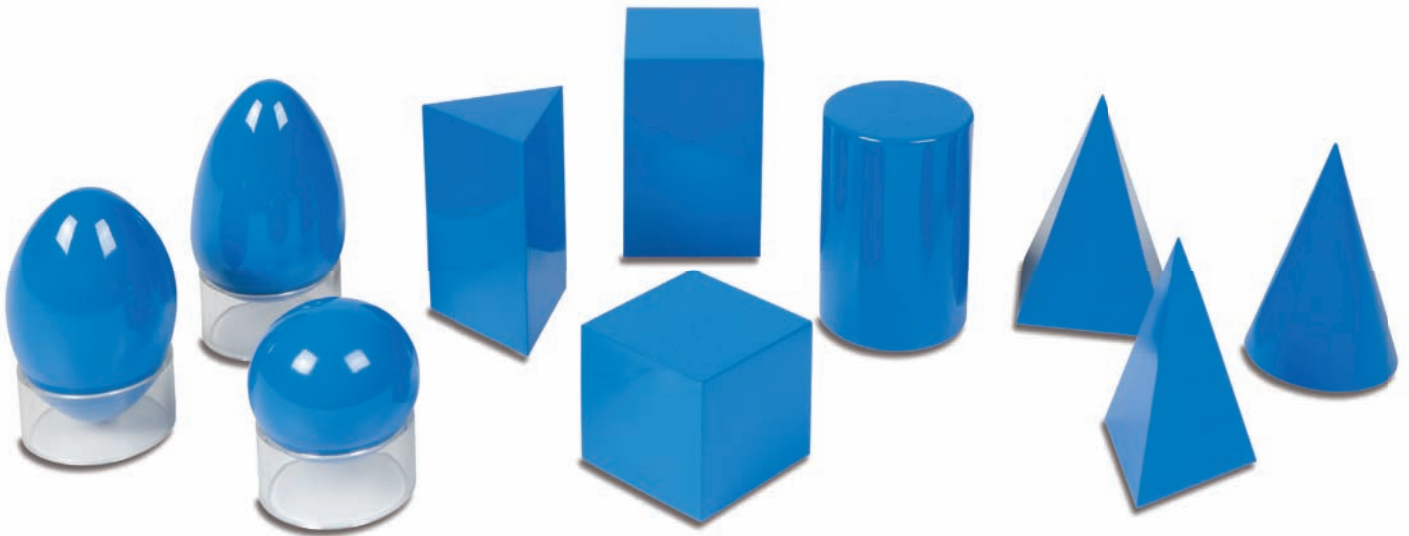

### Geometric Solids Basket

**Item Number: 0.048.B0**



### Geometric Cards

A set of 7 thin, blue lined, plastic geometric cards.

**Item Number: 0.048.C0**

### Geometric Plane Figures With Box

This material is used to link the three-dimensional Geometric Solids to their corresponding two-dimensional plane figures. Includes 5 plane figures with box.

**Item Number: 0.048.A0**





## Geometric Solids Activity Set

Additional exercises for use with The Geometric Solids. Includes: exercise cards, divider tabs and a wooden box for storage.

**Item Number: 0.609.01**

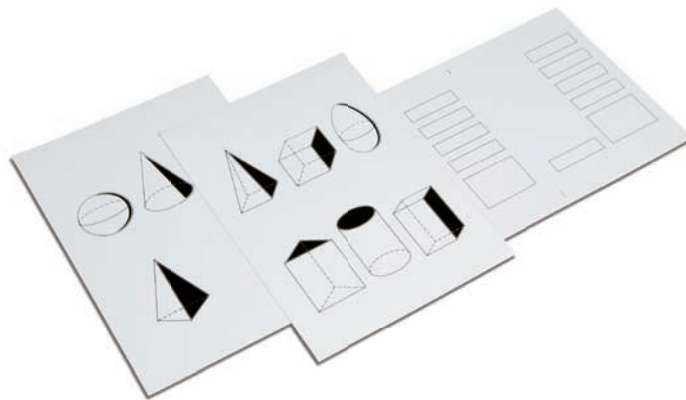

## Geometric Solids Copy Masters

A set of plastic cards with the Geometric Solid illustrations for copying.

**Item Number: 0.048.E0**



## Commands For The Geometric Solids

63 commands for activities with The Geometric Solids and related solid geometric forms in the environment.

**Item Number: 5.615.00**

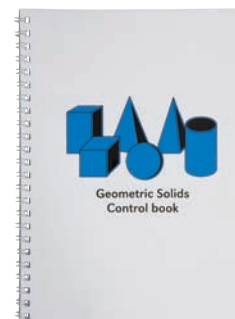

## Geometric Solids Control Book

A book to be used with The Geometric Solids and The Geometric Solids Activity Set. Coil bound, plastic pages.

**Item Number: 0.048.D1**





**Geometry/Biology Cabinet (69 cm)**

A cabinet designed to store all the basic geometry or biology material. The dimensions are 53 x 69 x 46 cm, which is suitable for children up to 6 years of age.

**Item Number: 1.822.00**



**Geometry/Biology Cabinet (101 cm)**

A cabinet designed to store and/or display the basic geometry or biology material. The dimensions are 53 x 101 x 46 cm, which is suitable for children from 3 to 12 years of age.

**Item Number: 1.875.00**



## Binomial Cube

The Binomial Cube is a concrete representation of the algebraic formula  $(a+b)^3$ . The cubes and prisms represent the factors of the equation. The primary Montessori child explores the Binomial Cube as a sensorial activity of visual discrimination of color and form. The Binomial Cube is contained in a wooden box with lid.

**Item Number: 0.131.00**

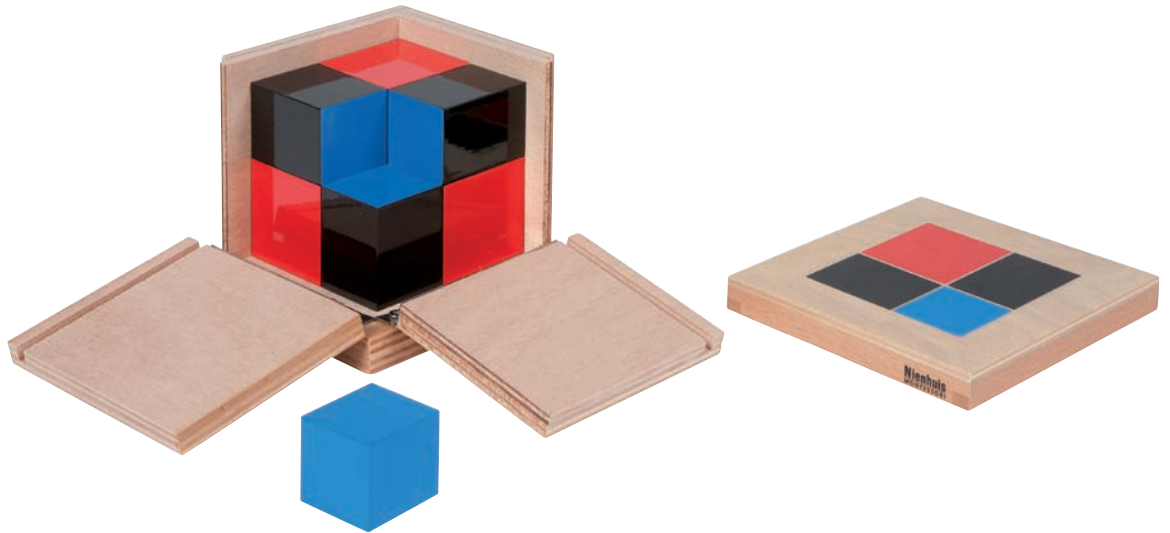

## Trinomial Cube

The Trinomial Cube is a concrete representation of the algebraic formula  $(a+b+c)^3$ . The cubes and prisms represent the factors of the equation. The primary Montessori child explores The Trinomial Cube as a sensorial activity of visual discrimination of color and form. The Trinomial Cube is contained in a wooden box with lid.

**Item Number: 0.132.00**





**Bells Set**

The set consists of 13 pairs of bells that comprise the chromatic scale beginning at "c" (do). One bell of each pair is either black or white and the other is natural wood. 2 bell mallets and 1 damper is included.

**Item Number: 0.063.A0**



**Bell Damper**

**Item Number: 0.063.G0**



**Bell Mallet**

**Item Number: 0.063.F0**



**Montessori Music: Sensorial Exploration And Notation With The Bells**

An illustrated handbook with detailed instructions for sensorial presentations and notation introduction. 26 pp, heavy stock, 1999 ed. Jean K. Miller, Ph.D.

**Item Number: 5.350.00**

**Bells Support Materials Set**

A complete set of printed cards, labels, control strips and control booklets for use with the book "Sensorial Exploration and Notation with the Bells". Contains: major scale pattern cards, nomenclature cards, grading cards, description cards, and control strips and booklets.

**Item Number: 5.682.00**



## Bells Keyboards

2 color-coded keyboards upon which to arrange the bells in chromatic order.

**Item Number: 0.063.B0**

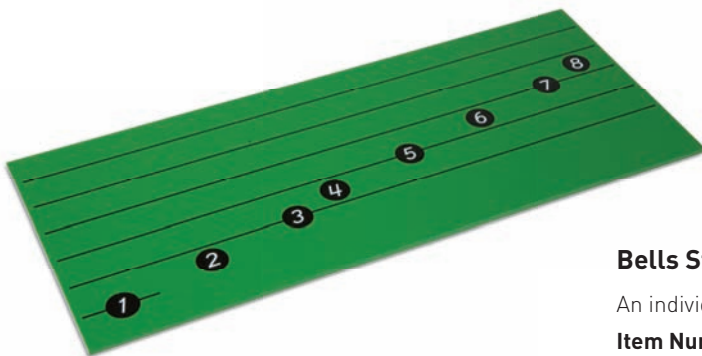
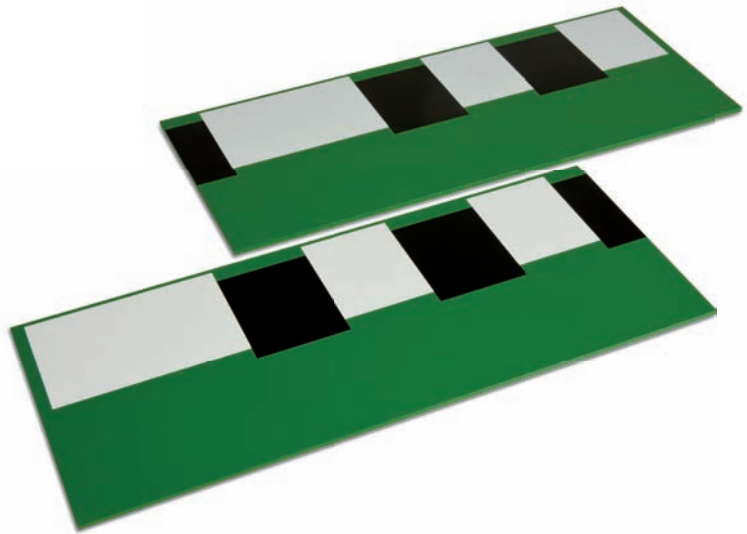

## Bells Staff Board

An individual staff board for the first exercises of notation.

**Item Number: 0.063.C0**

## Bells Staff Boards Set

A set of a staff boards for the further exercises of notation.

**Item Number: 0.063.D0**

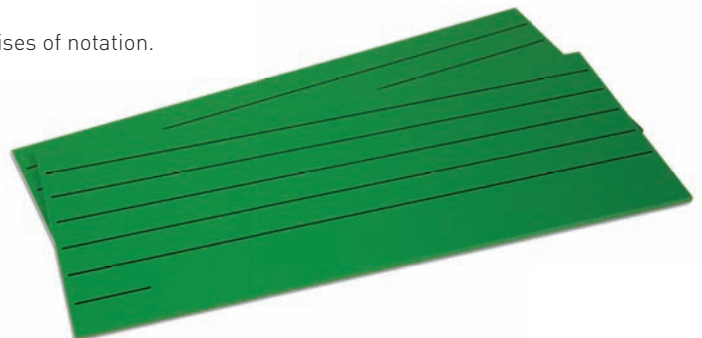

### Bells Music Signs And Notes

Material used for exercises in notation and composition. Supplied in 8 plastic boxes.

**Item Number: 0.063.E1**



### Bells Music Strip Boards

16 boards used for exercises in reading and playing groups of notes.

**Item Number: 0.064.00**

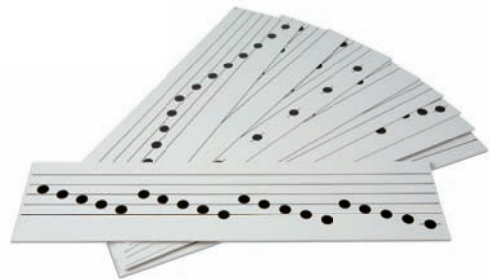

### Bell Cabinet

This cabinet is adjustable in height and is used for working with both The Bells And The Tone Bars. The dimensions are 145 x 58.5/68 x 40 cm.

**Item Number: 1.910.00**



**Tone Bars Set With Two Mallets**

The 25 tone bars in this set produce the sounds of two octaves of the key of "c" major plus the sharps and flats. (Tone Bar Keyboards not included.)

**Item Number: 0.100.A0**

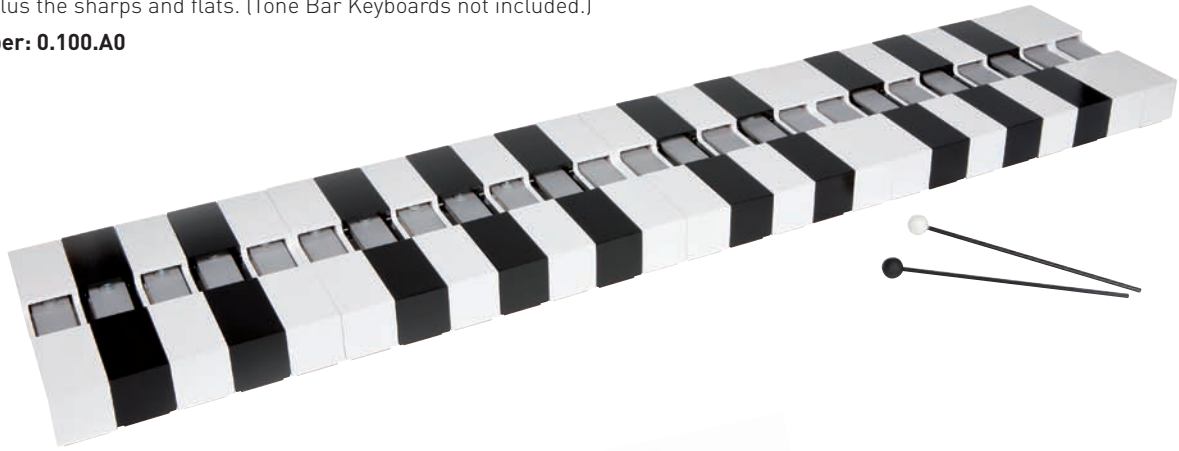

**Tone Bar Keyboards**

2 color-coded keyboards upon which to arrange the Tone Bars.

**Item Number: 0.100.A1**



**Tone Bar Mallet: Hard**

**Item Number: 0.100.A2**



**Tone Bar Mallet: Soft**

**Item Number: 0.100.A3**



**Tone Bar Cabinet**

This cabinet is adjustable in height and is used for working with both The Bells And The Tone Bars. The dimensions are 145 x 58.5/68 x 40 cm.

**Item Number: 1.910.00**

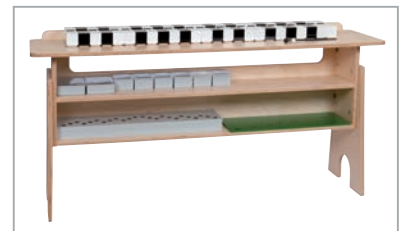

### Carpets

The children use carpets to define their work area.  
The carpets measure 66 x 120 cm with bound edges.

**Item Number: 1.640.00 - Burgundy Carpet**

**Item Number: 1.641.00 - Dark Blue Carpet**

**Item Number: 1.642.00 - Light Blue Carpet**

**Item Number: 1.643.00 - Black Carpet**

**Item Number: 1.644.00 - Beige Carpet**

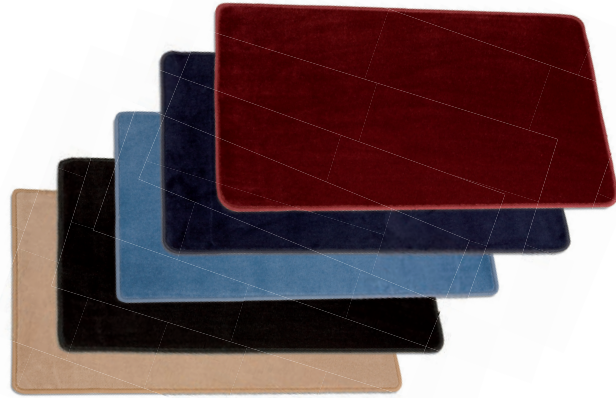

### Stand For 3 Carpets

This durable beech plywood stand stores the carpets neatly and makes them easily accessible to the child. 57 x 62 x 23 cm.

**Item Number: 1.731.00**



### Stand For 5 Carpets

This durable beech plywood stand stores the carpets neatly and makes them easily accessible to the child. 89 x 62 x 23 cm.

**Item Number: 1.732.00**



## Sensorial Cabinet (101 cm)

A cabinet designed to store and/or display the sensorial materials. The dimensions are 138 x 101 x 46 cm, which is suitable for children from 3 to 12 years of age.

**Item Number: 1.855.00**







# Language

Visitors came from all over the world to see Maria Montessori's "miracle children," the children in her first Casa dei Bambini in Rome. The children of illiterate families had begun to write and to read spontaneously after working with very simple materials: the Sandpaper Letters - that gave them the shape of the letters; the Movable Alphabet - that allowed them to arrange these letters to form words; and the Metal Insets - that made it possible for the children to control a writing instrument... thus, the importance of the Montessori Language Materials.

The Language Materials have some inherent elements in common with the Sensorial Materials. Mostly it is their simplicity and the fact that they provide keys for the children to discover something that is beyond what lies on the surface. When children first come to the Montessori environment, usually around three years of age, their spoken language is developed, their vocabulary is quite extensive and their grammatical structures of speech are well established. They have a boundless capacity to expand and enrich their language and, as a natural consequence, the desire to write and read.

The educator, who is aware of language as a vital human expression, knows that language is not something taught by another, but something created by the children themselves. It is the educator's task to facilitate the process of creation by providing rich, precise and abundant language for the children. The Montessori Language Materials become significant for the child because their function is to isolate certain universal elements, common to all languages. The children learn, for example, that all words are composed of sounds that can be made visible with written signs; in all languages, different words have different functions and sentences have structures that make the action the nucleus of the sentence.

There is little to be taught on the part of the educator, yet there is unlimited scope for exploration on the part of the children. The Montessori Language Materials provide the keys to the fascinating world of language and are highly effective in their simplicity.

### The Metal Insets

Dr. Montessori analyzed the movements that are connected with writing and developed The Metal Insets for directly preparing the child for handwriting. Use of this material strengthens the three-finger grip and coordinates the necessary wrist movements. The exercises also advance proficiency in lightness of touch and evenness of pressure through drawing activities. The Metal Insets invite unlimited geometric design possibilities. Material consists of: 10 metal insets and frames.

**Item Number: 0.046.00**

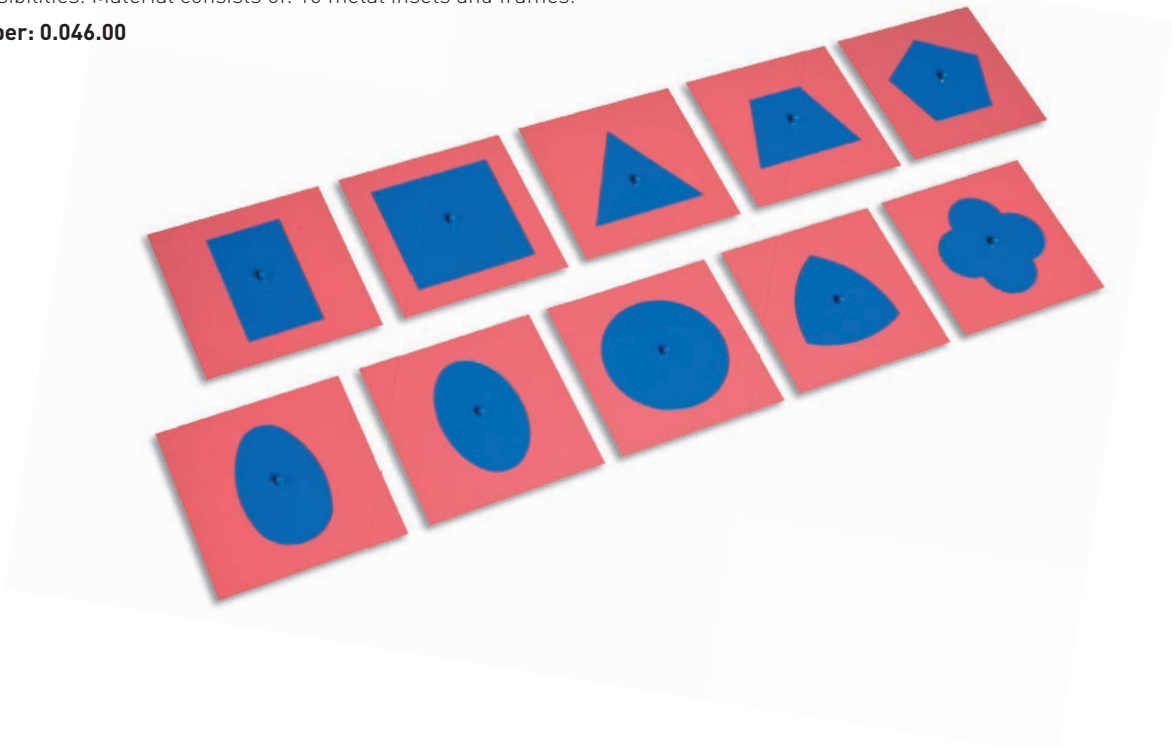

### The Metal Inset Stands

2 sloping stands: 1 for straight-sided figures and 1 for curve-sided figures.

**Item Number: 0.047.00**

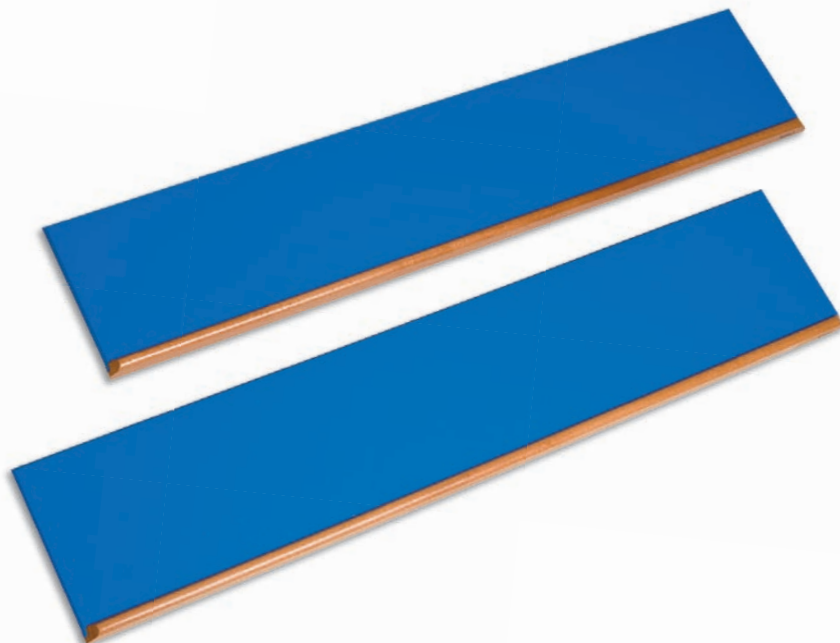

## Wall Frame For The Metal Insets

A beech plywood wall frame for holding The Metal Insets and other materials used in the exercise. 77 x 75 x 23 cm.

**Item Number: 1.730.00**





**11 Dozen Inset Pencils: 11 Colors**  
Item Number: 7.201.00

**Colored Inset Pencil Holders: Set Of 11**  
Item Number: 7.305.00



**Natural Wood Pencil Holder**  
Item Number: 7.317.00

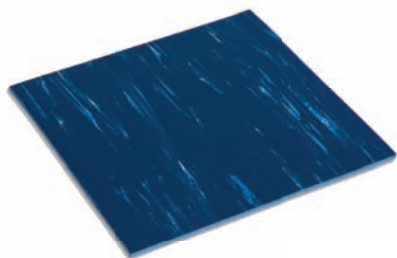

**Rubber Desk Top Pad: 14 x 14 cm**  
Item Number: 9.157.00



**Holder For 3 Pencils**  
Item Number: 7.304.00



**Paper Box: 14 x 14 cm**  
Item Number: 7.023.00



**Inset Paper: (3000)**  
Item Number: 5.679.00

## Heutink Goldline: Lead Pencils (12)

Lead pencils with medium lead hardness. Sold in boxes of 12.

Item Number: 061.065



## 3-Sided Lead Pencils: (72)

Lead pencils that match our 3-Sided Inset pencils. The 3-Sided pencil is more comfortable in the hand and aids in teaching the children the correct way to hold a pencil. Sold in a box of 72.

Item Number: 061.240



## Pencil Sharpener: For 3-Sided Pencils - Small

Item Number: 025.214



## Pencil Sharpener: For All Pencil Types - Table Model

Item Number: 035.055



## Pencil Sharpener: For All Pencil Types – Electric

Item Number: 035.063

### Detective Adjective Exercise

This exercise demonstrates the function of the adjective as the describing word. The set contains the 7 different types of triangles, each in 3 colors and each in 3 sizes (63 triangles total) in a beechwood box with lid.

**Item Number: 0.045.A0**

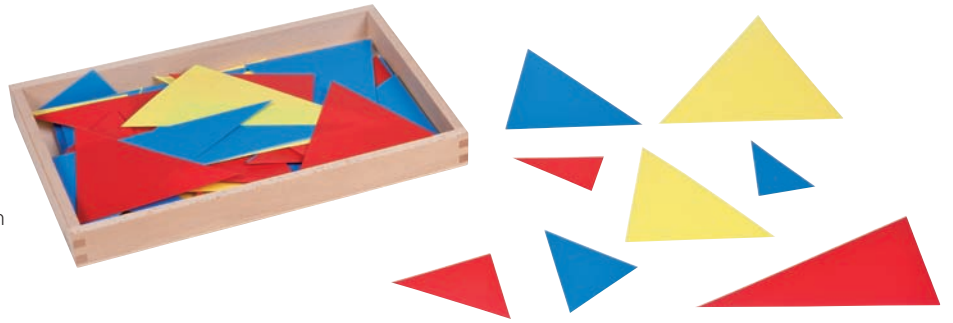

### Detective Adjective Exercise Commands

64 phrases on cards.

**Item Number: 5.612.00**

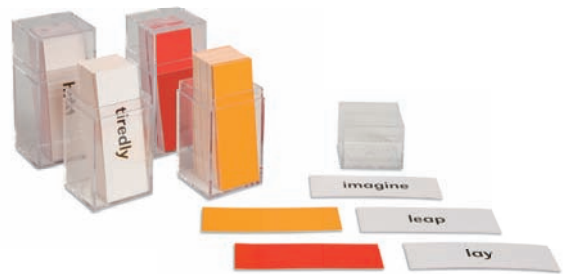

### Logical Adverb Exercise

Over 100 adverbs and verbs included in the set. Some adverbs are logical with some verbs and illogical with other verbs. Back of cards are color coded orange (adverb) and red (verb).

**Item Number: 5.642.00**

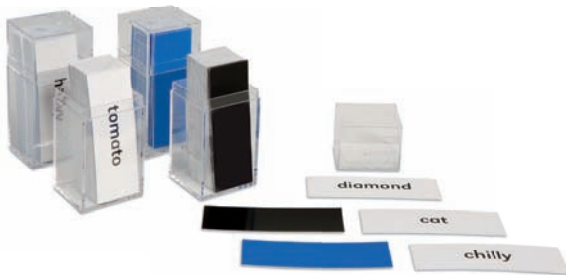

### Logical Adjective Exercise

Over 100 adjectives and nouns included. Some adjectives are logical with some nouns and illogical with other nouns. Back of cards are color coded blue (adjective) and black (noun).

**Item Number: 5.641.00**

### Grammar Exercises

For exercises using the article, adjective, conjunction and preposition. 127 cards.

**Item Number: 5.655.00**

the orange flower	the small basket	and
the red can	the plastic box	the
the pink flower	the purple button	a
the brown vase	the white pencil	the flag



## Positive, Comparative, Superlative

32 sets of adjectives - 96 words in total. Includes ordinal and cardinal names for 1 to 10. Supplied in a plastic box.

**Item Number: 5.659.00**



## Conjunction And Prepositions

120 prepositions used for introductory exercises. The only conjunction provided is the word "and". The cards have a comma on the reverse side for appropriate conjunction exercises.

**Item Number: 5.656.00**



## Singular And Plural Noun Exercises

A set of 9 reading and control sample cards list over 128 nouns that are pluralized by adding s, es, ies or ves. The individual noun and ending cards are printed so that an ending card can be placed next to the noun to make it plural.

**Item Number: 5.643.00**



## Simple Commands: Set 1

60 1-word verb commands printed in black on red cards. 90 1-word verb commands printed in red on white cards.

**Item Number: 5.653.00**



## Simple Commands: Set 2

140 simple sentence cards printed on white card stock showing actions the child can perform.

**Item Number: 5.654.00**





### The Farm

The Farm is used as a language resource in the Montessori classroom. It provides a setting for activities of language enrichment, grammar and reading. Included is: a farmhouse, people, animals, fences and a working base.

**Item Number: 0.249.00**



### The Farm Table

This specially designed beech plywood stand with a storage shelf serves as support for The Farm. Measures 76 x 60 x 45 cm.

**Item Number: 1.725.00**

### Noun Labels For The Farm

83 word labels.

**Item Number: 5.657.00**

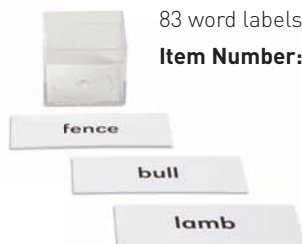

### Unprinted Cards For The Farm

**Item Number: 0.249.A0**



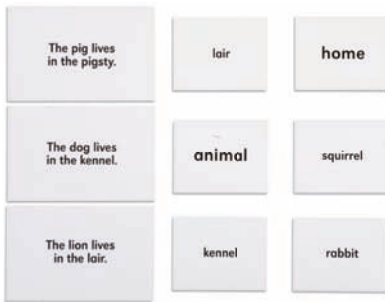

## Animals And Their Homes

41 different wild and domestic animals printed on white card stock. 82 cards naming animal and home and 41 control cards. Title cards included.

**Item Number: 5.620.00**

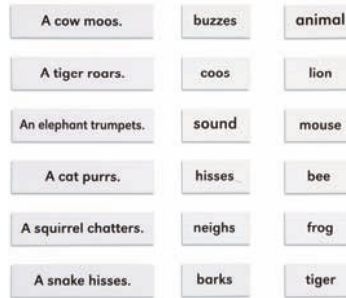

## Animals And Their Sounds

22 different domestic and 18 wild animals printed on white card stock. 80 cards naming animal and sound and 40 control cards. Title cards included.

**Item Number: 5.621.00**



## Animals And Their Young

29 wild and domestic animals and their young printed on white card stock. 58 cards naming animal and young and 29 control cards. Title cards included.

**Item Number: 5.622.00**

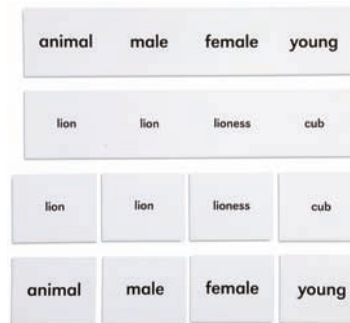

## Animal Names

27 different wild and domestic animal names printed on white card stock. 112 cards naming the male, female and young and 27 control cards. Title cards included.

**Item Number: 5.623.00**



## Animals And Their Groups

38 different wild and domestic animals printed on white card stock. 76 cards naming animal and group and 38 control cards. Title cards included.

**Item Number: 5.624.00**



## Adjective Labels For The Farm

128 article-adjective-noun phrases on labels.

**Item Number: 5.658.00**

## Sandpaper Letters

The Sandpaper Letters guide the hand for writing as the child traces the letter shapes in the style and direction that they are written. Each Sandpaper Letter is in lower case with the consonants on boards painted pink and the vowels on boards painted blue. Each board has a space on the left and right for the child to steady it with one hand while tracing the letter with the other.



**Sandpaper Letters: Cursive**

Item Number: 0.054.B4



**Sandpaper Letters: Print**

Item Number: 0.054.B3

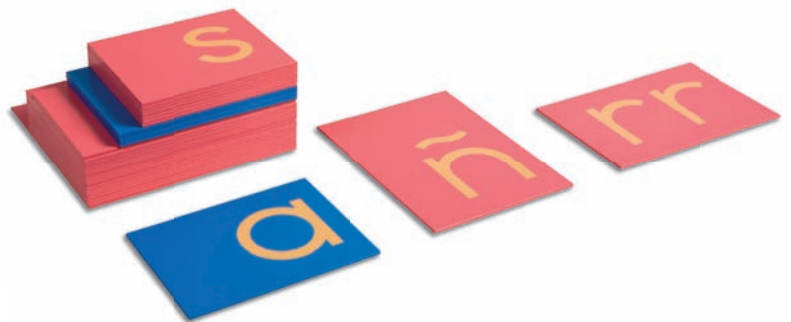

**Sandpaper Letters: Spanish, Print**

Item Number: 0.054.B9



**Sandpaper Letters Box**

Item Number: 0.057.A0

## Sandpaper Capitals

A complete upper case alphabet of Sandpaper Letters used for teaching the capital letters. The Sandpaper Capital letters are on boards painted pink and blue.

### Sandpaper Capitals: Print

Item Number: 0.057.B3

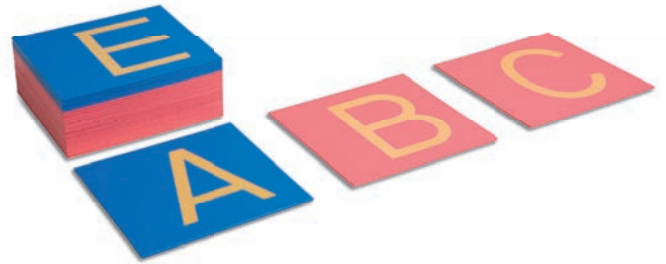

### Sandpaper Capitals: Cursive

Item Number: 0.057.B4



### Sandpaper Letters Box

Item Number: 0.057.A0



### Sandpaper Letter Tracing Tray

Item Number: 0.408.00



## Double Sandpaper Letters

The 'phonograms' introduce the non-phonetic aspects of English. The Double Sandpaper Letters form the first stage of the Complete Reading Scheme (0.055.00). Included in the set of 16 double letter combinations are: er, ee, ar, ou, oo, ai, or, ue, ie, au, oa, sh, ch, oy, th, qu. The Double Sandpaper Letters are on boards painted green.

### Double Sandpaper Letters: Print

Item Number: 0.056.B3

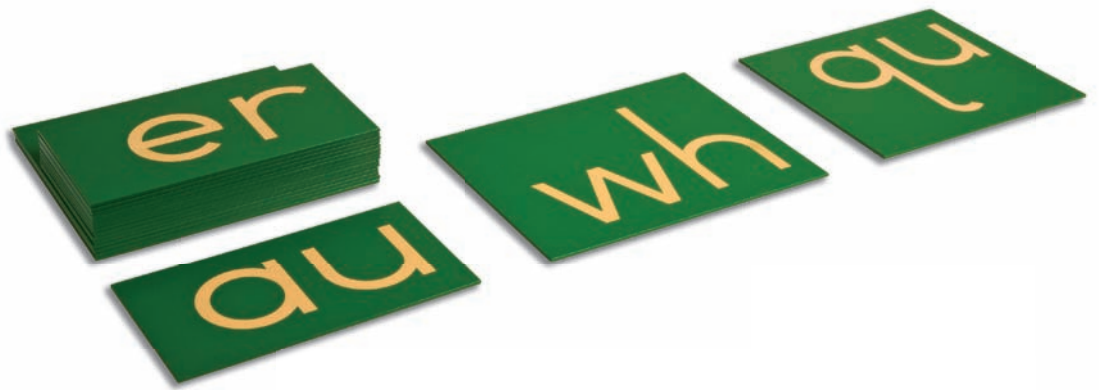

### Double Sandpaper Letters: Cursive

Item Number: 0.056.B4

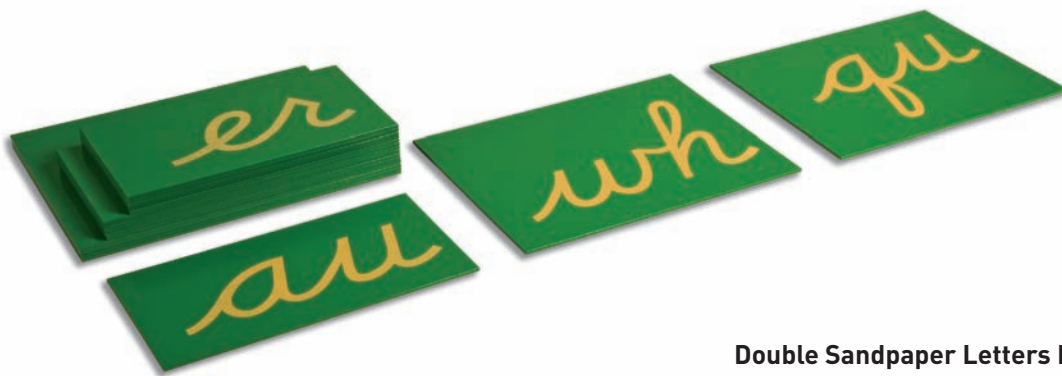

### Double Sandpaper Letters Box

Item Number: 0.056.A0



## Phonogram Cards

A set of 64 cards for the basic phonogram sounds and spelling variations. All sounds in the words are phonetic except for the isolated difficulty. There is no more than 1 difficulty in a word. All but 6 cards have 8 words and a picture that identifies the sound. Phonogram sound printed in red in the first word of each card.

**Item Number: 5.638.00**



## Phonogram Booklets

A complete set of 45 booklets, 9 pages each. Each book presents a basic phonogram sound with 8 words (1 on each page) showing spelling variations. The isolated sound on each card is printed in red. Each booklet is spiral bound.

**Item Number: 5.637.00**

## 'A Key To Writing And Reading For English'

A 26-page pamphlet, describing the reading scheme for English.

**Item Number: 0.055.50**

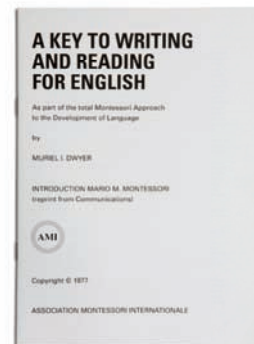

## Reading Scheme For English

This set of reading materials is a systematic approach to understanding the inconsistencies in English. It allows the child to key different letter combinations to the 16 Double Sandpaper Letters. The set of reading materials contains 13 reading folders, 25 puzzle words, and 3 phonogram dictionaries. Included is the pamphlet 'A Key To Writing And Reading English'. [Double Sandpaper Letters must be ordered separately 0.056.B3 or 0.056.B4].

**Item Number: 0.055.00**

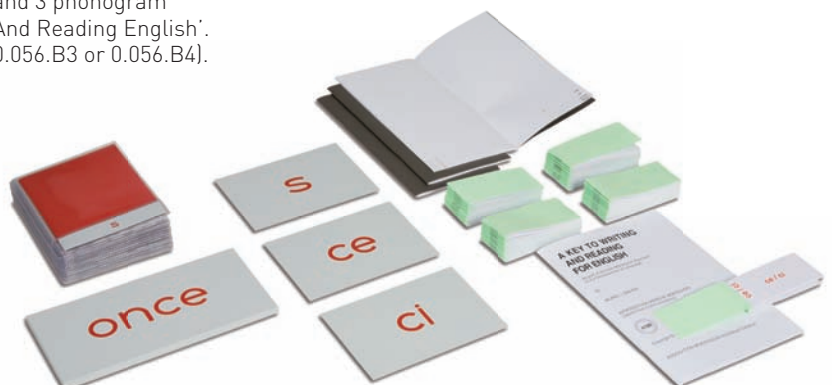

### Phonetic Reading Cards

85 cards printed with red consonants and blue vowels for beginning phonetic reading. One phonetic word isolated on each card.

**Item Number: 5.635.00**



### Phonetic Flash Cards

Phonetic words in large letters with red consonants and blue vowels printed on white card stock. 80 different words with 3 to 7 letters.

**Item Number: 5.633.00**

### Puzzle Words

126 cards printed on white card stock. These sight words do not follow the normal rules so must be memorized.

**Item Number: 5.648.00**



### Phonetic Pictures And Labels

160 cards with a single object pictured on each card. Includes matching labels. Printed in black on white card stock.

**Item Number: 5.634.00**

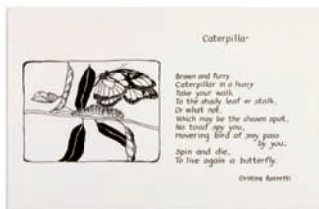

### Illustrated Poems

12 different poems.

**Item Number: 5.651.00**



### Easy Reading Booklets

A set of 18 booklets.

**Item Number: 5.650.00**

### First Books

A graded series of beginning books with isolated pictures and words.

**Item Number: 5.649.10**





**Individual Reading Material**

A material, ideal for reading practice, containing 100 wooden cards with colorful illustrations of simple objects with labels to read and match. The material is designed to be self-correcting, allowing for independent work. A beechwood tray and 2 stands are included.

**Item Number: 3.015.01**



## Large Movable Alphabet

After learning the letter sounds with the Sandpaper Letters, the Large Movable Alphabet is used by the children for the writing of words. The set of thick plastic letters contains 10 of each consonant in pink and 15 of each vowel in blue.

### Large Movable Alphabet: Print

Item Number: 0.059.A3



### Large Movable Alphabet: Cursive

Item Number: 0.059.A4



### Large Movable Alphabet Box: Print

A wooden box with lid specially crafted to contain each of the Large Movable Alphabet letters in separate compartments (Letters not included).

Item Number: 0.059.C3



### Large Movable Alphabet Box: Cursive

A wooden box with lid specially crafted to contain each of the Large Movable Alphabet letters in separate compartments (Letters not included).

Item Number: 0.059.C1

**Wooden Movable Alphabet: Print**

Wooden letters sized the same as The Sandpaper Letters.

Item Number: 0.062.00

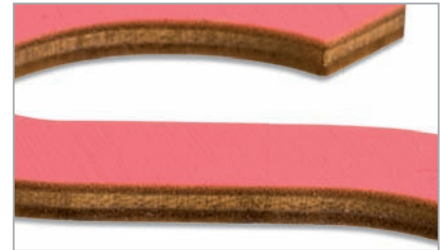

**Wooden Movable Alphabet Box: Print**

Item Number: 0.062.C0

## Medium Movable Alphabet

The Medium Movable Alphabet allows the child to build many words in a limited space. The set of thick plastic letters includes 15 of each letter.

### Medium Movable Alphabet: Print, Blue

Item Number: 0.060.R5

abcdefghijklm  
nopqrstuvwxyz

### Medium Movable Alphabet: Print, Red

Item Number: 0.060.R3

abcdefghijklm  
nopqrstuvwxyz

### Medium Movable Alphabet: Cursive, Blue

Item Number: 0.060.P5

abcdefghijklmn  
opqrstuvwxyz

### Medium Movable Alphabet: Cursive, Red

Item Number: 0.060.P3

abcdefghijklmn  
opqrstuvwxyz



**Medium Movable Alphabet Box**

A wooden box with lid specially crafted to contain each of the Medium Movable Alphabet letters in alphabetical order (Letters not included).

**Item Number: 0.060.C0**

**Spanish Medium Movable Alphabet Box**

A wooden box with lid specially crafted to contain each of the Spanish Medium Alphabet letters in separate compartments (Letters not included).

**Item Number: 0.060.C9**



**Medium Movable Alphabet: Spanish, Print**

**Item Number: 0.060.R9**

## Small Movable Alphabet

The Small Movable Alphabet is ideal for phonogram word building in 2 colors. Phonogram word building is presented with black letters, and a second box of red or blue letters. The words are built with black letters and the phonogram is highlighted in red or blue letters.

**Small Movable Alphabet: Print, Black**  
Item Number: 0.060.A7

abcdefghijklmnopqrstuvwxyz  
nopqrstuvwxyz

abcdefghijklmnopqrstuvwxyz  
nopqrstuvwxyz

**Small Movable Alphabet: Print, Blue**  
Item Number: 0.060.A5

**Small Movable Alphabet: Print, Red**  
Item Number: 0.060.A3

abcdefghijklmnopqrstuvwxyz  
nopqrstuvwxyz



**Small Movable Alphabet Box**  
(Letters not included).  
Item Number: 0.060.C2

## Printed Alphabet

The Printed Alphabet is used for writing words, sentences and creative story writing. There are 24 of each plastic letter - printed in lower case on one side and upper case on the other side.

### Printed Alphabet: Print, Red

Item Number: 0.061.T2



### Printed Alphabet: Print, Blue

Item Number: 0.061.T0



### Printed Alphabet: Cursive, Red

Item Number: 0.061.P2



### Printed Alphabet: Cursive, Blue

Item Number: 0.061.P0



### Printed Alphabet Box: Cursive

Wooden box and lid with 33 slanted compartments for storing letters (Letters not included).

Item Number: 0.061.C0



### Printed Alphabet Box: Print

Wooden box and lid with 33 slanted compartments for storing letters (Letters not included).

Item Number: 0.061.C1

## Greenboards

Chalkboards are painted with special green chalkboard paint for ease of writing (32 x 50 cm).

### Greenboards Blank: Set Of 2 Item Number: 0.066.00



### Greenboards With Lines And Squares: Set Of 2

One side ruled in squares and the other ruled in horizontal lines for practice in writing numbers and letters.

Item Number: 0.067.00

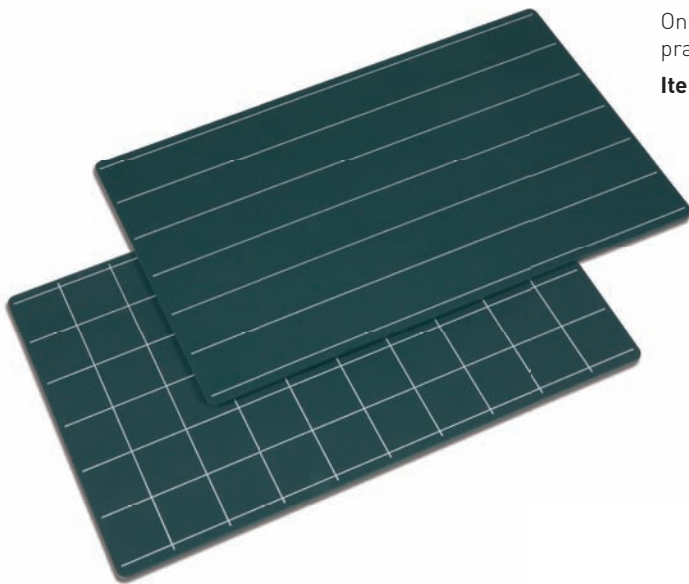

### Greenboards With Double Lines And Squares: Set Of 2

One side ruled to guide the child in placement of ascending and descending letters and the other is ruled in squares.

Item Number: 0.068.00

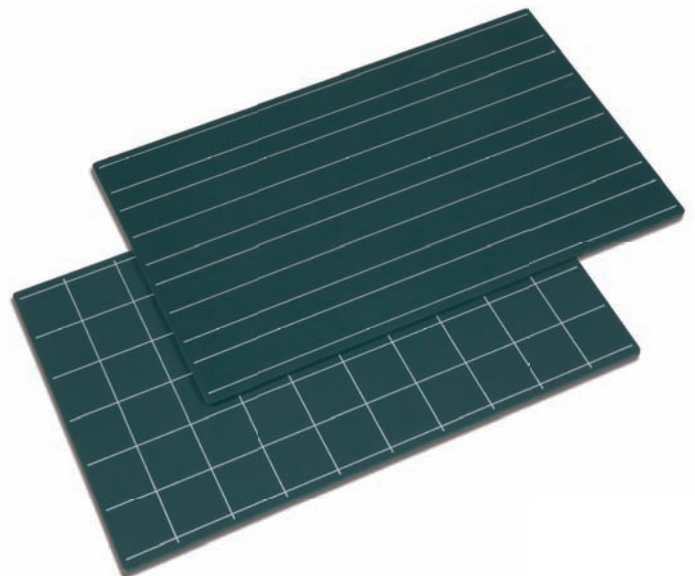



### Stand For Greenboards

Stand holds 10 boards with a top shelf for storing chalk, erasers and paper. 34 x 62 x 37 cm.

**Item Number: 1.735.00**

### Wooden Boards: Set Of 2

These boards are to guide the child in the correct placement of the large and medium sized moveable alphabet letters. One side is ruled for the large moveable alphabet and the other side is ruled for the medium moveable alphabet.

**Item Number: 0.058.00**



### Small Blackboard Eraser

**Item Number: 7.405.00**



### Plastic Grammar Symbols In Box

The grammar symbols help to sensorially reinforce each part of speech. There are 15 different symbols, each representing a specific part of speech. The symbols are made from heavy plastic and are stored in a wooden box with lid.

**Item Number: 0.110.00**



### Paper Grammar Symbols In Box

Same as above, except the symbols are made of glossy colored paper.

**Item Number: 0.112.50**



### Template For Grammar Symbols

After the introduction of the grammar symbols this template is to be used with writing exercises. Template measures 4 x 13.2 cm.

**Item Number: 0.111.60**

### Paper Grammar Symbols Replacement Set

100 each of the 15 different symbols made from glossy colored paper.

**Item Number: 0.111.00**



### Grammar Symbols Box: 10 Compartments

An empty box with 10 compartments used in the primary class where no advanced symbols are required. Contents are ordered separately.

**Item Number: 0.112.A0**



### Grammar Symbols Box: 15 Compartments

An empty box with 15 compartments used for storing the 15 individual grammar symbols. Contents are ordered separately.

**Item Number: 0.112.00**

## Individual Grammar Symbols

### Noun

Item Number: 0.110.A0 - Plastic (20)

Item Number: 0.111.A0 - Paper (100)

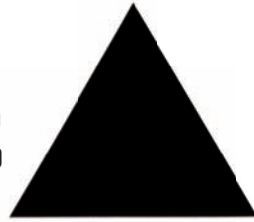

### Article

Item Number: 0.110.B0 - Plastic (10)

Item Number: 0.111.B0 - Paper (100)



### Adjective

Item Number: 0.110.C0 - Plastic (24)

Item Number: 0.111.C0 - Paper (100)



### Numeral

Item Number: 0.110.D0 - Plastic (10)

Item Number: 0.111.D0 - Paper (100)



### Verb

Item Number: 0.110.E0 - Plastic (25)

Item Number: 0.111.E0 - Paper (100)



### Preposition

Item Number: 0.110.F0 - Plastic (10)

Item Number: 0.111.F0 - Paper (100)



### Adverb

Item Number: 0.110.G0 - Plastic (10)

Item Number: 0.111.G0 - Paper (100)



### Pronoun

Item Number: 0.110.H0 - Plastic (10)

Item Number: 0.111.H0 - Paper (100)



### Conjunction

Item Number: 0.110.I0 - Plastic (25)

Item Number: 0.111.I0 - Paper (100)



### Interjection

Item Number: 0.110.J0 - Plastic (10)

Item Number: 0.111.J0 - Paper (100)



### Auxiliary

Item Number: 0.110.K0 - Plastic (10)

Item Number: 0.111.K0 - Paper (100)



### Abstract

Item Number: 0.110.L0 - Plastic (10)

Item Number: 0.111.L0 - Paper (100)



### Participle

Item Number: 0.110.M0 - Plastic (12)

Item Number: 0.111.M0 - Paper (100)



### Copula

Item Number: 0.110.N0 - Plastic (10)

Item Number: 0.111.N0 - Paper (100)



### Spiritual

Item Number: 0.110.P0 - Plastic (10)

Item Number: 0.111.P0 - Paper (100)



**3D Wooden Grammar Symbols: Set Of 10 With Tray**

A beautiful set of three-dimensional grammar symbols for the first introduction of the parts of speech. Includes 10 symbols and a beechwood tray for storage.

**Item Number: 0.106.00**



**3D Wooden Grammar Symbol: Noun**  
Item Number: 0.106.A0



**3D Wooden Grammar Symbol: Article**  
Item Number: 0.106.B0



**3D Wooden Grammar Symbol: Adjective**  
Item Number: 0.106.C0



**3D Wooden Grammar Symbol: Numeral**  
Item Number: 0.106.D0



**3D Wooden Grammar Symbol: Verb**  
Item Number: 0.106.E0



**3D Wooden Grammar Symbol: Preposition**  
Item Number: 0.106.F0



**3D Wooden Grammar Symbol: Adverb**  
Item Number: 0.106.G0

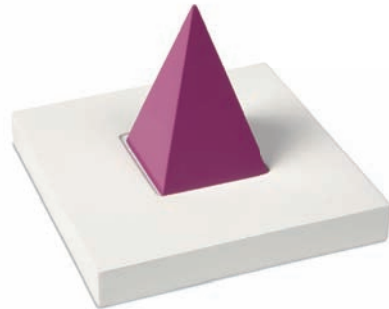

**3D Wooden Grammar Symbol: Pronoun**  
Item Number: 0.106.H0



**3D Wooden Grammar Symbol: Conjunction**  
Item Number: 0.106.I0



**3D Wooden Grammar Symbol: Interjection**  
Item Number: 0.106.J0

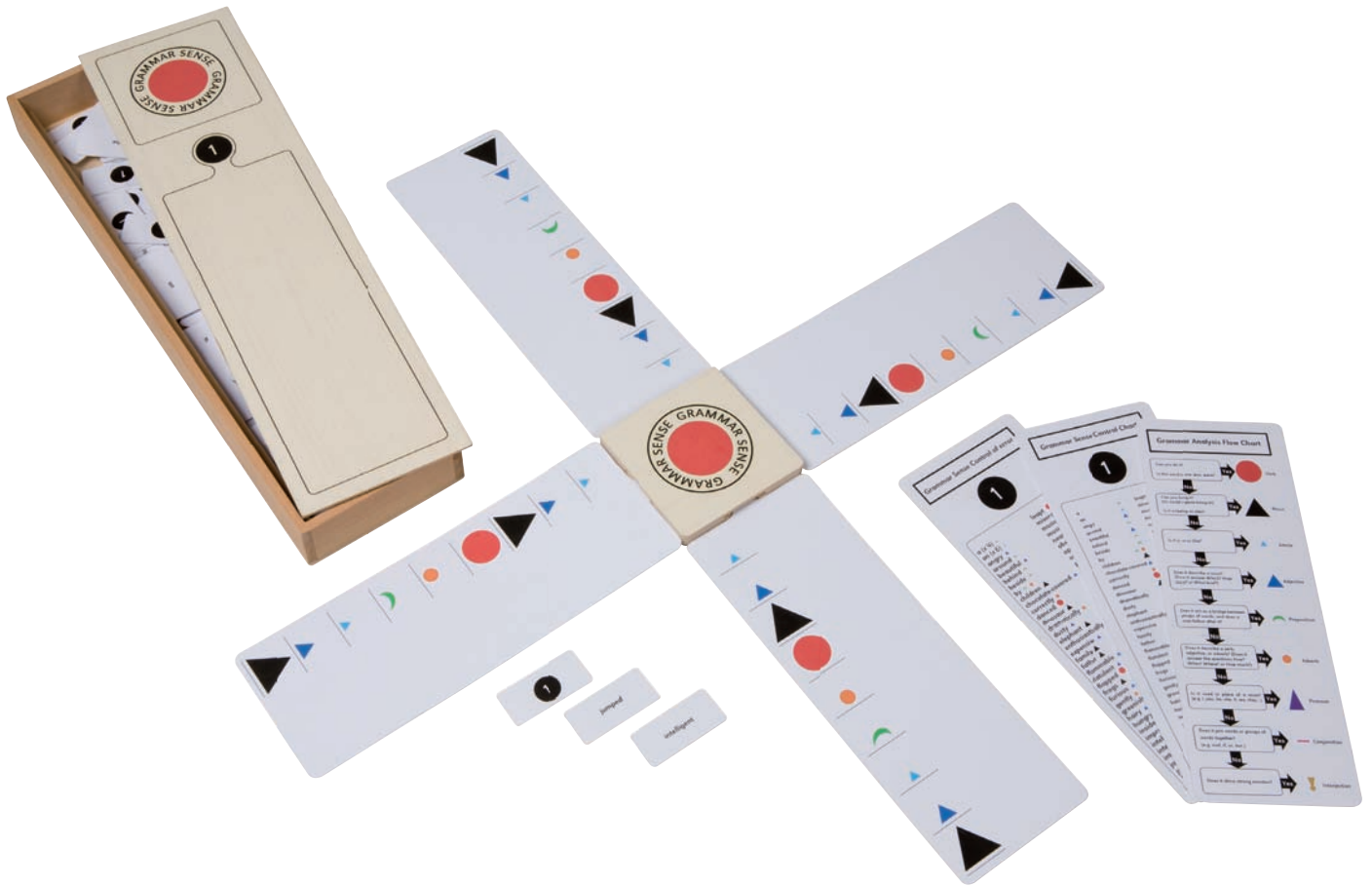

### Grammar Sense Game: Set 1

The Grammar Sense Game helps the child internalize a sense of the functions of the parts of speech. Children choose words randomly and place them into a sentence structure template based on their function. The sentences created are grammatically correct, but semantically nonsensical. It is great fun for the children. Includes: 1 base block, 4 paddle cards, 2 control charts, 1 flow chart, 84 word cards, instructions and a wooden box with lid. Designed by Mark Powell

**Item Number: 0.107.01**



## The Land Of The Parts Of Speech

A story, written in the form of a fairy tale, that helps familiarize children with the various parts of speech. It originates from a lecture given by Mario Montessori at a course at the German Montessori Association in Frankfurt, Germany in the late 1950's.

**Item Number: 0.649.01**

## Grammar Symbol Tiles

The Grammar Symbol Tiles enable a child to learn the grammar symbols in a very dynamic and physical way. Just like in a written sentence, the verb has a central role and all the other symbols are laid in a circle around it. As one child reads a sentence, another child leaps from symbol to symbol indicating the various parts of speech of the sentence. The symbols are enlarged in exactly the same proportions as the original grammar symbols.

**Item Number: 0.107.50**

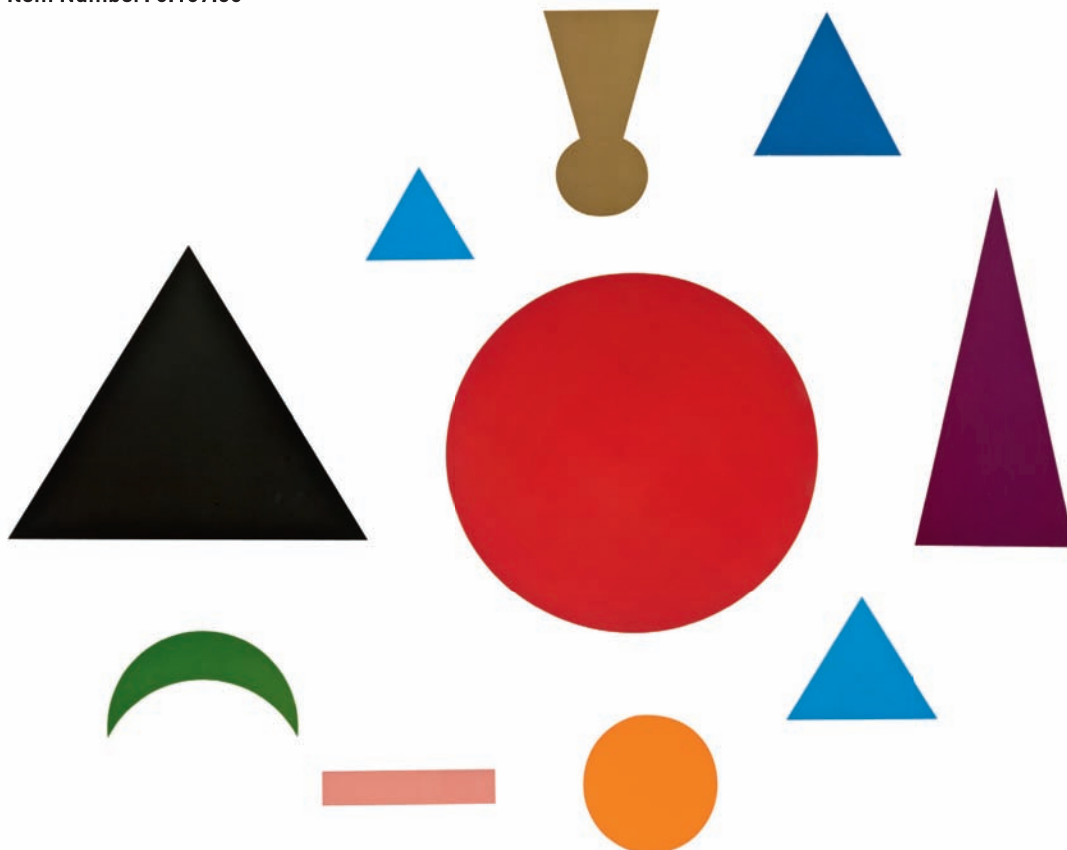

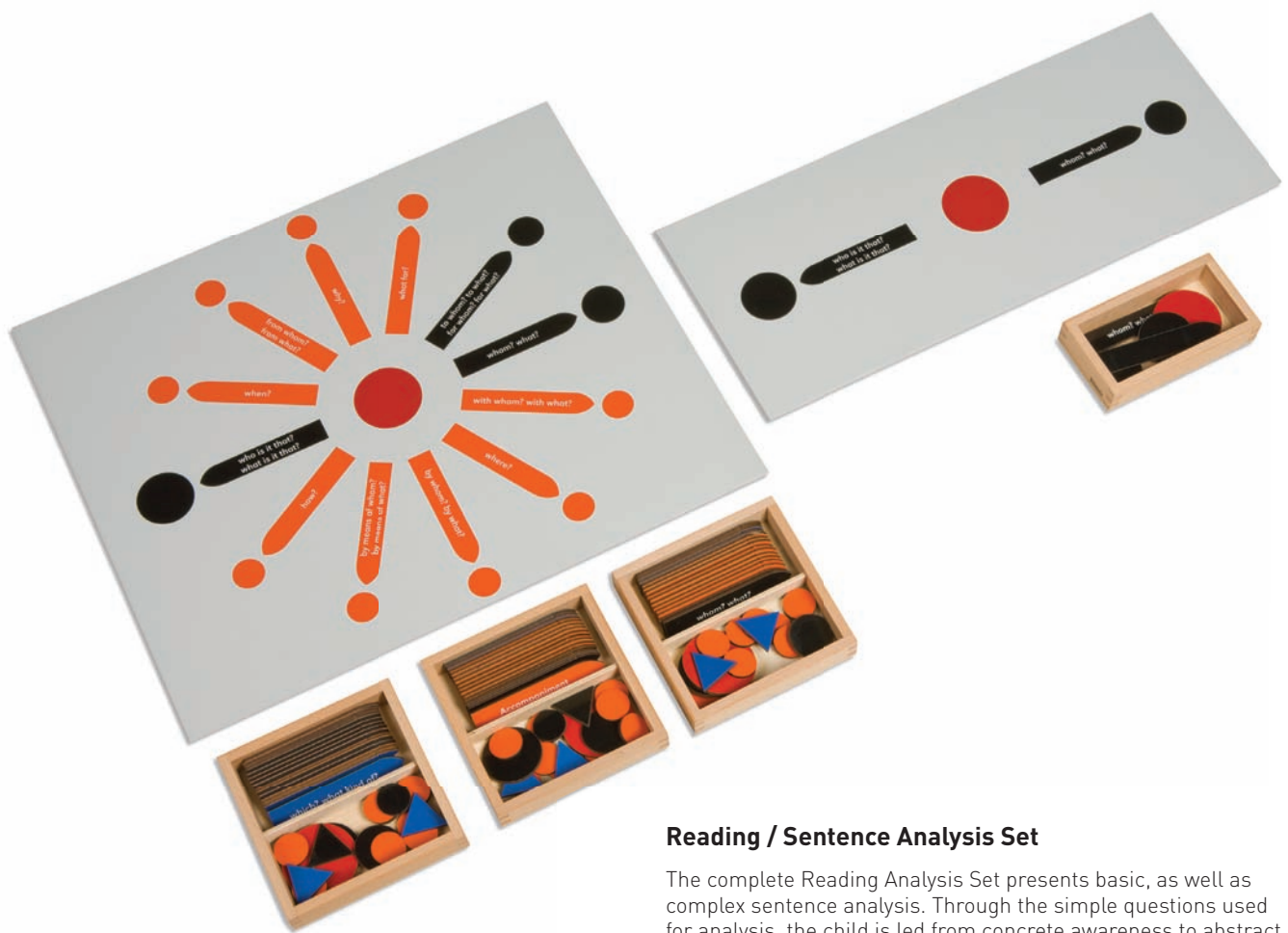

### Reading / Sentence Analysis Set

The complete Reading Analysis Set presents basic, as well as complex sentence analysis. Through the simple questions used for analysis, the child is led from concrete awareness to abstract understanding of sentence structure. The set includes: the First Chart And Box (0.108.A1) plus the advanced chart, with boxes of arrows, circles and triangles for complex sentence analysis.

**Item Number: 0.108.01**



### Template For Sentence Analysis

After the introduction of the Sentence Analysis material, this template is to be used with writing exercises. Template measures 4 x 13.2 cm.

**Item Number: 0.111.50**

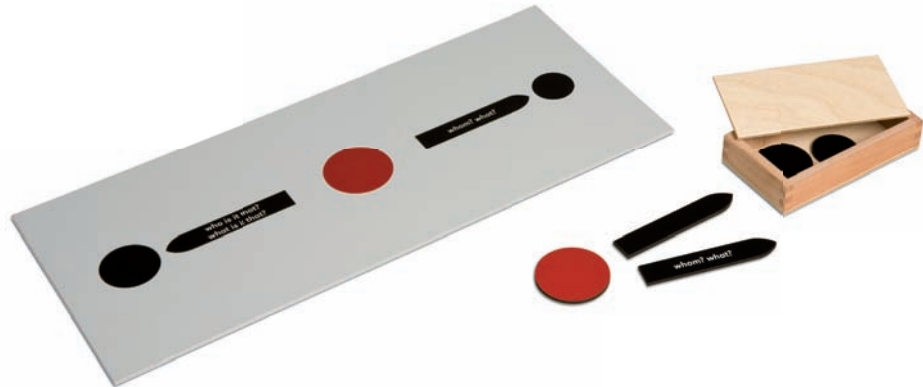

## Reading Analysis: First Chart And Box

This material helps the child to analyze the basic parts of a sentence and identify its function. The first chart and box introduces the predicate, subject and direct object. The set includes a chart and a wooden box containing circles and arrows with the printed questions for beginning analysis.

**Item Number: 0.108.A1**



## Sentence Analysis Working Chart

The control chart helps the child correct their own work and also links the simple questions asked by the exercises with the nomenclature of grammar.

**Item Number: 0.108.B1**

## Set Of Arrows And Circles For Sentence Analysis

A set of unprinted arrows and circles, to be used for initial sentence analysis exercises.

**Item Number: 0.108.C0**





## Grammar Material

In the Montessori classroom, the 'Grammar Box Material' is comprised of the following component materials:

- **Grammar Boxes - Item Number: 0.102.01**
- **Grammar Filling Boxes - Item Number: 0.103.01**
- **Printed Grammar Cards - Item Number: 0.104.01**
- **Grammar Command Boxes - Item Number: 0.105.A1**



### Grammar Boxes

These activities aid the child in the analysis of grammar and development of interpretive reading. The boxes are constructed from quality hardwood and the sloping compartments are silk-screened in the color-code that highlights each part of speech.

**Item Number: 0.102.01**

## Grammar Filling Boxes

The set of 36 Filling Boxes is used to organize the grammar cards by exercise. The color of each exercise box corresponds to the coded-color for each part of speech. The set includes the following:

- 4 black boxes with tan top - article, noun
- 7 brown boxes - adjective
- 6 red boxes - verb
- 4 purple boxes - preposition
- 4 pink boxes - adverb
- 5 green boxes - pronoun
- 3 yellow boxes - conjunction
- 3 blue boxes - interjection

**Item Number: 0.103.01**





**Printed Grammar Cards**

A complete set of durable plastic Printed Grammar Cards for all the activities with the Grammar Boxes. The set includes phrase and sentence cards with accompanying grammar cards. Also included are printed command cards, their accompanying working cards and clear plastic folders for organization within the command boxes. The phrase and sentence cards and grammar cards are color-coded to correspond with the Grammar Boxes and Filling Boxes. Manual included.

**Item Number: 0.104.01**



**Unprinted Grammar Cards**

A set of blank, color-coded paper cards for teacher-created grammar cards.

**Item Number: 0.104.A0**

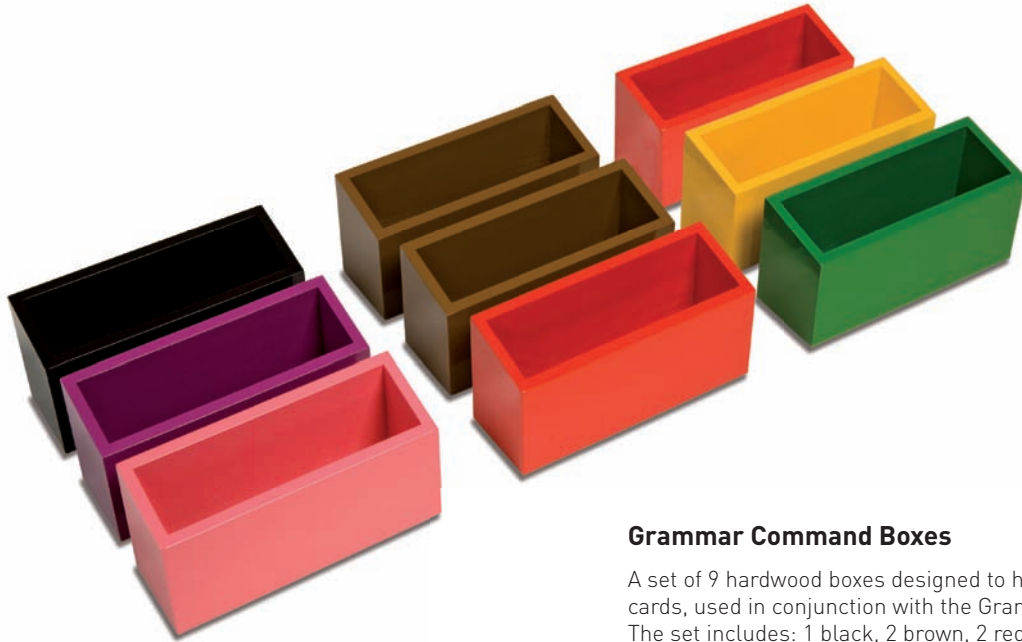

### Grammar Command Boxes

A set of 9 hardwood boxes designed to hold the command cards, used in conjunction with the Grammar Box activities. The set includes: 1 black, 2 brown, 2 red, 1 purple, 1 pink, 1 green and 1 yellow box.

**Item Number: 0.105.A1**

### Explanation Grammar Boxes

A booklet explaining how to use the Montessori grammar material.

**Item Number: 0.105.02**

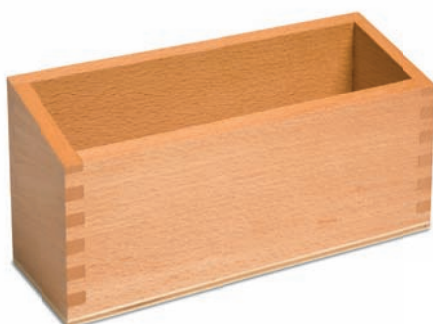
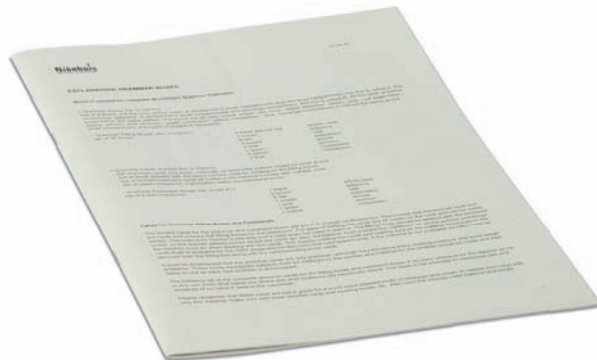

### Command Box In A Natural Finish

**Item Number: 0.105.B0**

## Writing Paper

**Writing Paper: Blue Lines - 2.75 x 7 in - (500)**

Item Number: 5.663.00



**Writing Paper: Blue Lines - 2 x 8.5 in - (500)**

Item Number: 5.660.00

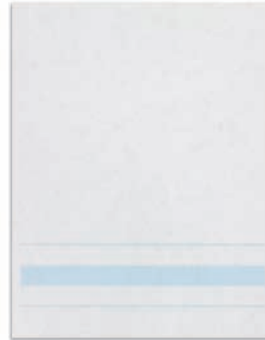

**Writing Paper: Blue Lines - 4.25 x 5.5 in - (500)**

Item Number: 5.662.00



**Writing Paper: Blue Lines - 4 x 8.5 in - (500)**

Item Number: 5.661.00

**Writing Paper: Blue Lines - 7 x 8.5 in - (500)**

Item Number: 5.664.00



**Writing Paper: Green Lines - 7 x 8.5 in - (500)**

Item Number: 5.668.00



**Writing Paper: Blue Lines - 8.5 x 11 in - (500)**

Item Number: 5.665.00



**Writing Paper: Green Lines - 8.5 x 11 in - (500)**

Item Number: 5.669.00



**Double Lined Paper: Narrow Lines (250)**  
Item Number: 0.165.B0



**Single Lined Paper: (250)**  
Item Number: 0.164.00



**Double Lined Paper: (250)**  
Item Number: 0.165.00

**Writing Booklets: Yellow - Small (100)**  
Item Number: 0.166.B0



**Writing Booklets: Yellow - Large (100)**  
Item Number: 0.166.A0

**Writing Booklets: Red - Small (100)**  
Item Number: 0.166.B1

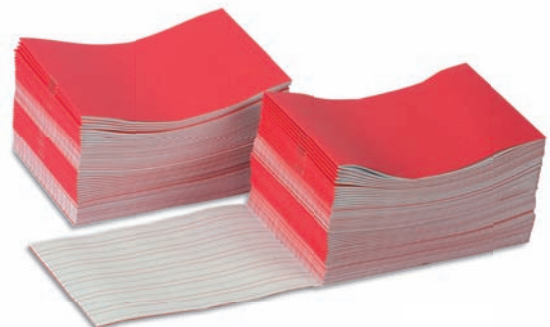

**Writing Booklets: Red - Large (100)**  
Item Number: 0.166.A1



1	2	3	4	5	6	7	8	9	10
10	20	30	40	50	60	70	80	90	100
9	18	27	36	45	54	63	72	81	90
8	16	24	32	40	48	56	64	72	80
7	14	21	28	35	42	49	56	63	70
6	12	18	24	30	36	42	48	54	60
5	10	15	20	25	30	35	40	45	50
4	8	12	16	20	24	28	32	36	40
3	6	9	12	15	18	21	24	27	30
2	4	6	8	10	12	14	16	18	20

# Mathematics

Of all the Montessori apparatus, the Math Materials are the most glamorous. They are beautiful, showy, and in their simplicity, supremely intelligent. They give children a sensorial experience of the abstraction that is mathematics, allowing them to store concepts so that when the time comes to deal exclusively in abstract terms, the understanding is already there. In a word, they are magical.

Before working with the Math Materials, the children are well prepared. The Exercises of Practical Life have given them the opportunity to develop logical and sequential thought patterns. The logical order of the Practical Life activities is complimented by the mathematical order inherent in the Sensorial Materials. These materials allow the children to work with the quantities 1 -10 in several different dimensions and then with using the Math Materials, they are given their numerical value.

The Montessori Materials offer a clear example of indirect preparation, a principle that is rooted in the child's natural manner of learning. Each piece of material isolates one concept, and these isolated concepts integrate to form the basis for a further step in the development of the child's mathematical understanding.

Another area is that of indirect preparation. In this series of exercises, the children are presented with the four operations of Math in concrete form. When performing addition, subtraction, multiplication and division, they literally carry and borrow and change the quantities involved. As they put them together and take them apart, they perceive unconsciously the interplay of the numbers, which prepares them later to explore and memorize the tables with another series of exercises that again, isolate the particularities of each operation.

Through all this, the children will consciously pursue the exploration of mathematics in a manner appropriate to the characteristics of their age. All their work done previously has prepared them to master the skills of mathematics, and in the end the child's brilliant, adventurous mind can take off to explore the untold reaches of the mathematical sciences.



### Number Rods

The Number Rods introduce the child to quantity 1-10 and their corresponding number names. Through exploration with the material, the child also develops concepts in sequence of number, combinations of 10 and basic arithmetic. The material consists of 10 wooden rods, divided into units by alternating colors of red and blue, progressing in 10 equal steps from 10 cm to 1 meter.

**Item Number: 0.027.00**

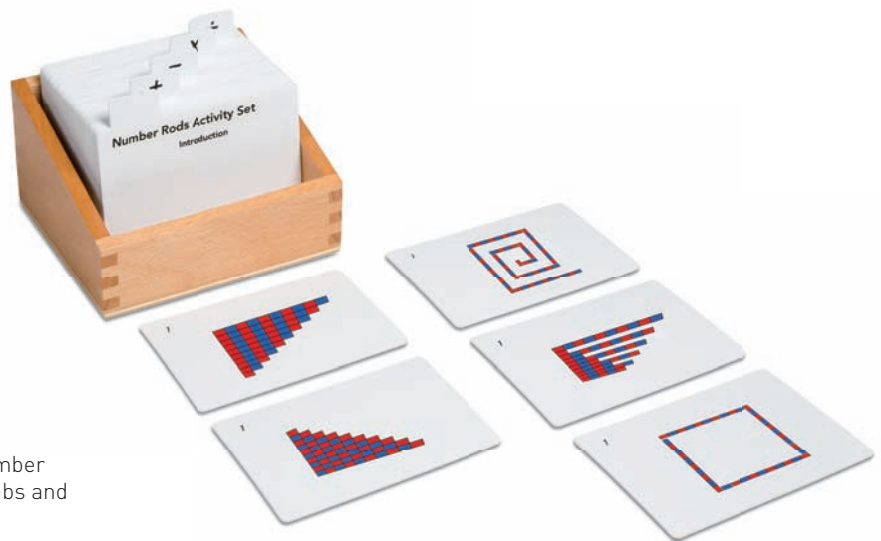
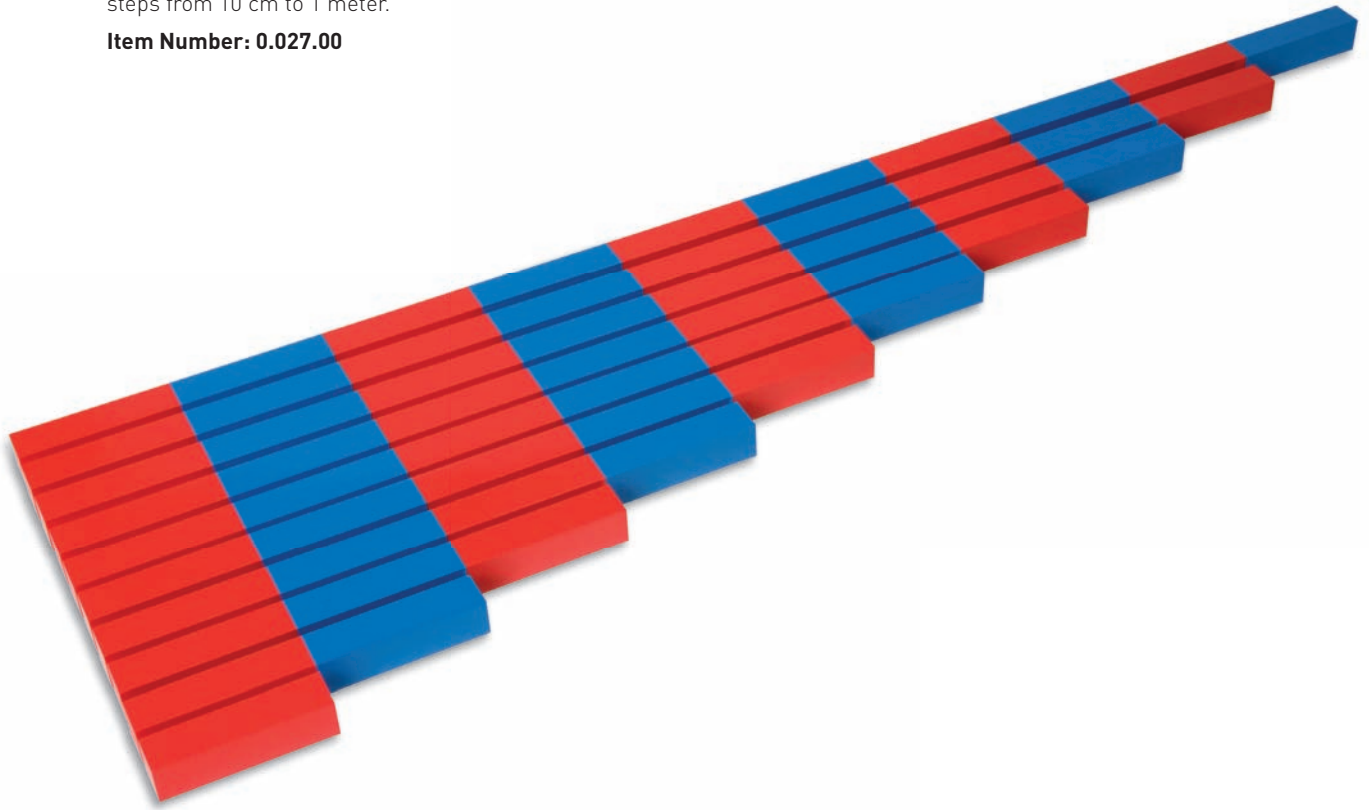

### Number Rods Activity Set

Additional exercises for use with the Number Rods. Includes: exercise cards, divider tabs and a wooden box for storage.

**Item Number: 0.628.01**

## Printed Numerals

The Printed Numerals are used with the Number Rods to associate quantity and symbol 1-10. The numerals are printed in red on wooden tablets.

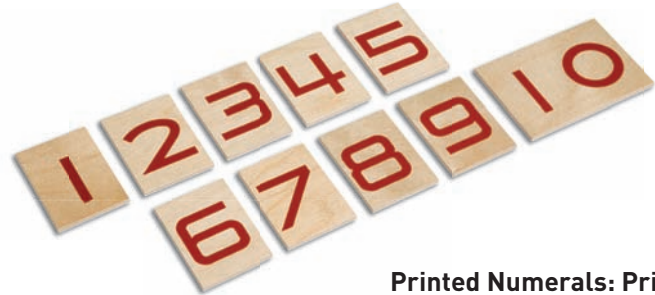

**Printed Numerals: Print**  
Item Number: 0.033.00



**Printed Numerals: Cursive**  
Item Number: 0.033.01

**Printed Numerals: USA Style Print**  
Item Number: 0.033.03



**Printed Numerals Box**  
Item Number: 0.033.A0

## Spindle Box

The Spindle Box provides practice in associating quantity and symbol for the numbers 0-9. 45 loose wooden spindles are included.



**Spindle Box: Print**  
Item Number: 0.032.00

## Spindle Box: Cursive

Item Number: 0.032.01



**Spindle Box: USA Style Print**  
Item Number: 0.032.03

## Spindles: Set Of 10 Item Number: 0.032.10



## Loose Spindles Box

(Spindles not included).  
Item Number: 0.032.B0

## Small Numerical Rods

These rods are designed for individual work at a table. Material consists of 2 sets of 10 wooden rods divided into unit increments by alternating colors of red and blue. The Small Numerical Rods are supplied in a wooden box for storage.

Item Number: 0.254.00

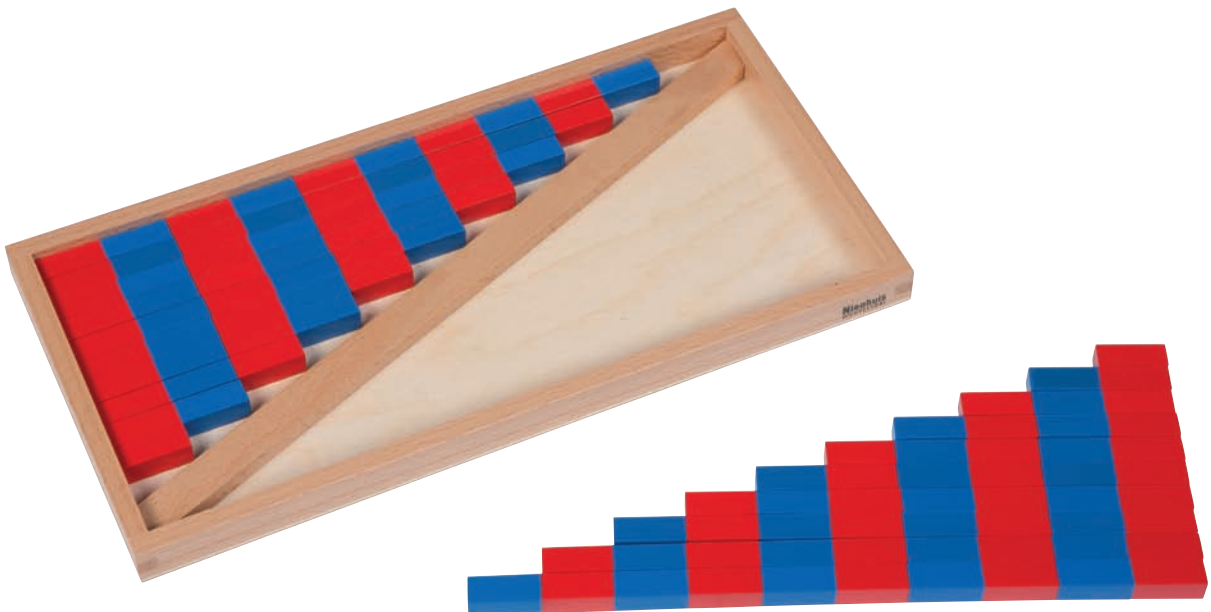

## Sandpaper Numerals

The Sandpaper Numerals introduce the child to symbol 0-9 and their corresponding number names. By tracing the numerals in the style and direction in which they are written, the child is preparing for writing numbers. The 10 rough sandpaper numerals are mounted on smooth green boards.



**Sandpaper Numerals: Print**

Item Number: 0.028.10

**Sandpaper Numerals: Cursive**

Item Number: 0.028.11



**Sandpaper Numerals: USA Style Print**

Item Number: 0.028.13

**Sandpaper Numerals Box**

Item Number: 0.028.A0



## Numerals And Signs

6 sets of wooden cut-out numerals and the signs '+' and '-' for use in addition and subtraction exercises. Includes a divided beechwood box with lid.

### Numerals And Signs: Print

Item Number: 0.027.A0



### Numerals And Signs: Cursive

Item Number: 0.027.A1



### Numerals And Signs: USA Style Print

Item Number: 0.027.A3



### Cut-Out Numerals And Counters

In the final stage of number work 1-10, the child applies his skills in associating quantity and symbol by identifying and placing the numerals in their proper sequence and then associating the corresponding amount of counters beneath them.



**Cut-Out Numerals And Counters: Print**  
Item Number: 0.036.00



**Cut-Out Numerals And Counters: Cursive**  
Item Number: 0.036.01



**Cut-Out Numerals And Counters: USA Style Print**  
Item Number: 0.036.03





## Cut-Out Numerals And Counters Activity Set

Additional exercises for use with The Cut-Out Numerals And Counters material. Includes: exercise cards, tab divider cards and a wooden box for storage.

**Item Number: 0.620.01**

### Counters Red: (100)

Item Number: 0.034.01

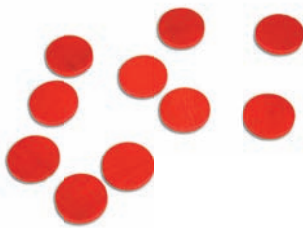

### Counters Green: (100)

Item Number: 0.034.02

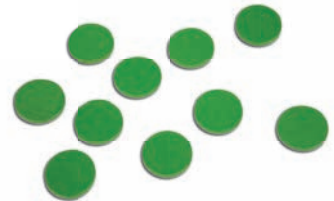

### Counters White: (100)

Item Number: 0.034.04



### Counters Blue: (100)

Item Number: 0.034.03



### Counters Yellow: (100)

Item Number: 0.034.05





### Cut-Out Numerals

These red cut-out wooden numerals are used in numerous arithmetic exercises.



**Cut-Out Numerals: Print**  
Item Number: 0.035.00

### Cut-Out Numerals: Cursive

Item Number: 0.035.01



### Cut-Out Numerals: USA Style Print

Item Number: 0.035.03

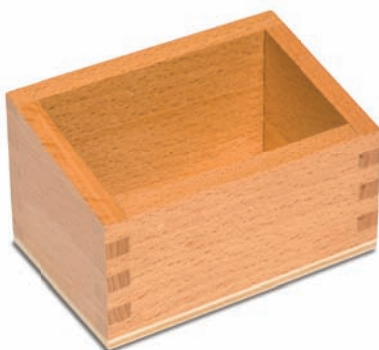
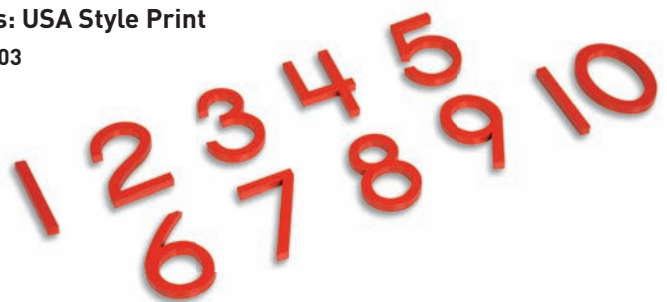

### Cut-Out Numerals Box

Item Number: 0.035.A0

## Nienhuis Individual And Connected Bead Material

Nienhuis Montessori manufactures 2 styles of Bead Material. The individual beads are available in glass or nylon and are separately strung on wire to make up 10 bars, 100 squares, and 1000 cubes. Connected nylon beads are fused together in a special process and provide a lower cost alternative to the individual beads. The individual beads demonstrate more clearly that each quantity is made up of units, and are therefore best suited for the Golden Bead exercises.

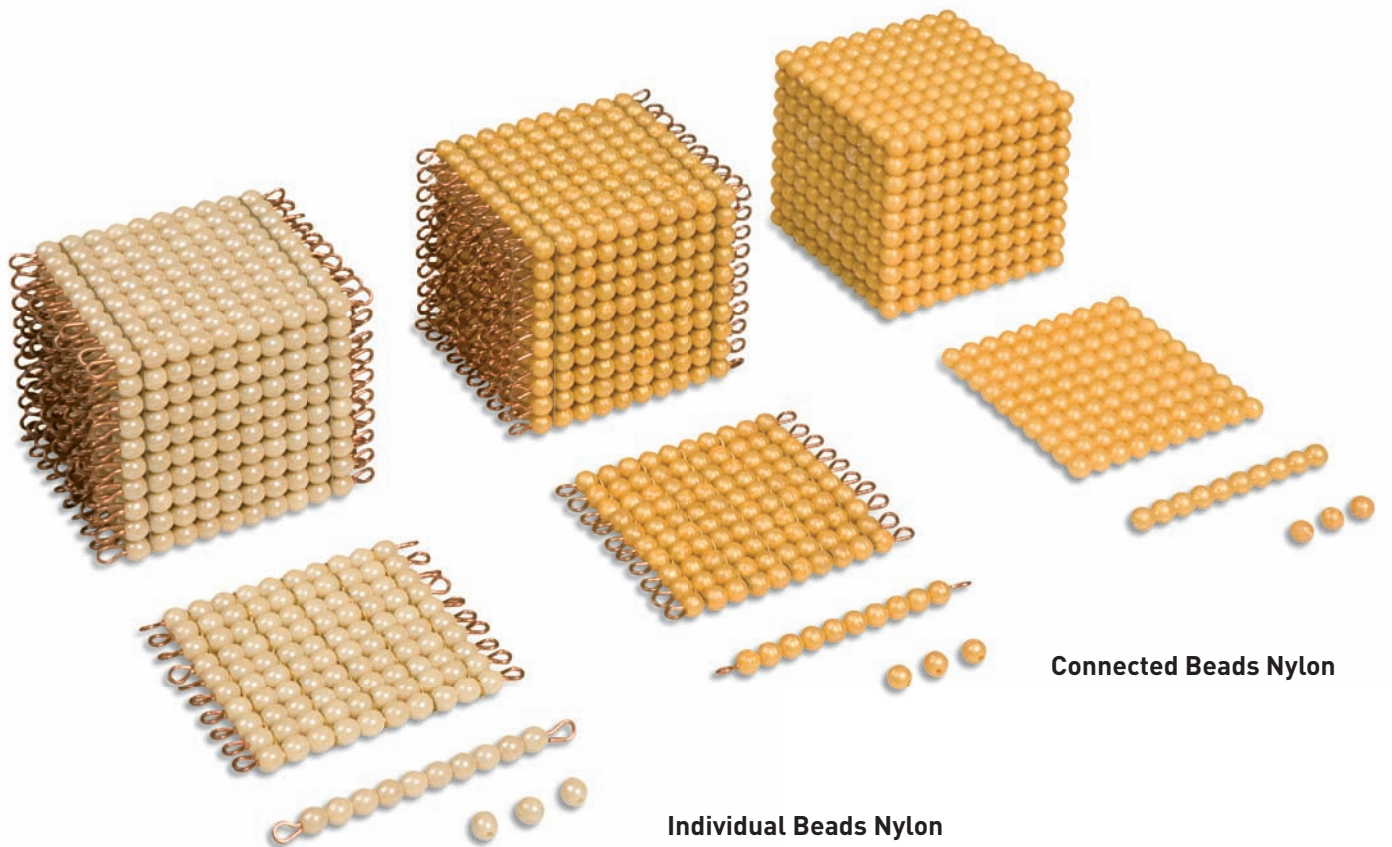

Individual Beads Glass

Individual Beads Nylon

Connected Beads Nylon

### Introduction To Decimal Quantity

A tray containing Golden Bead Materials used in the introduction of the decimal quantities of 1, 10, 100 and 1000 (cards not included).

**Item Number: 0.250.00 - Connected Beads Nylon**

**Item Number: 0.250.G0 - Individual Beads Glass (pictured)**

**Item Number: 0.250.M0 - Individual Beads Nylon**

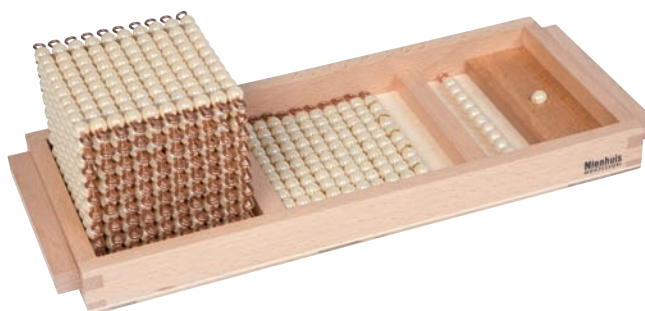

### Introduction To Decimal Symbol

A wooden box containing plastic number cards used for the introduction of the values of 1, 10, 100 and 1000.

**Item Number: 0.251.00**

### Introduction To The Decimal System

A concrete representation of the decimal system 1 to 1000, which demonstrates place value and the concept that a decimal category can not exceed 9. The set includes: 9 individual unit beads, 9 bars of 10, 9 squares of 100, 1 cube of 1000, 3 wooden boxes, 1 wooden unit tray, and a wooden tray.

**Item Number: 0.252.00 - Connected Beads Nylon**

**Item Number: 0.252.G0 - Individual Beads Glass (pictured)**

**Item Number: 0.252.M0 - Individual Beads Nylon**



## Golden Bead Material

The Golden Bead Material introduces the child to the decimal system with concrete representations of the hierarchy of numbers. Quantity and place value is explored by the child through activities in the operations of addition, subtraction, multiplication and division.

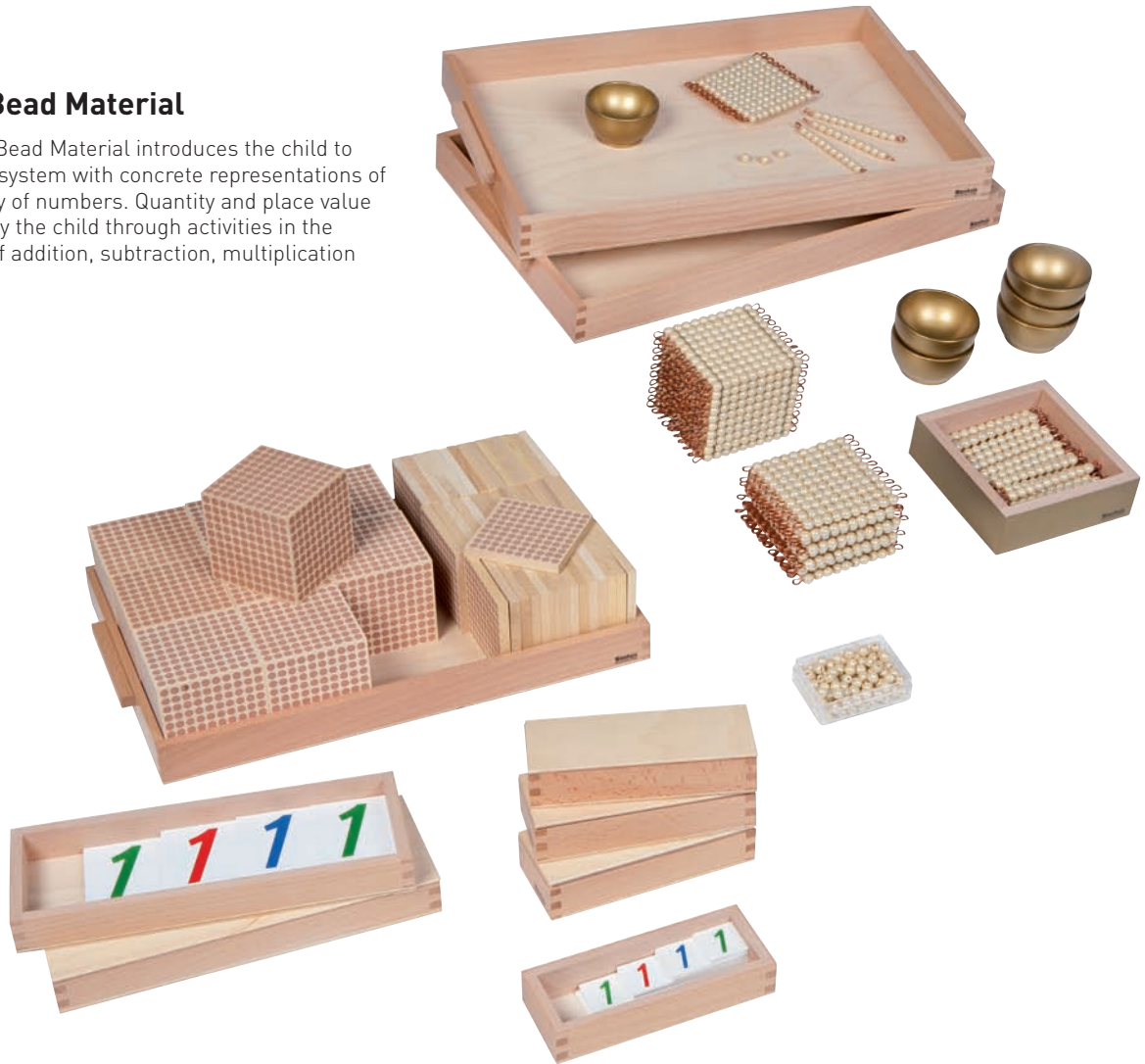

### The Set Contains:

- 100 - Golden Bead Units in a plastic box
- 45 - Golden Bars of 10 in box
- 10 - Golden Bead Squares of 100
- 45 - Wooden Squares of 100
- 1 - Golden Bead Cube of 1000
- 9 - Wooden Cubes of 1000
- 3 - Boxes containing the Small Number Cards 1-3000
- 1 - Box containing the Small Number Cards 1-9000
- 1 - Box containing the Large Number Cards 1-1000
- 1 - Box containing the Large Number Cards 1-9000
- 3 - Wooden trays each with 2 Unit Bead Cups

### Golden Bead Material

**Item Number: 0.083.C0 - Connected Beads Nylon**

**Item Number: 0.083.GC - Individual Beads Glass (pictured)**

**Item Number: 0.083.MC - Individual Beads Nylon**

### Golden Bead Material Activity Set

Additional exercises for use with The Golden Bead Material. Includes: exercise cards, divider tabs and a wooden box for storage.

**Item Number: 0.600.01**



## Individual Golden Bead Material

The items that make up the set of Golden Bead Material are also available individually in each of the bead types.



### One Golden Bead Cube Of 1000

Item Number: 0.085.00 - Connected Beads Nylon

Item Number: 0.085.G0 - Individual Beads Glass (pictured)

Item Number: 0.085.M0 - Individual Beads Nylon

### One Golden Bead Square Of 100

Item Number: 0.084.A0 - Connected Beads Nylon

Item Number: 0.084.G0 - Individual Beads Glass (pictured)

Item Number: 0.084.AM - Individual Beads Nylon



### 45 Golden Bars Of 10 In Box

Item Number: 0.076.00 - Connected Beads Nylon

Item Number: 0.076.G0 - Individual Beads Glass (pictured)

Item Number: 0.076.M0 - Individual Beads Nylon

### 100 Golden Bead Units

Item Number: 0.077.00 - Solid Beads Nylon (without hole)

Item Number: 0.077.G0 - Individual Beads Glass (with hole) (pictured)

Item Number: 0.077.M0 - Individual Beads Nylon (with hole)





**Wooden Square Of 100: Set Of 10**  
Item Number: 0.074.10

**Paper For Recovering Squares And Cubes: (100)**  
Item Number: 0.074.A0

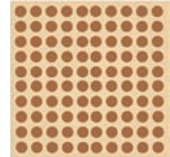

**Wooden Cube Of 1000: Set Of 10**  
Item Number: 0.075.10

**Wooden Tray With 2 Unit Cups**  
Item Number: 0.081.00





**Large Number Cards Box**  
Item Number: 0.069.A0



**Small Number Cards Box**  
Item Number: 0.070.A0

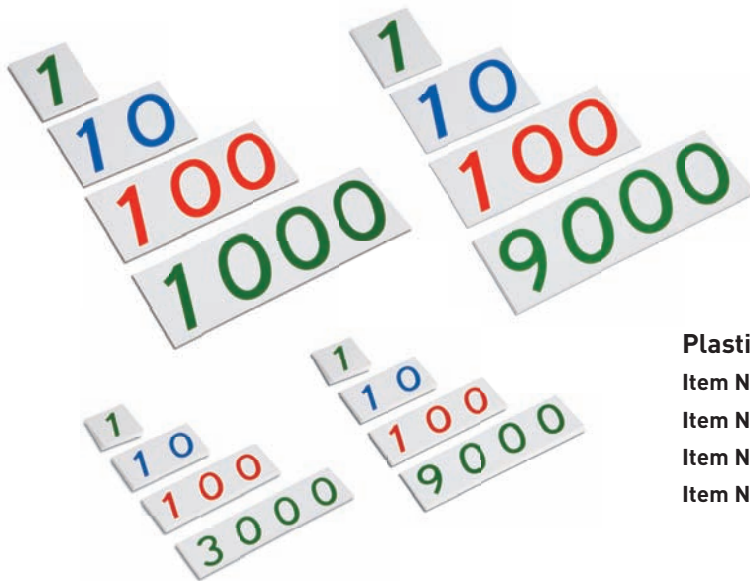

**Plastic Number Cards**

Item Number: 0.069.C0 - Large Number Cards, 1-1000

Item Number: 0.070.C0 - Small Number Cards, 1-3000

Item Number: 0.071.C0 - Small Number Cards, 1-9000

Item Number: 0.072.C0 - Large Number Cards, 1-9000

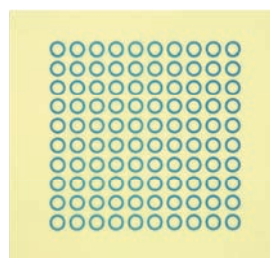

**Sheet With 100 Circles**

Printed in blue on yellow paper.

**Item Number: 0.141.00**

## Wooden Number Cards

The Wooden Number Cards are printed on wood and are finished with a clear varnish. A box is included to facilitate handling and storage.

### Wooden Number Cards: Large 1-9000

Item Number: 0.072.B0



### Wooden Number Cards: Small 1-9000

Item Number: 0.071.B0



## Arithmetic Signs Box

A collection of arithmetic signs ( + - x ÷ = ) and number cards for use with the various mathematics materials. Includes beechwood box for storage.

Item Number: 0.260.00





### Stamp Game

After being introduced to the decimal system using the Golden Bead Material, the Stamp Game provides opportunity for individual practice in the operations of addition, subtraction, multiplication and division. In a step towards abstraction, the quantity and symbols of the decimal system are combined and are represented by each 'stamp'.

**Item Number: 0.082.00**





### Stamp Game Activity Set

Additional exercises for use with the Stamp Game. Includes: exercise cards, tab divider cards and a wooden box for storage.

**Item Number: 0.601.01**

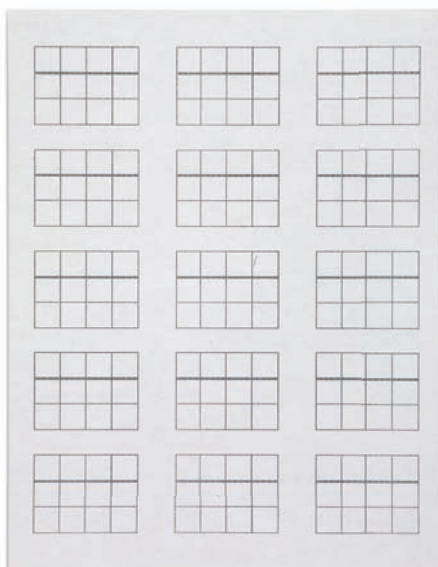

### Stamp Game Paper: 15 Problems

500 sheets with 15 problem grids (twelve 1/2" - squares each) printed in grey.

**Item Number: 5.583.00**

### Dot Exercise

The Dot Exercise provides practice in decimal system addition. Through use, the child further explores column addition and experiences the mechanism of 'carrying.' The Dot Exercise grid is printed on a whiteboard upon which the child writes with water based pens of 2 different colors. 2 pens included.

**Item Number: 0.050.50**

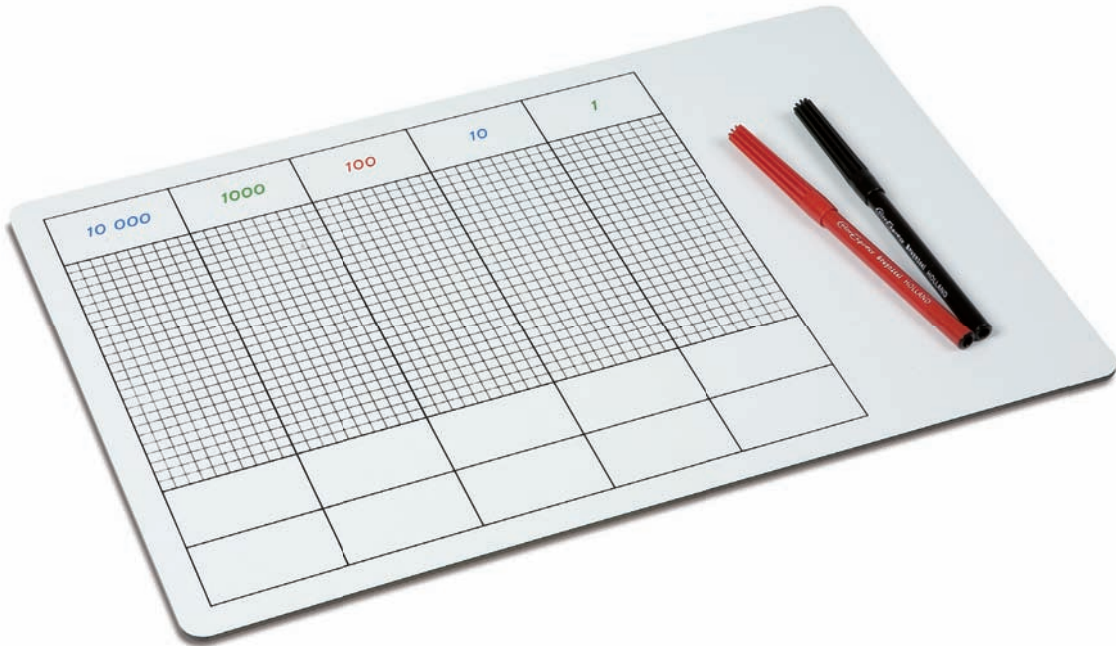

#### Water Based Pens: Red (10)

For use with the Dot Exercise board.

**Item Number: 0.050.53**



#### Water Based Pens: Black (10)

For use with the Dot Exercise board.

**Item Number: 0.050.54**

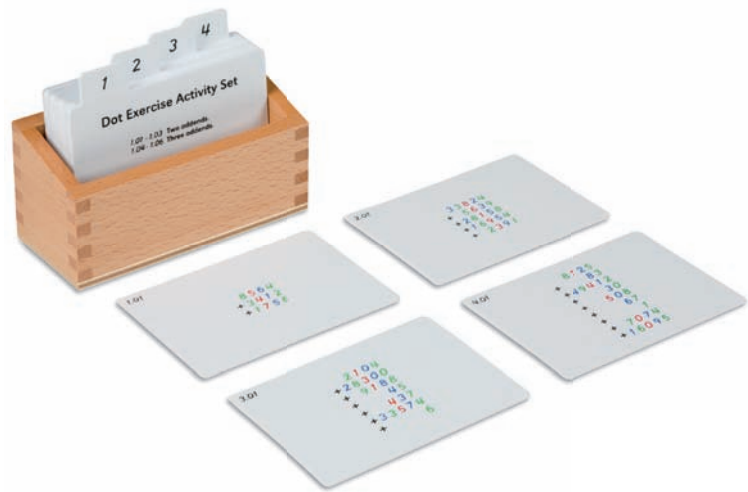

## Dot Exercise Activity Set

Additional exercises for use with the Dot Exercise. Includes: exercise cards, tab divider cards and a wooden box for storage.

**Item Number: 0.606.01**

## Dot Exercise Sheets: (50)

50 sheets printed with the Dot Exercise board grid.

**Item Number: 0.050.A0**



## Teen Boards

Using the Teen Boards, the child explores the numbers 11-19. Bead quantities are created from the 10 bars and colored bead stair in the Teen Bead Box and are associated with the corresponding numeral on the Teen Boards. Includes a wooden box with lid containing two Teen Boards and nine wooden cards.



**Teen Boards: Print**  
Item Number: 0.030.00



**Teen Boards: Cursive**  
Item Number: 0.030.01

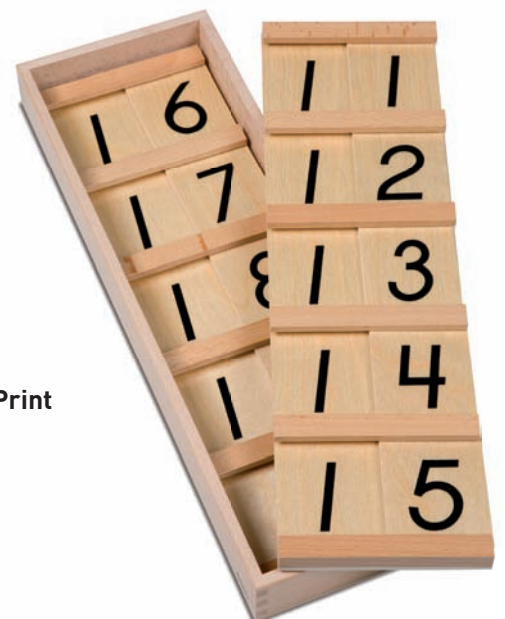

**Teen Boards: USA Style Print**  
Item Number: 0.030.03



**Teen Bead Box: Connected Beads Nylon**

Item Number: 0.030.A0



**Teen Bead Box: Individual Beads Nylon**

Item Number: 0.030.AM



**Teen Bead Box: Individual Beads Glass**

Item Number: 0.030.AG



## Tens Boards

Using the Tens Boards, the child explores the number names of the tens and the sequence of numbers 11-99. Bead quantities are created from the 10 bars and unit beads in the Tens Bead Box and are associated with the corresponding numeral on the Tens Board. Includes a wooden box with lid containing 2 Tens Boards and 9 wooden cards printed with the numerals 1-9. 1 board has five printed number slots (10-50), the other has four printed number slots (60-90).

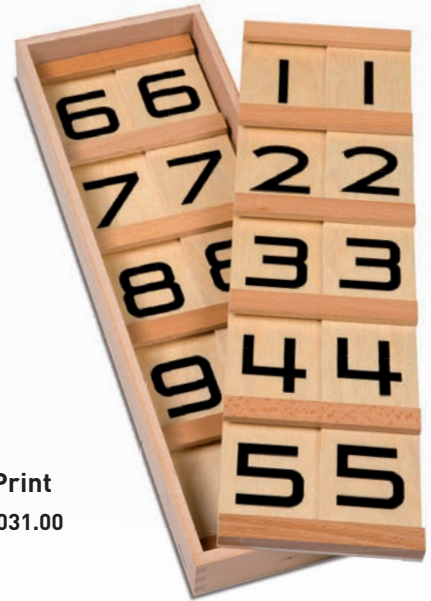

**Tens Boards: Print**  
Item Number: 0.031.00



**Tens Boards: Cursive**  
Item Number: 0.031.01

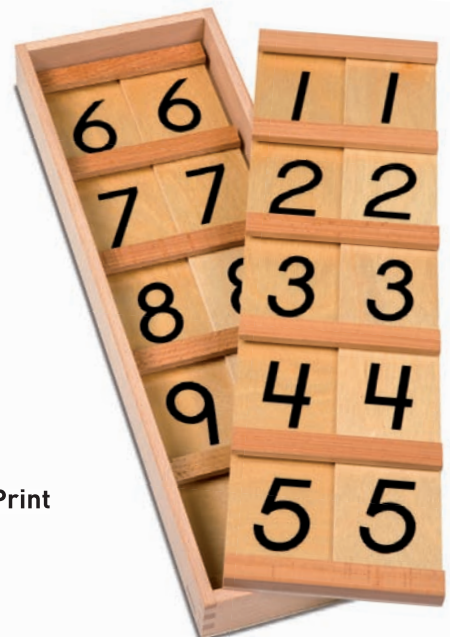

**Tens Boards: USA Style Print**  
Item Number: 0.031.03



### **Tens Bead Box: Connected Beads Nylon**

Contains 9 bars of 10 and 9 unit beads.

**Item Number: 0.031.A0**

### **Tens Bead Box: Individual Beads Glass**

Contains 9 bars of 10 and 9 unit beads.

**Item Number: 0.031.AG**



### **Tens Bead Box: Individual Beads Nylon**

Contains 9 bars of 10 and 9 unit beads.

**Item Number: 0.031.AM**

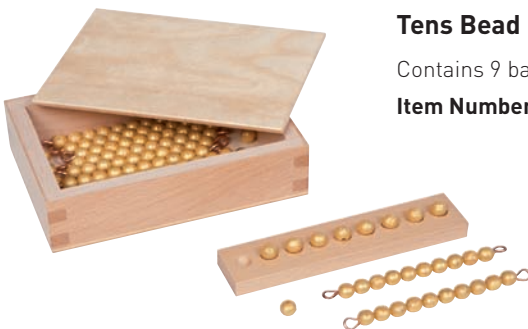



### Hundred Board

A material used for teaching the number sequence from 1 to 100. The material consists of a wooden board printed with 100 squares and a box with lid containing wooden chips printed with the numbers 1-100.

**Item Number: 0.180.00**

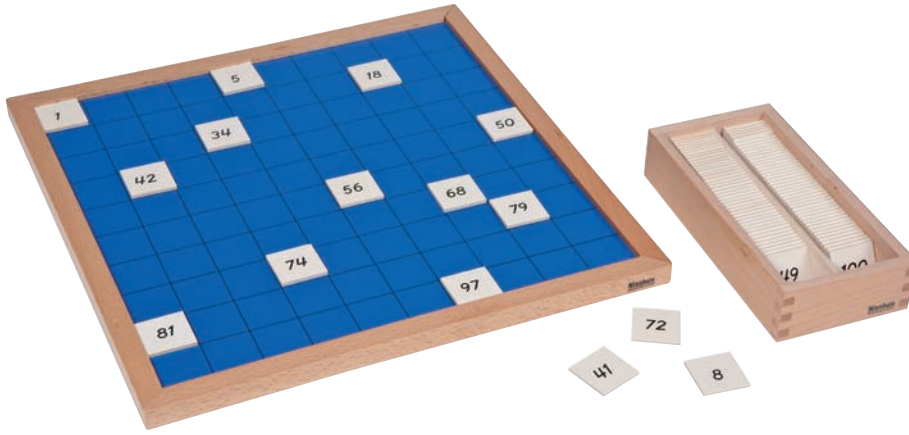

### Control Chart: Hundred Board

This control chart makes it possible for children to work independently and correct their own errors.

**Item Number: 0.157.00**

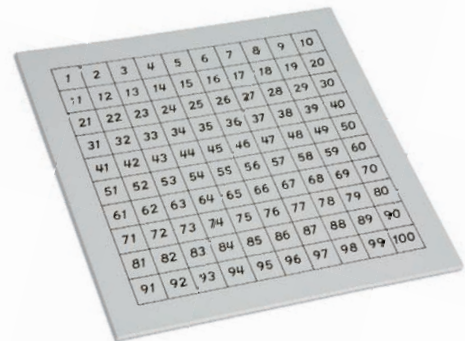

### Hundred Board Activity Set

Additional exercises for use with the Hundred Board. Includes exercise cards, tab divider cards and a wooden box for storage.

**Item Number: 0.612.01**

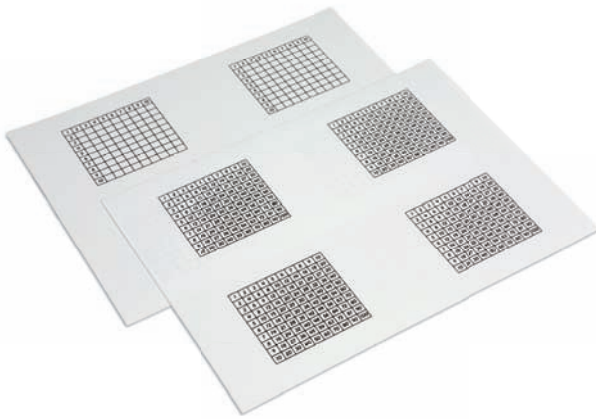

## Hundred Board Copy Masters

A set of plastic sheets for copying.

**Item Number: 0.612.51**

## Hundred Board With Roman Numerals

A material for use after the child has mastered the original Hundred Board. The concept is the same, but this version is printed with Roman numerals. The material consists of a wooden board printed with 100 squares and a box with lid containing wooden chips printed with the Roman numerals 1-100.

**Item Number: 0.180.50**

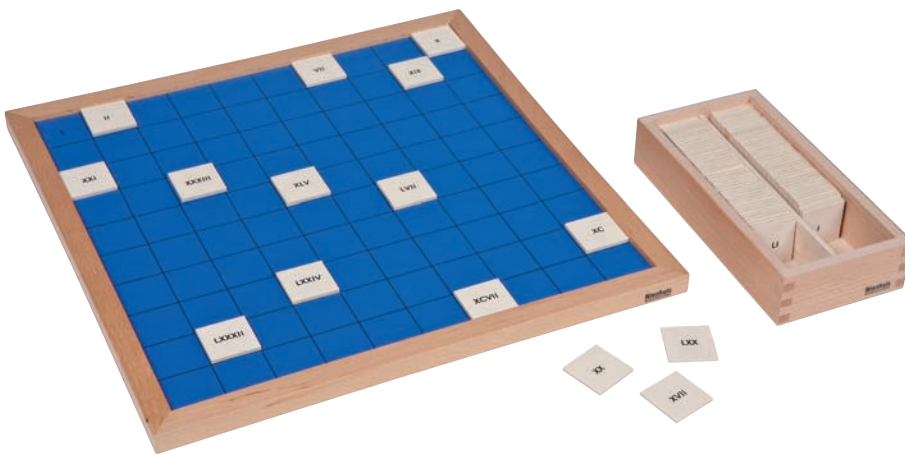

## Control Chart: Hundred Board With Roman Numerals

This control chart makes it possible for children to work independently and correct their own errors.

**Item Number: 0.157.B0**

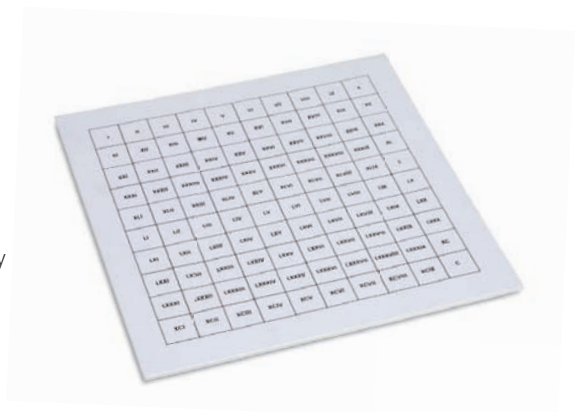

### Rug For Large Numeral Cards

A rug with 100 squares to use as the 'board' for laying out the Large Numeral Cards on the floor. Rug size: 150 x 150 cm.

**Item Number: 0.672.00**

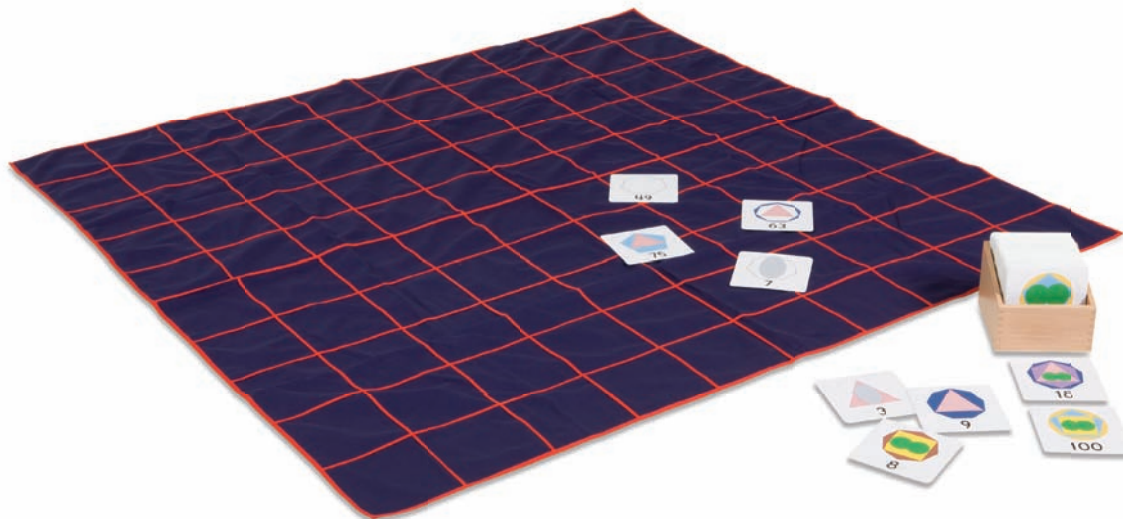

### Box With Large Numeral Cards

A set of 100 plastic cards (13.5 x 13.5 cm) printed with numbers and geometric figures. Used for teaching counting to 100, learning prime numbers, common multiples and more. Includes a wooden box for storing the cards.

**Item Number: 0.671.00**

### Rug For Small Numeral Cards

A rug with 100 squares to use as the "board" for laying out the Small Numeral Cards on the floor. Rug size: 80 x 80 cm.

**Item Number: 0.674.00**

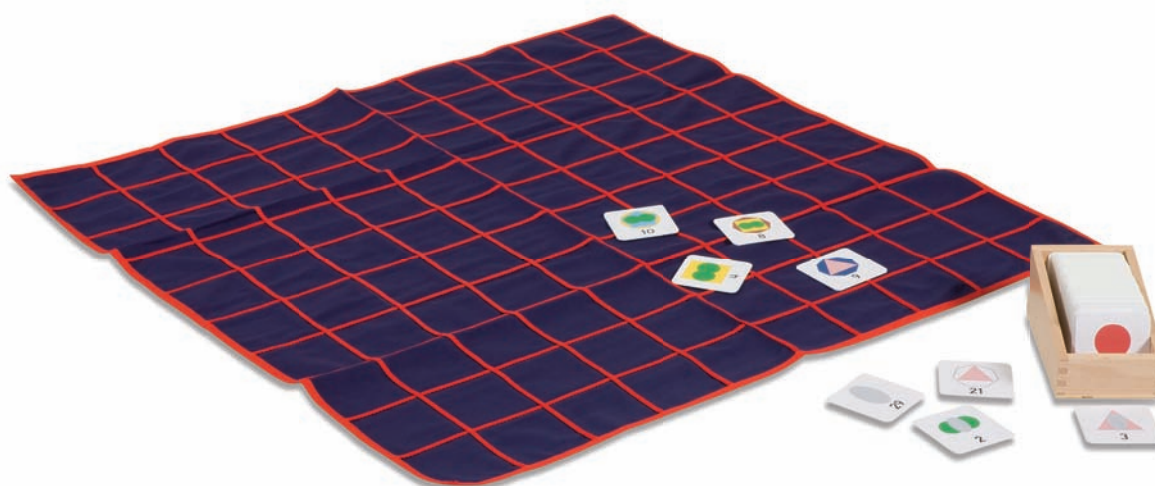

### Box With Small Numeral Cards

A set of 100 plastic cards (7 x 7 cm) printed with numbers and geometric figures. Used for teaching counting to 100, learning prime numbers, common multiples and more. Includes a wooden box for storing the cards.

**Item Number: 0.673.00**

## Pythagoras Board

A material used for teaching the multiplication tables. The material consists of a wooden board printed with 100 squares and a box with lid containing printed wooden answer chips.

**Item Number: 0.181.00**

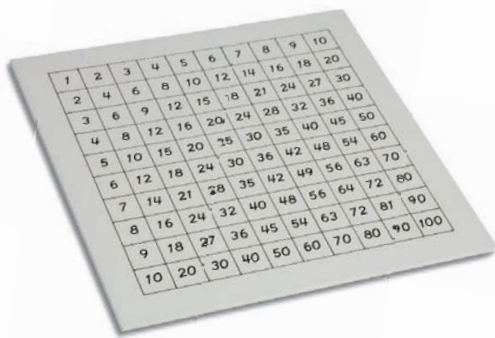
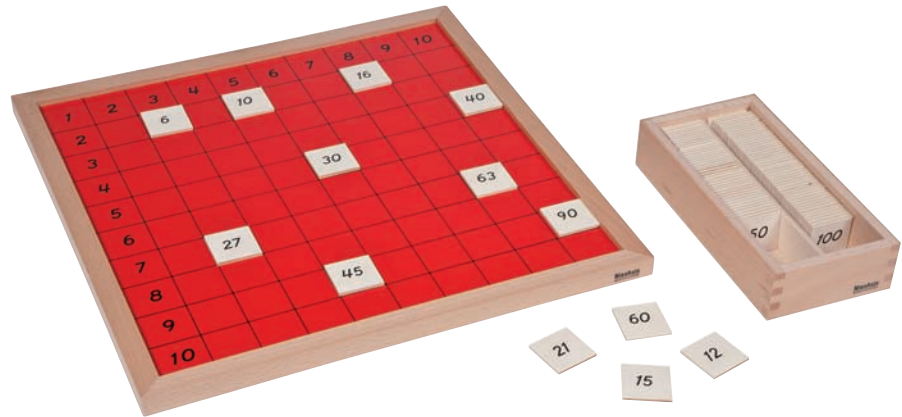

## Control Chart: Pythagoras Board

This control chart makes it possible for children to work independently and correct their own errors.

**Item Number: 0.157.A0**

## Pythagoras Board Copy Masters

A set of plastic sheets for copying.

**Item Number: 0.622.51**



## Pythagoras Board Activity Set

Additional exercises for use with the Pythagoras Board. Includes exercise cards, tab divider cards and a wooden box for storage.

**Item Number: 0.622.01**

## Golden Bead Chain Of 100

Provides experience in counting from 1-100, reinforces the sequence of number, prepares the child for counting by tens and demonstrates in linear form the square of 100.

### Connected Beads Nylon

Item Number: 0.078.00



### Individual Beads Glass

Item Number: 0.078.G0



### Individual Beads Nylon

Item Number: 0.078.M0



### 100 And 1000 Chains Frame

A wooden wall frame for hanging the 100 and 1000 chains.

Item Number: 0.079.A0

### Printed Arrows: 100/1000 Bead Chains

2 sets of decimal system color-coded plastic arrows, for both the 100 and 1000 chains. 2 plastic storage boxes are included.

Item Number: 0.079.B0



## Golden Bead Chain Of 1000

This activity provides experience in counting from 1-1000, prepares the child for multiplication and demonstrates in linear form the cube of 1000.

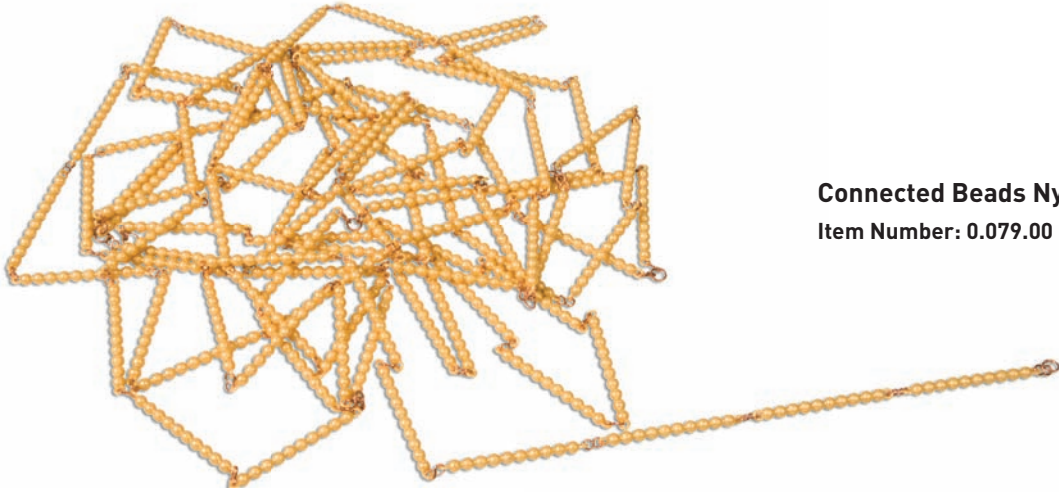

**Connected Beads Nylon**  
Item Number: 0.079.00

**Individual Beads Glass**  
Item Number: 0.079.G0

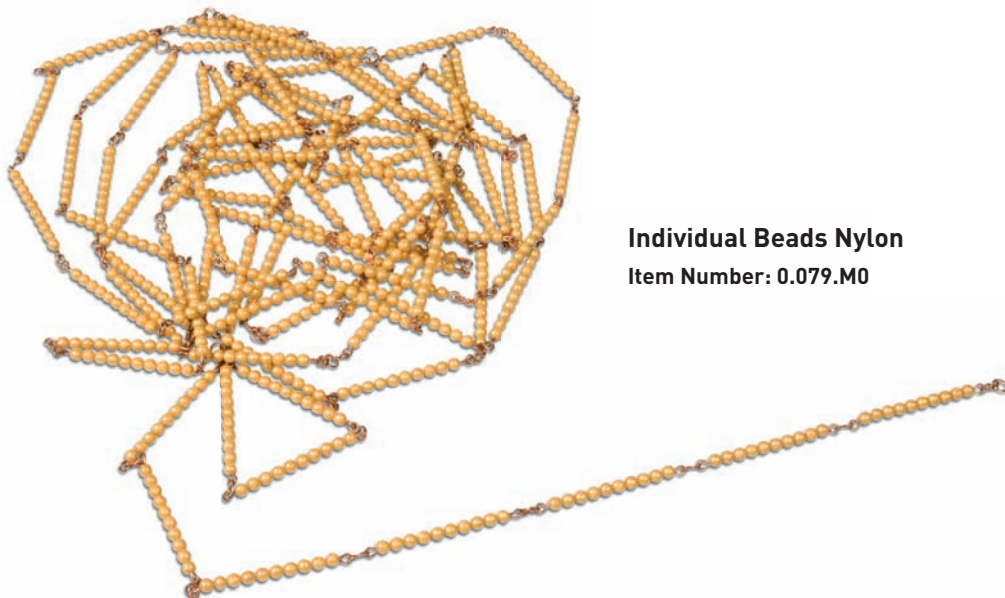

**Individual Beads Nylon**  
Item Number: 0.079.M0

### Short Bead Chains

The exercises of the Short Bead Chains prepare the child for multiplication as he 'skip-counts' the bead chains. Also included is a bead square for each number 1-10.

**Item Number: 0.080.00 - Connected Beads Nylon**

**Item Number: 0.080.G0 - Individual Beads Glass (pictured)**

**Item Number: 0.080.M0 - Individual Beads Nylon**



### Printed Arrows: Short Bead Chains

10 sets of color-coded plastic arrows with the multiples printed on them for use in the skip-counting exercises with the Short Bead Chains. 10 plastic boxes are included.

**Item Number: 0.080.B0**



### Short Bead Chains Frame

A wooden wall frame for hanging the Short Bead Chains 1-10.

**Item Number: 0.080.A0**

## Bead Material

This extensive set of Bead Material is used for teaching the exercises of linear and skip-counting the quantities of the squares and cubes of the numbers 1-10. It prepares the child for later activities in multiplication, squaring and cubing, as well as base number work.

**Item Number: 0.086.00 - Connected Beads Nylon**

**Item Number: 0.086.G0 - Individual Beads Glass (pictured)**

**Item Number: 0.086.M0 - Individual Beads Nylon**

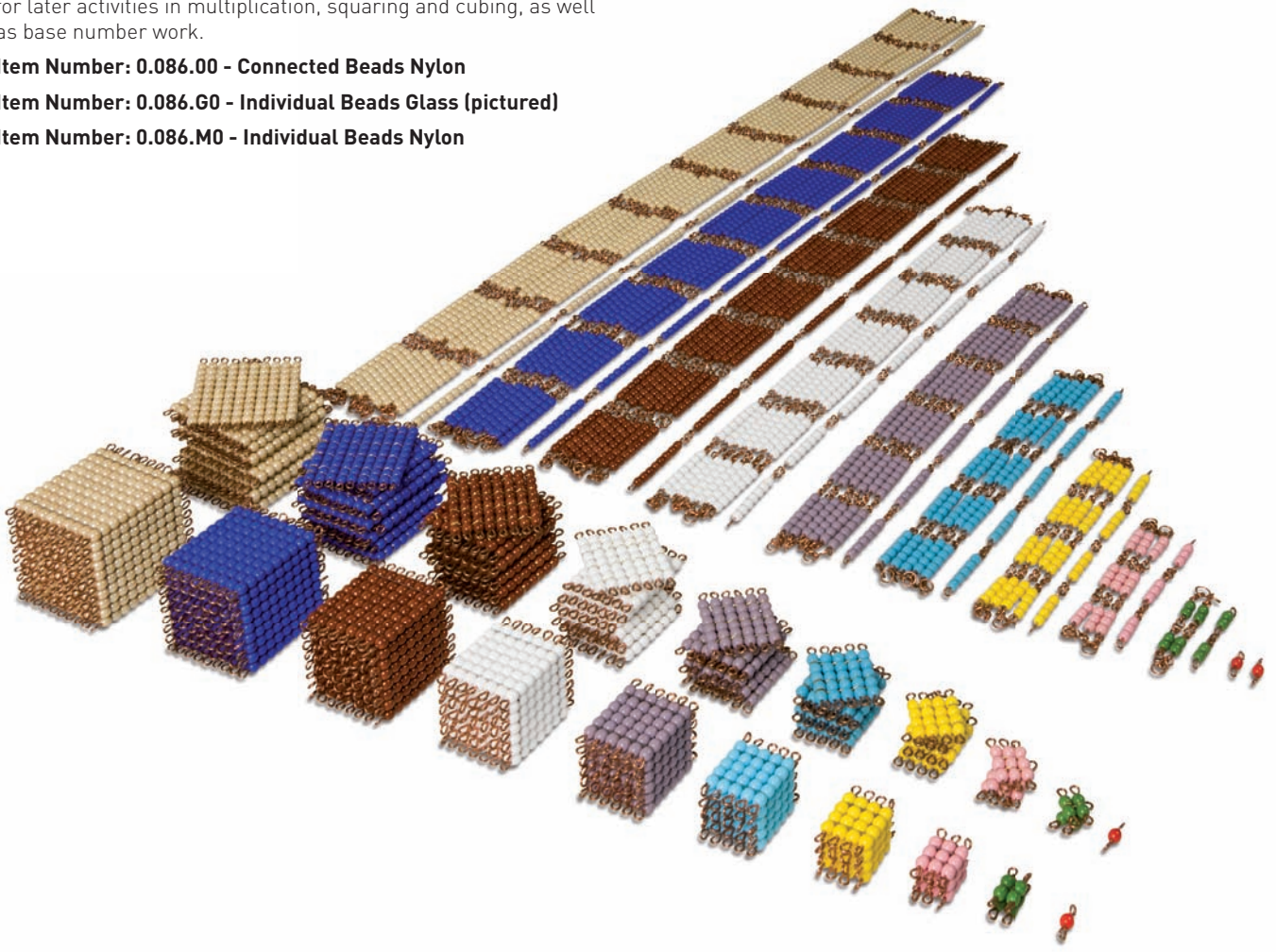

## Printed Arrows: The Bead Material

20 sets of color-coded plastic arrows with the multiples printed on them for use in the skip counting exercises with the short and long bead chains. The arrows of each chain are 1/4" wide for the units, 1/2" wide for the multiples, 3/4" wide for squares, and 1" wide for cubes. 20 plastic boxes are included.

**Item Number: 0.086.B0**



**Bead Material Cabinet**

This cabinet is designed to display the Bead Material. 95 x 120 x 14 cm (bead material not included).

**Item Number: 1.760.00**



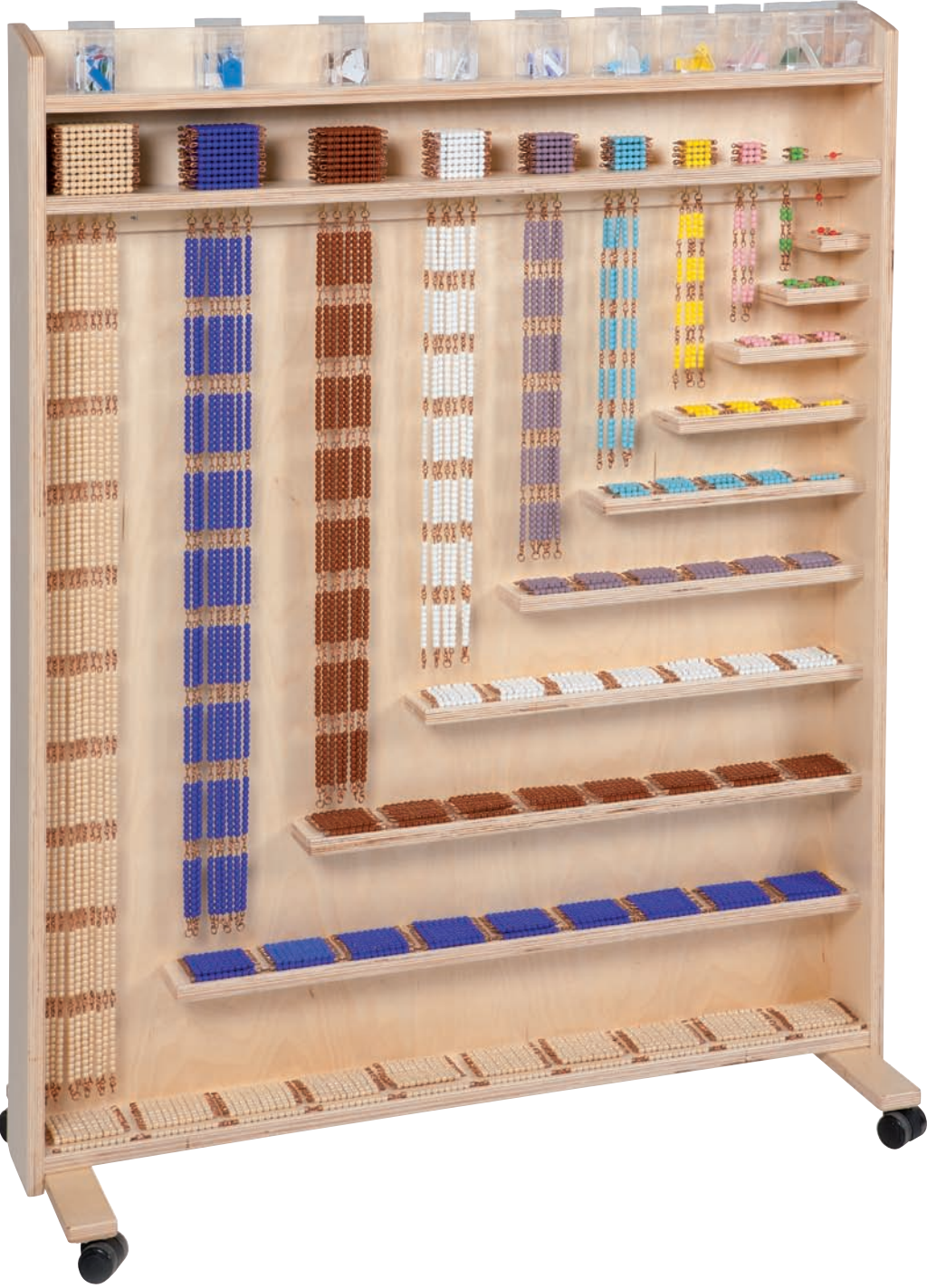

## Colored Bead Stairs

The Colored Bead Stairs are used for activities of addition, subtraction and multiplication. Includes a hardwood box with lid.



Item Number: 0.090.00 - Connected Beads Nylon: 5 Sets

Item Number: 0.090.G0 - Individual Beads Glass: 5 Sets (pictured)

Item Number: 0.090.M0 - Individual Beads Nylon: 5 Sets

Item Number: 0.090.A0 - Connected Beads Nylon: 10 Sets

Item Number: 0.090.AG - Individual Beads Glass: 10 Sets (pictured)

Item Number: 0.090.AM - Individual Beads Nylon: 10 Sets



## Black And White Bead Stairs

These Bead Stairs are used in addition and subtraction activities.



Item Number: 0.091.00 - Connected Beads Nylon: 5 Sets

Item Number: 0.091.G0 - Individual Beads Glass: 5 Sets (pictured)

Item Number: 0.091.M0 - Individual Beads Nylon: 5 Sets



Item Number: 0.091.A0 - Connected Beads Nylon: 1 Set

Item Number: 0.091.AG - Individual Beads Glass: 1 Set (pictured)

Item Number: 0.091.AM - Individual Beads Nylon: 1 Set

## Addition Snake Game

The Addition Snake Game introduces the child to addition combinations of the unit numbers. Contains 1 box with 5 sets of Colored Bead Stairs, 1 box with 1 set of Black And White Bead Stairs, and 1 box with 23 Golden Bars Of 10. The 3 boxes fit neatly into a beechwood tray.

**Item Number: 0.290.00 - Connected Beads Nylon**

**Item Number: 0.290.G0 - Individual Beads Glass (pictured)**

**Item Number: 0.290.M0 - Individual Beads Nylon**



## Addition Strip Board

Using the Addition Strip Board, the child practices the sequence of addition combinations 1-9, and begins the process of memorization of the addition tables. The material is composed of a chart 12 squares by 18 squares with the numbers 1-18 printed across the top. Stored in a hardwood box are the strips used for the exercise, 9 red strips divided into squares and 9 solid blue strips, both printed with the numerals 1-9.

**Item Number: 0.092.00**

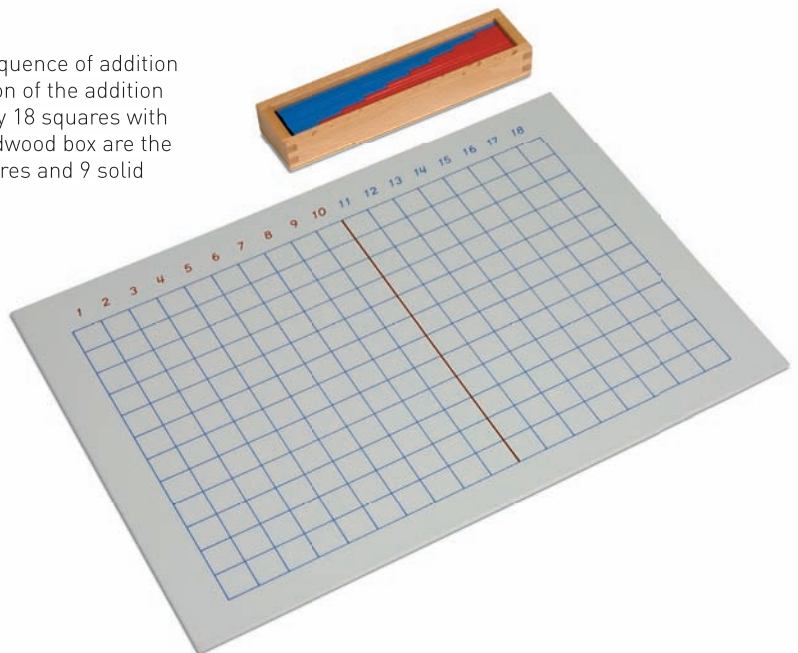

## Addition Tables

The Addition Tables contain the equations necessary for performing the Addition Strip Board exercises. 9 sheets per set, 5 complete sets provided.

**Item Number: 0.144.01**



**Addition Working Charts**

The Addition Working Charts aid the child in the practice and memorization of the unit addition combinations. Includes 2 control charts, 4 working charts and 1 box of wooden answer chips.

**Item Number: 0.142.A0**

**Working Chart Equation Paper**

500 sheets with 10 rows of 5 squares printed in black on white paper. Used for memorization exercises.

**Item Number: 5.586.00**



**Problem Slips: Addition Working Charts**

4 sets of color-coded unit addition combinations (equations) slips. 1 set of combinations for each of the four Addition Working Charts. Each set supplied in a separate plastic box.

**Item Number: 5.595.24**



## Addition Equations And Sums Box

This 2-compartment box with lid contains plastic chips, 1 set with equations printed on them and 1 set with the answers to be used with the Addition Working Charts. All the equations and sums for the addends 1-9 are included.

**Item Number: 0.146.00**

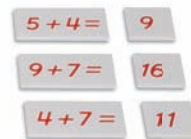

## Addition Tables Booklet: 1

The "traditional" addition tables for the numbers 1-9 with second addend in numerical order, i.e. table of 1: 1+1= thru 1+9= (40 booklets).

**Item Number: 5.595.21**



## Addition Tables Booklet: 2

Addition tables 1-9 presented with second addends in random order. These booklets encourage further practice and repetition (40 booklets).

**Item Number: 5.595.22**

## Addition Tables Booklet: 3

A 9-page booklet with random addition equations. These booklets encourage further practice and repetition (40 booklets).

**Item Number: 5.595.23**

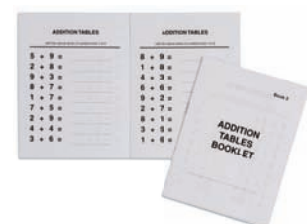

### Subtraction Snake Game

The purpose of this material is to introduce the child to the unit combinations of subtraction.  
Includes: 1 box containing 5 sets of Negative Bead Stairs, 1 box containing 5 sets of Colored Bead Stairs, 1 box containing 23 Golden Bars Of 10, and 1 box containing 1 Black And White Bead Stair  
The 4 boxes fit neatly into a beechwood tray.

**Item Number: 0.291.00 - Connected Beads Nylon**

**Item Number: 0.291.G0 - Individual Beads Glass (pictured)**

**Item Number: 0.291.M0 - Individual Beads Nylon**



### Elementary Negative Snake Game

This material is used to introduce the concept of negative numbers. The material consists of a presentation tray containing 6 boxes of Bead Material, 1 box containing 5 sets of Colored Bead Stairs, 1 box containing 5 sets of Negative Bead Stairs, 1 box containing 1 Black And White Bead Stair, 1 box containing 23 Golden Bars Of 10, 1 box containing 1 Red And White Bead Stair and 1 box containing 23 Grey 10 Bars.

**Item Number: 0.292.00 - Connected Beads Nylon**

**Item Number: 0.292.G0 - Individual Beads Glass (pictured)**

**Item Number: 0.292.M0 - Individual Beads Nylon**



## Subtraction Equations And Differences Box

This 2-compartment box with lid contains plastic chips, 1 set with equations printed on them and 1 set with the answers to be used with the Subtraction Working Charts. All the equations and differences for the subtraction combinations 1-18 are included.

**Item Number: 0.147.00**



## Subtraction Strip Board

Using the Subtraction Strip Board, the child practices the equations of the subtraction tables 1-18. Natural wooden strips corresponding in length to the squares 1-18 are used to indicate the number to subtract from (minuend) and 1 set of blue strips used to subtract with (subtrahend). A set of red strips is included for further explorations. The 2 sets of strips are stored in hardwood boxes.

**Item Number: 0.092.A0**

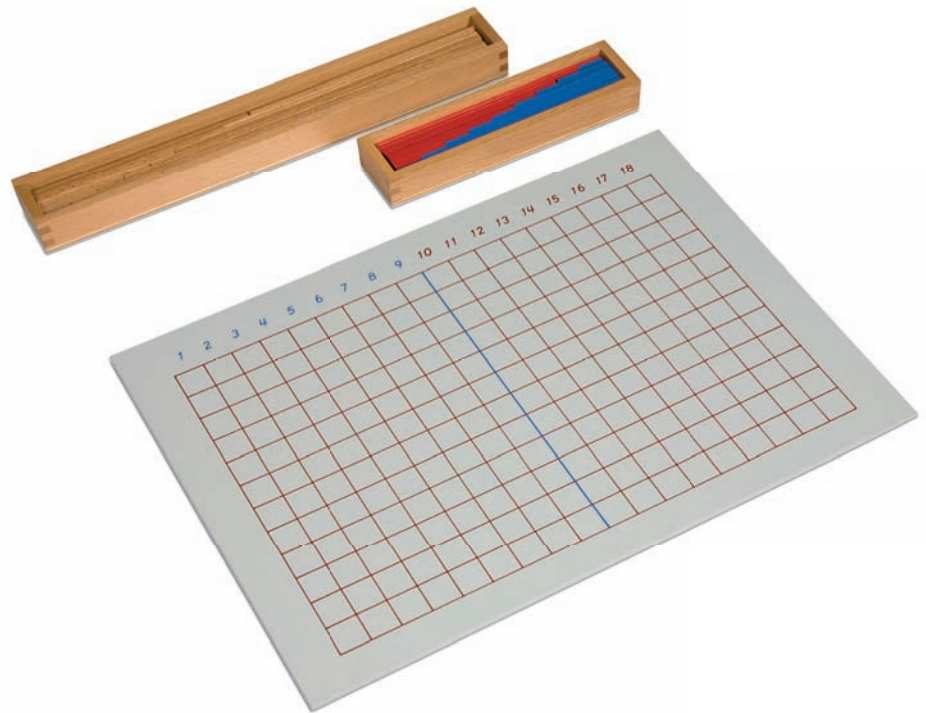

## Subtraction Working Charts

The Subtraction Working Charts aid the child in practice and memorization of the subtraction combinations. Includes a control chart, 2 working charts and a box of wooden answer chips.

**Item Number: 0.142.B0**

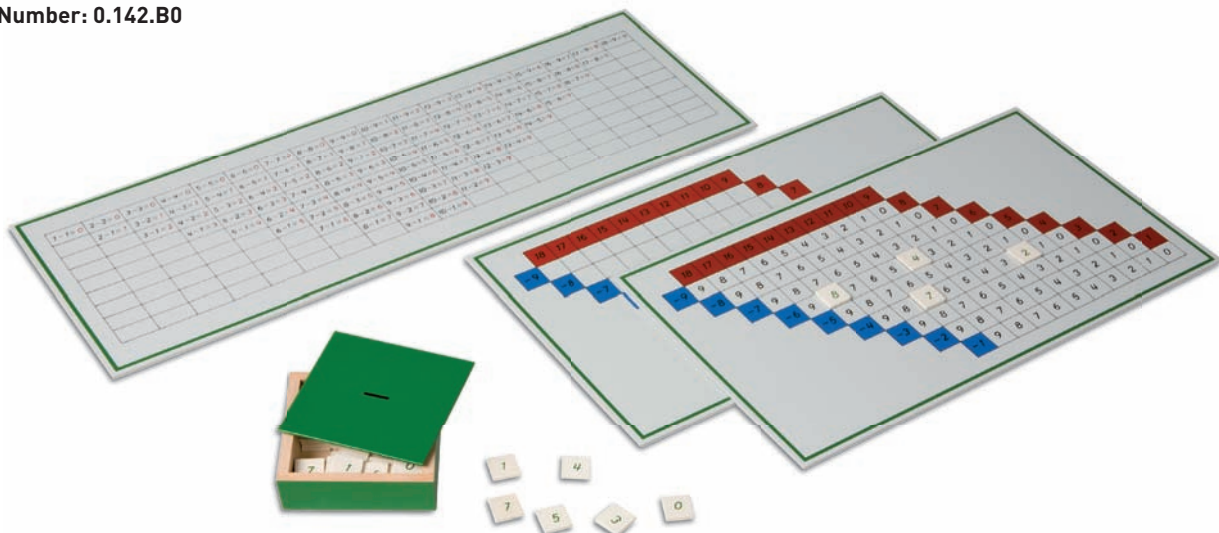



### Working Chart Equation Paper

500 sheets with 10 rows of 5 squares printed in black on white paper. Used for memorization exercises.

**Item Number: 5.586.00**



### Subtraction Tables

The Subtraction Tables contain the equations necessary for performing the Subtraction Strip Board exercises. 18 sheets per set, 10 complete sets provided.

**Item Number: 0.143.01**

### Subtraction Tables Booklet: 1

The "traditional" subtraction tables for the numbers 18-1 with subtrahends in diminishing numerical order (24 booklets).

**Item Number: 5.595.31**



### Subtraction Tables Booklet: 2

Subtraction tables 18-1 presented with subtrahends in random order. These booklets encourage further practice and repetition (24 booklets).

**Item Number: 5.595.32**



### Subtraction Tables Booklet: 3

A booklet with random subtraction equations. These booklets encourage further practice and repetition (40 booklets).

**Item Number: 5.595.33**



### Problem Slips: Subtraction Working Charts

2 sets of color-coded unit subtraction combinations (equations) slips. 1 set of combinations for each of the 2 Subtraction Working Charts. Each set supplied in a separate plastic box.

**Item Number: 5.595.34**

## Multiplication Bead Bar Layout Box

The purpose of this material is to introduce the child to the multiplication tables 1 x 1 through 10 x 10. The box contains the appropriate amount of bead bars 1-10 to layout each table and its corresponding product.

**Item Number: 0.280.00 - Connected Beads Nylon**

**Item Number: 0.280.G0 - Individual Beads Glass (Pictured)**

**Item Number: 0.280.M0 - Individual Beads Nylon**



## Bead Houses

Used to help isolate the possible number combinations of 1 -10, the 'Bead Houses' are made of durable plastic and color-coded to correspond with the Bead Material. To be used with the Colored Bead Bars and Cut-Out Numerals. Set includes: 10 plastic cards, each shaped like a house, and a wooden box with lid for storage.

**Item Number: 0.088.00**



### Multiplication Board

The Multiplication Board is used for practice with the multiplication tables 1 x 1 through 10 x 10.

**Item Number: 0.087.00**

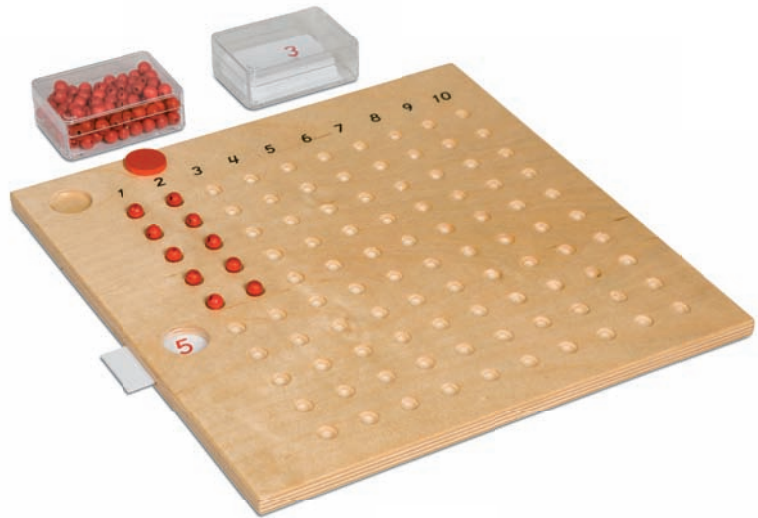

### Multiplication Board Activity Set

Additional exercises for use with the Multiplication Board. Includes: exercise cards, tab divider cards and a wooden box for storage.

**Item Number: 0.621.01**

### Multiplication Tables

The Multiplication Tables contain the equations necessary for the exercises with the Multiplication Board. 10 sheets per set, 5 complete sets provided.

**Item Number: 0.155.01**



## Multiplication Snake Game

The purpose of this material is to introduce the child to the unit combinations of multiplication. Includes 1 box containing 5 sets of Colored Bead Stairs, 1 box containing 23 Golden Bars Of 10, and 1 box containing 1 Black And White Bead Stair. The 3 boxes fit neatly into a beechwood tray.

**Item Number: 0.293.00 - Connected Beads Nylon**

**Item Number: 0.293.G0 - Individual Beads Glass (pictured)**

**Item Number: 0.293.M0 - Individual Beads Nylon**

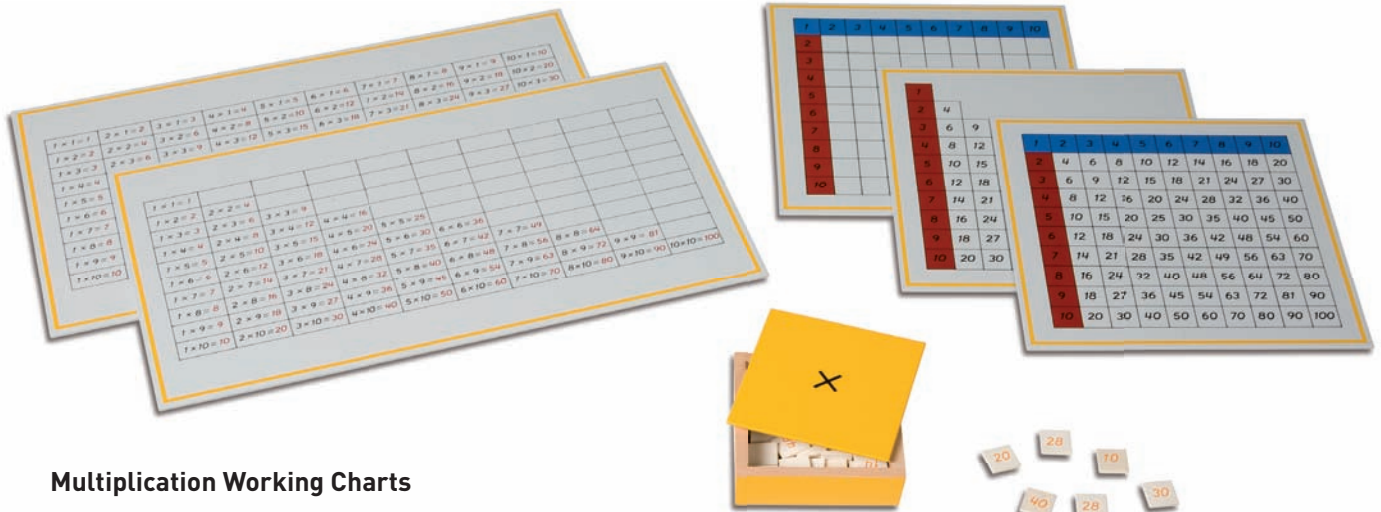

## Multiplication Working Charts

The Multiplication Working Charts aid the child in practice and memorization of the multiplication tables 1 x 1 through 10 x 10. Includes 2 control charts, 3 working charts and a box of wooden product chips.

**Item Number: 0.142.C4**



## Problem Slips: Multiplication Working Charts

3 sets of color-coded multiplication combinations (equations) slips. 1 set of combinations for each of the three Multiplication Working Charts. Each set is supplied in a separate plastic box.

**Item Number: 5.595.44**

## Working Chart Equation Paper

500 sheets with 10 rows of 5 squares printed in black on white paper. Used for memorization exercises.

**Item Number: 5.586.00**





### Multiplication Equation And Products Box

This 2-compartment box with lid contains plastic chips, 1 set with equations printed on them and 1 set with the answers to be used with the Multiplication Working Charts. All the equations and products for the multiples 1-10 are included.

**Item Number: 0.148.00**

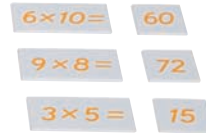

### Multiplication Tables Booklet: 1

The "traditional" multiplication tables for the numbers 1-10 with multiplier in numerical order. I.e.: Table of 1: 1 x 1 = through 1 x 10 = (40 booklets).

**Item Number: 5.595.41**



### Multiplication Tables Booklet: 2

Multiplication tables 1-10 presented with multiplier in random order. These booklets encourage further practice and repetition (40 booklets).

**Item Number: 5.595.42**

### Multiplication Tables Booklet: 3

A booklet with random multiplication equations. These booklets encourage further practice and repetition (40 booklets).

**Item Number: 5.595.43**



Multiples of numbers										table e
1	2	3	4	5	6	7	8	9	10	
11	12	13	14	15	16	17	18	19	20	
21	22	23	24	25	26	27	28	29	30	
31	32	33	34	35	36	37	38	39	40	
41	42	43	44	45	46	47	48	49	50	
51	52	53	54	55	56	57	58	59	60	
61	62	63	64	65	66	67	68	69	70	
71	72	73	74	75	76	77	78	79	80	
81	82	83	84	85	86	87	88	89	90	
91	92	93	94	95	96	97	98	99	100	

### Multiples Of Numbers Tables

2 pads (75 sheets) each of table e.

**Item Number: 5.602.00**

### Multiples Tables

1 pad (75 sheets) each: of table a (1-50) and table b (51-100). Printed in red and black. Control charts included.

**Item Number: 5.600.00**



### List Of Factors Tables

1 pad (75 sheets) each: of table c (1-50) and table c (51-100). Printed in black. Control charts table d (1-50) and table d (51-100) are included.

**Item Number: 5.601.00**

## Unit Division Board

Using the Unit Division Board, the child practices the tables of division with the dividends 1-81 and divisors 1-9. The material consists of a unit division working board, a box containing 9 green unit skittles, a green bead cup and a box of 81 wooden green beads.

**Item Number: 0.096.A0**

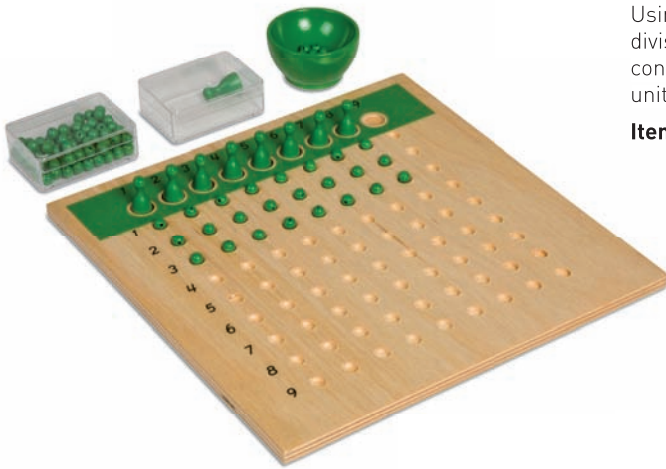

## Unit Division Board Activity Set

Additional exercises for use with the Unit Division Board. Includes: exercise cards, tab divider cards and a wooden box for storage.

**Item Number: 0.623.01**

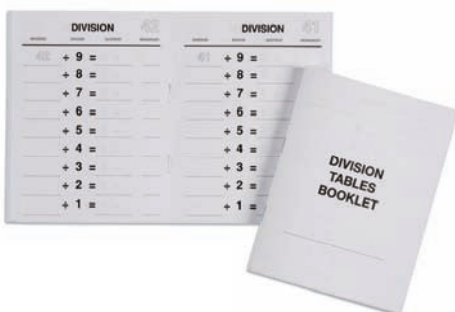
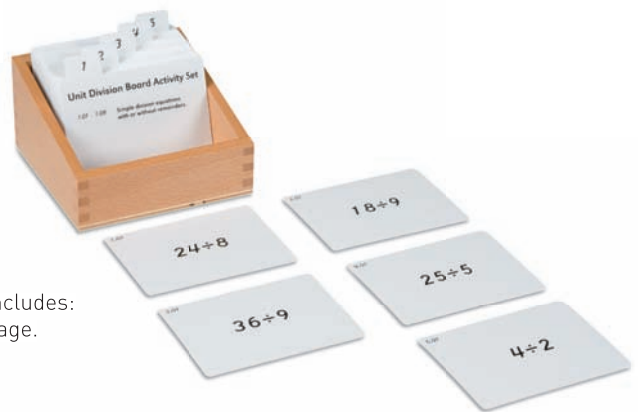

## Division Tables Booklets

81 pages of division tables from 81-1 for use with the Unit Division Board (0.096.A0). 5 booklets.

**Item Number: 5.595.51**

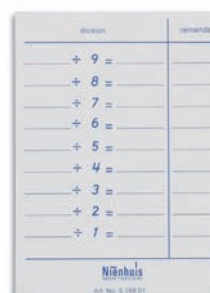

## Division Tables

The Division Tables contain the equations necessary for the exercises with the Unit Division Board.

**Item Number: 0.158.01**

**Division Working Charts**

The Division Working Charts aid the child in practice and memorization of the division combinations. Includes 2 working charts, 1 control chart and a box of wooden answer chips. The first working chart later becomes the control chart for the child to correct his work with the blind chart.

**Item Number: 0.142.D1**

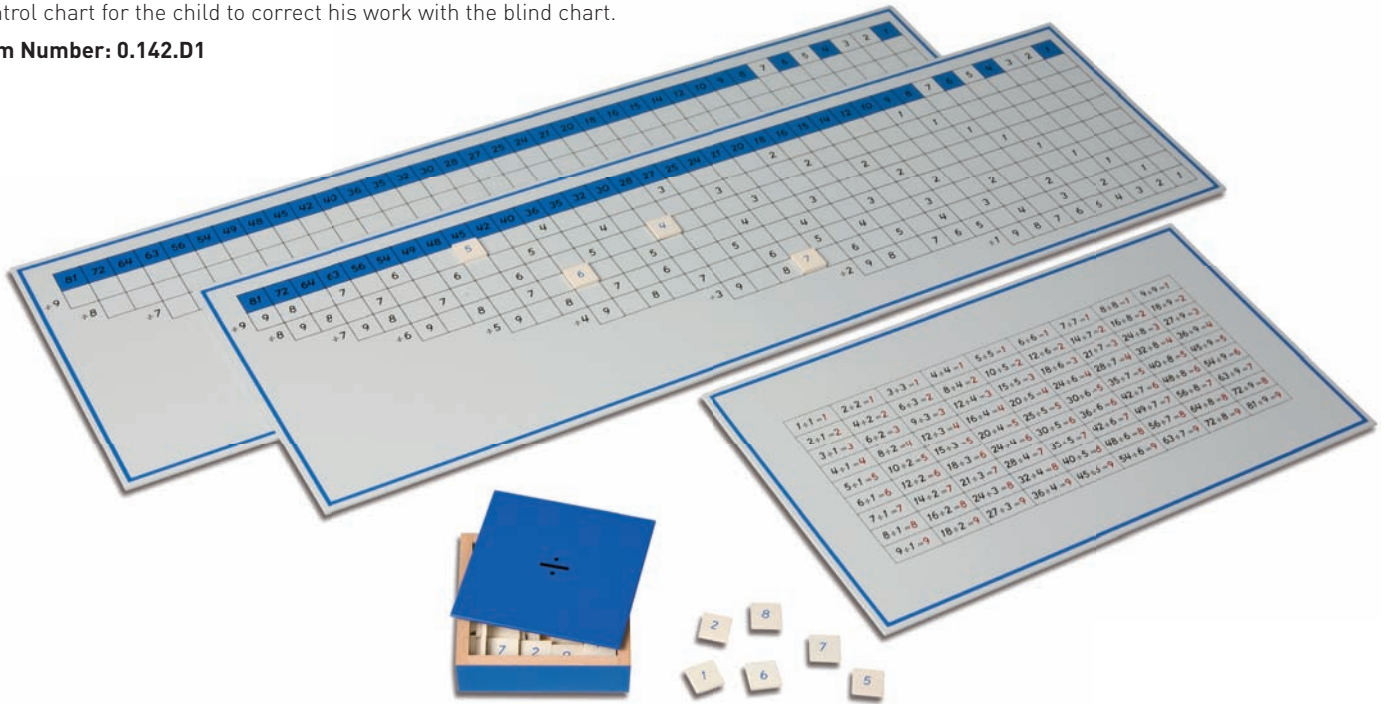

**Division Equations And Dividends Box**

This 2-compartment box with lid contains plastic chips, 1 set of all the equally divisible problems for the numbers 1-81 and 1 set of chips with the answers to be used with the Division Working Charts.

**Item Number: 0.149.01**

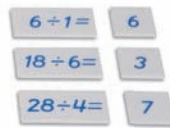

**Working Chart Equation Paper**

500 sheets with 10 rows of 5 squares printed in black on white paper. Used for memorization exercises.

**Item Number: 5.586.00**



**Problem Slips: Division Working Charts**

2 sets of color-coded unit division combinations (equations) slips. 1 set of combinations for use with each of the two Division Working Charts. Each set is supplied in a separate plastic box.

**Item Number: 5.595.54**





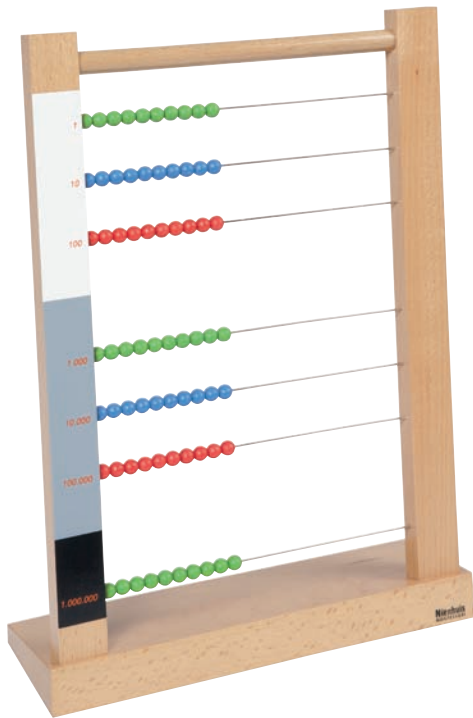

### Large Bead Frame

The Large Bead Frame forms the bridge to abstraction for the decimal system exercise of multiplication.

**Item Number: 0.094.00**



### Large Bead Frame Activity Set

Additional exercises for use with the Large Bead Frame. Includes: exercise cards, tab divider cards and a wooden box for storage.

**Item Number: 0.605.01**

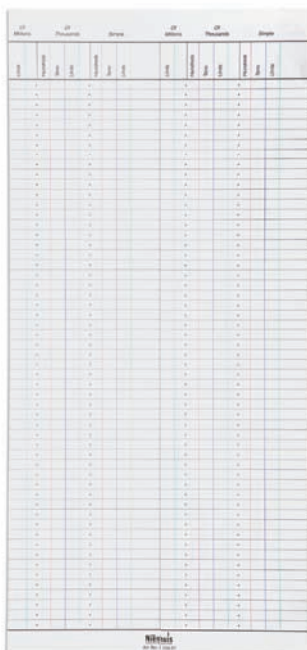

### Large Bead Frame Paper: (50 sheets)

Specially designed color-coded, lined paper for use with the Large Bead Frame.

**Item Number: 0.154.01**

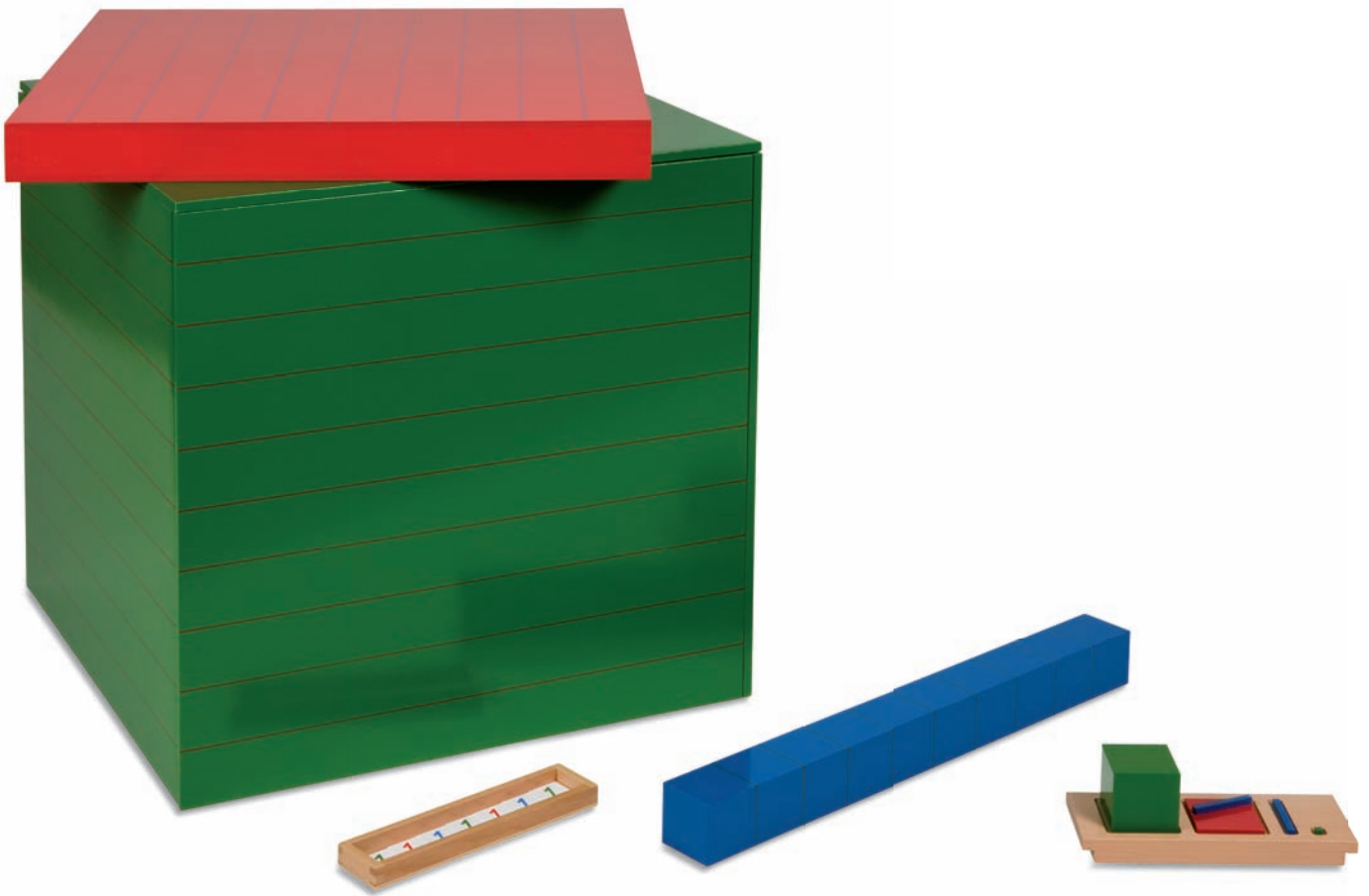

## Geometric Hierarchy Of Numbers

This material is used to represent in geometric form the hierarchy of numbers for: 1, 10, 100, 1000, 10,000, 100,000 and 1,000,000. The precise nature of these materials makes it possible to compare by size the decimal categories, visualize through the color-coded system, the concept of decimal value and the families of number. A wooden tray for presentation of 1, 10, 100 and 1000 is included (number cards not included).

**Item Number: 0.132.A0**



## Geometric Hierarchy Number Cards

A set of number cards for each of the numerals 1, 10, 100, 1000, 10,000, 100,000 and 1,000,000. A wooden storage box is included.

**Item Number: 0.132.B0**

### Long Division

The Long Division material forms the bridge to abstraction for the decimal system exercises of division. The set consists of 4 color-coded division boards and a wooden tray that holds the 7 racks of tubes with beads, 7 cups and 36 skittles.

**Item Number: 0.095.00**

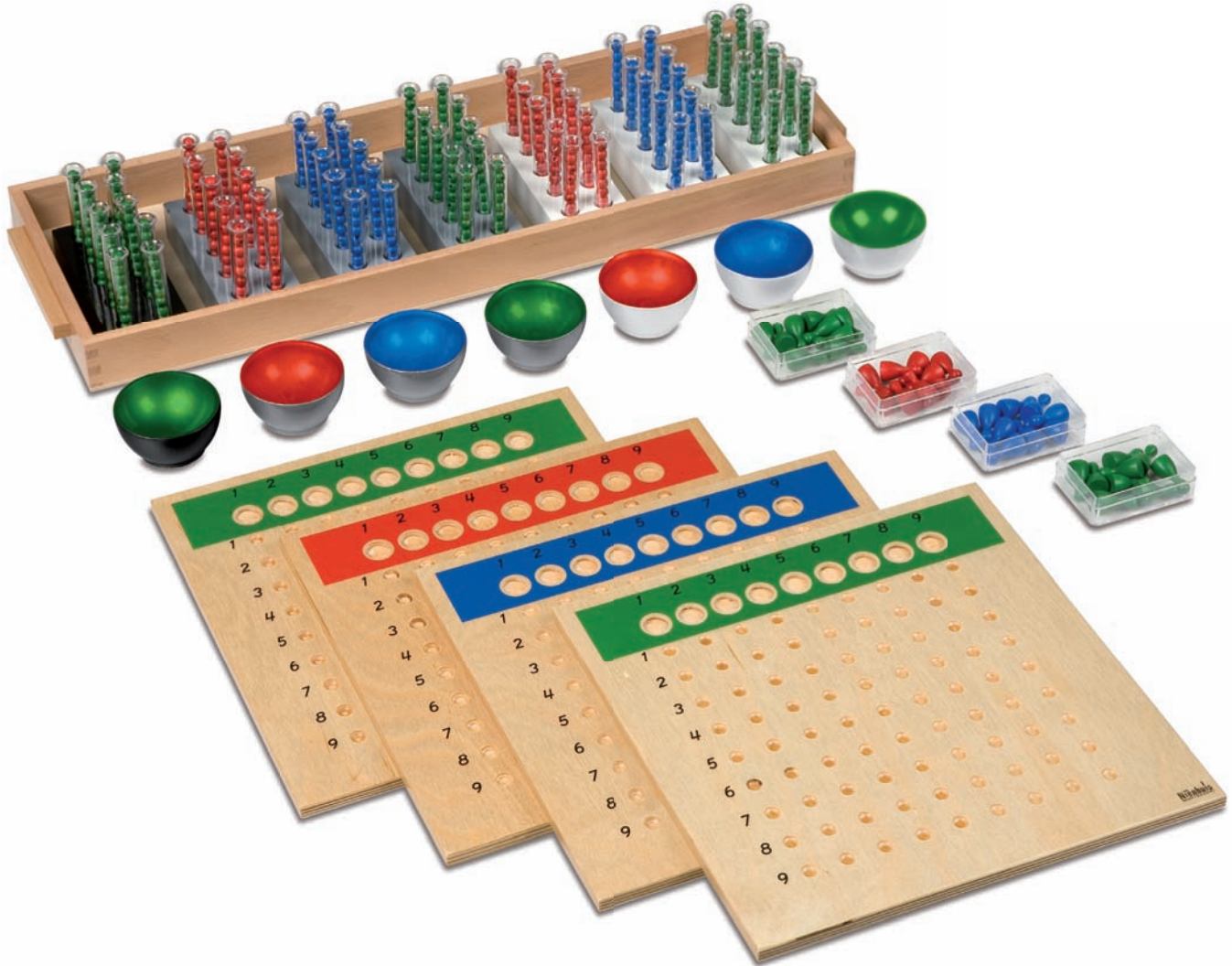

### Long Division Activity Set

Additional exercises for use with the Long Division material. Includes: exercise cards, tab divider cards and a wooden box for storage.

**Item Number: 0.607.01**

## Small Skittles: (100)

Includes 50 green, 25 blue and 25 red small skittles.

Item Number: 0.097.00



## Large Skittles: (27)

Includes 9 green, 9 red and 9 blue large skittles.

Item Number: 0.098.00



## Blue Beads: (100)

Item Number: 0.095.B1



## Green Beads: (100)

Item Number: 0.095.B0



## Red Beads: (100)

Item Number: 0.095.B2





### Checker Board

The Checker Board is used for short and long multiplication with the hierarchies in the decimal system up to 100,000,000.

**Item Number: 0.137.01**



### Checker Board Beads

**Item Number: 0.138.00** - Connected Beads Nylon

**Item Number: 0.138.G0** - Individual Beads Glass (pictured)

**Item Number: 0.138.M0** - Individual Beads Nylon

## Number Tiles

This set of wooden color-coded number tiles is designed for use with the Checker Board, Decimal Checker Board and the Flat Bead Frame.

**Item Number: 0.138.B0**



## Box With Grey And White Number Tiles

This advanced set of wooden color-coded number tiles is designed for use with the Checker Board, Decimal Checker Board, the Flat Bead Frame, the Bead Material and various other math exercises. The numerals on the tiles are printed in black, instead of the colors used in the hierarchy of the decimal system, thus demonstrating the move from one category to another more clearly.

**Item Number: 0.099.50**



## Checker Board Activity Set

Additional exercises for use with the Checker Board. Includes: exercise cards, tab divider cards and a wooden box for storage.

**Item Number: 0.602.01**





### Decanomial Bead Bar Box

This set of bead bars is used for building the decanomial. The multiplication tables from 1 - 10 may be constructed in geometric form using the beads. Includes 55 of each of the colored bead bars from 1-10 and a wooden box for storage.

**Item Number: 0.190.00 - Connected Beads Nylon**

**Item Number: 0.190.G0 - Individual Beads Glass (pictured)**

**Item Number: 0.190.M0 - Individual Beads Nylon**

### Decanomial Paper

10 printed forms (printed in actual size) of the decanomial with black bead outlines.

**Item Number: 0.191.00**

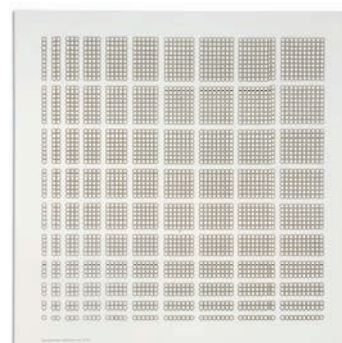

### Table Of Pythagoras

With the table of pythagoras, the child places the squares and rectangles in order by size and color to complete the square of the decanomial. The material consists of a 10 compartment beechwood box for storing the sets of color-coded plastic squares and rectangles.

**Item Number: 0.186.00**





## Flat Bead Frame

The Flat Bead Frame activities are the final step in the passage to abstraction with multiplication. Consists of a beechwood frame with 9 columns of movable golden glass beads.

**Item Number: 0.099.00**

## Flat Bead Frame Activity Set

Additional exercises for use with the Flat Bead Frame. Includes: exercise cards, tab divider cards and a wooden box for storage.

**Item Number: 0.608.01**



## Box With Grey And White Number Tiles

This advanced set of wooden color-coded number tiles is designed for use with the Checker Board, Decimal Checker Board, the Flat Bead Frame, the Bead Material and various other math exercises. The numerals on the tiles are printed in black, instead of the colors used in the hierarchy of the decimal system, thus demonstrating the move from one category to another more clearly.

**Item Number: 0.099.50**





### Bank Game

The Bank Game reinforces the concept of long multiplication. The children assume different roles as they perform the game exercises. Includes plastic number cards and role designator cards and a specially designed box with lid.

**Item Number: 0.073.00**

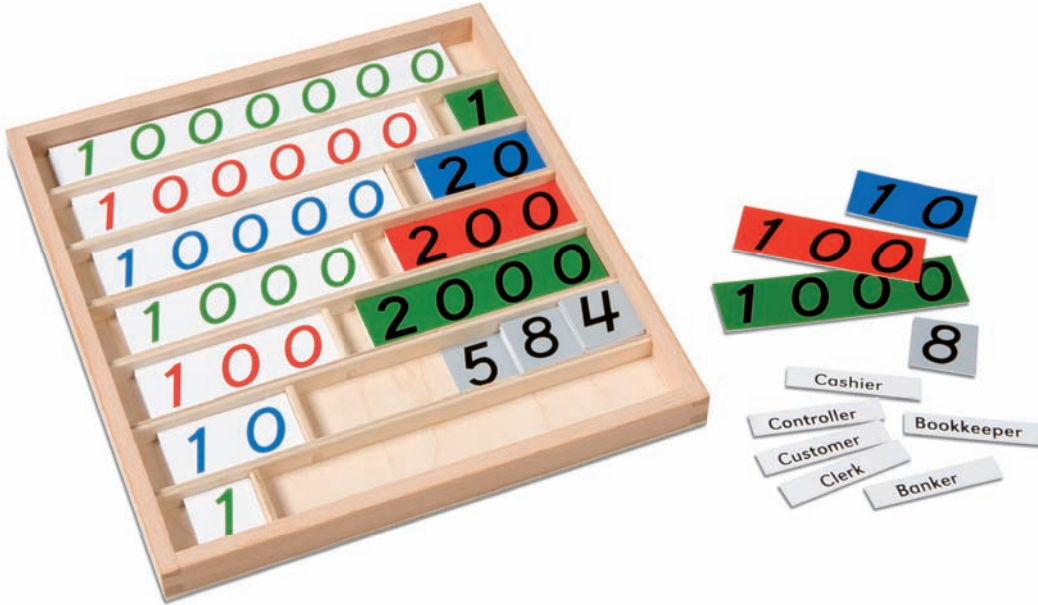

### Bank Game Activity Set

Additional exercises for use with the Bank Game. Includes: exercise cards, tab divider cards and a wooden box for storage.

**Item Number: 0.603.01**



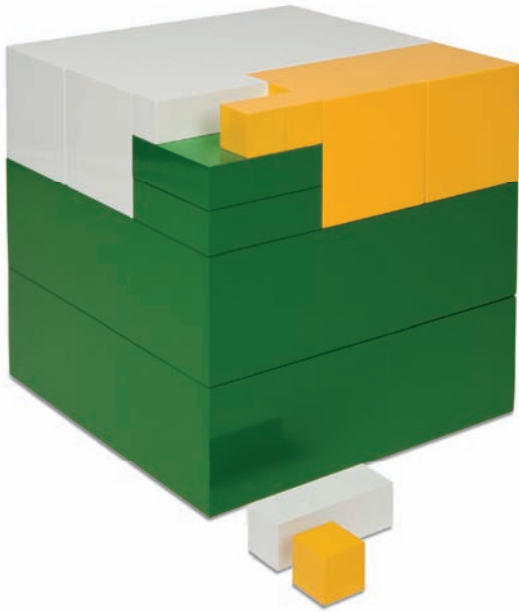

### Power Of Three Cube

This material demonstrates the Power Of Three by its component parts of cubes and prisms.

**Item Number: 0.129.01**

**One Yellow Cube: (27 x 27 x 27 cm)**

**Item Number: 0.129.02**

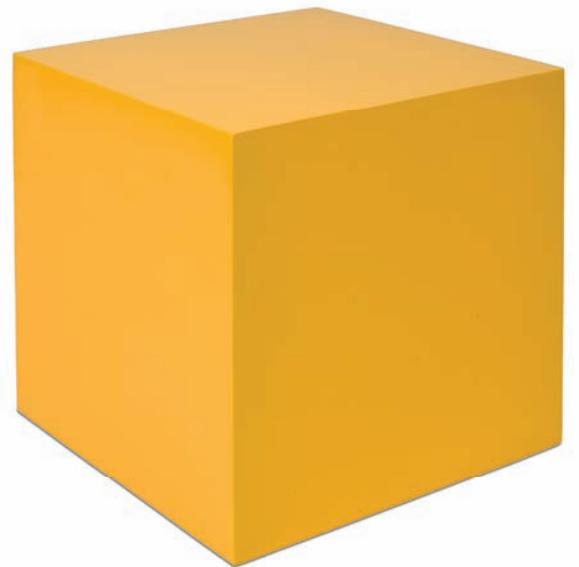

### Power Of Two Cube

This material demonstrates the Power Of Two by its component parts of cubes and prisms, each a progression of squaring the previous piece. It is contained in a hinged wooden box with lid.

**Item Number: 0.130.00**

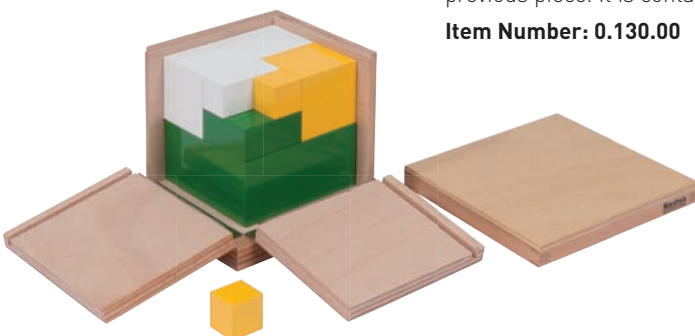

### Algebraic Peg Board

This material is used for demonstrating the mechanism of finding the square root.

**Item Number: 0.135.00**

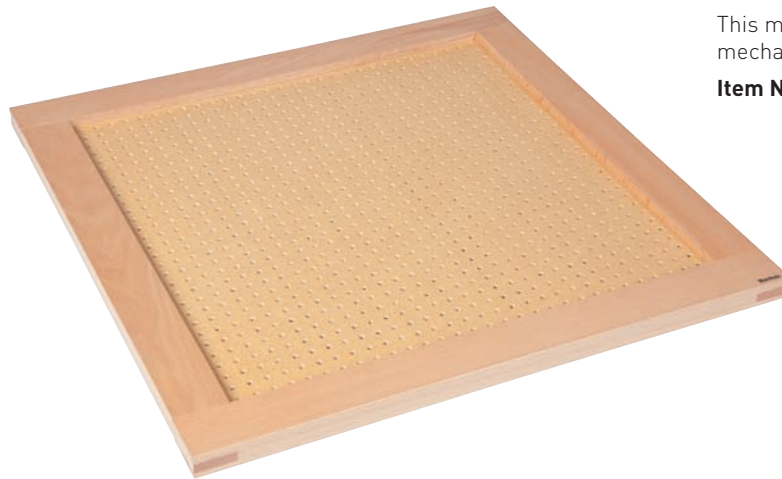

### Pegs For The Algebraic Peg Board

This set consists of color-coded pegs and cups stored in a wooden box with lid. For use with the Algebraic Peg Board.

**Item Number: 0.136.00**



### Algebraic Peg Board Activity Set: 1

Additional exercises for use with the Algebraic Peg Board. Includes: exercise cards, tab divider cards and a wooden box for storage.

**Item Number: 0.613.01**

## Algebraic Peg Board Activity Set: 2

Additional exercises for use with the Algebraic Peg Board. Includes: exercise cards, tab divider cards and a wooden box for storage.

**Item Number: 0.614.01**



## Small Square Root Board

The Small Square Root Board is used by the children to build squares and to extract square roots. The wooden board contains 225 indentations for working square roots. Included with the board is a box of 100 each green, blue and red beads.

**Item Number: 0.133.00**

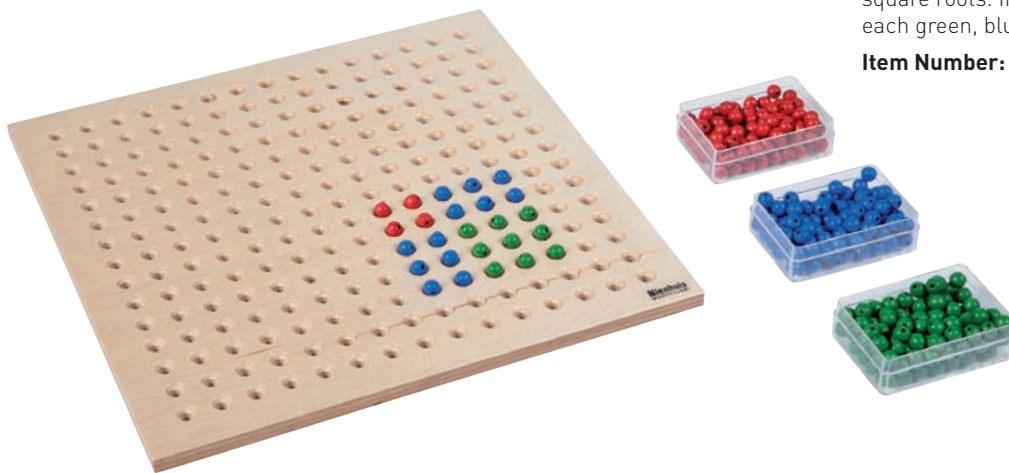

## Patterns For Square Root

These patterns serve as guides when extracting the square root on the Algebraic Peg Board. The material consists of 4 plastic cards with silk-screened square root patterns in the 3 hierarchical colors.

**Item Number: 0.134.01**



### Binomial Cube

The Binomial Cube is a concrete representation of the algebraic formula  $(a + b)^3$ . The factors of the equation are represented by cubes and prisms. The elementary Montessori child uses the Binomial Cube as an activity of algebraic exploration. Contained in a hinged wooden box with lid.

**Item Number: 0.131.00**

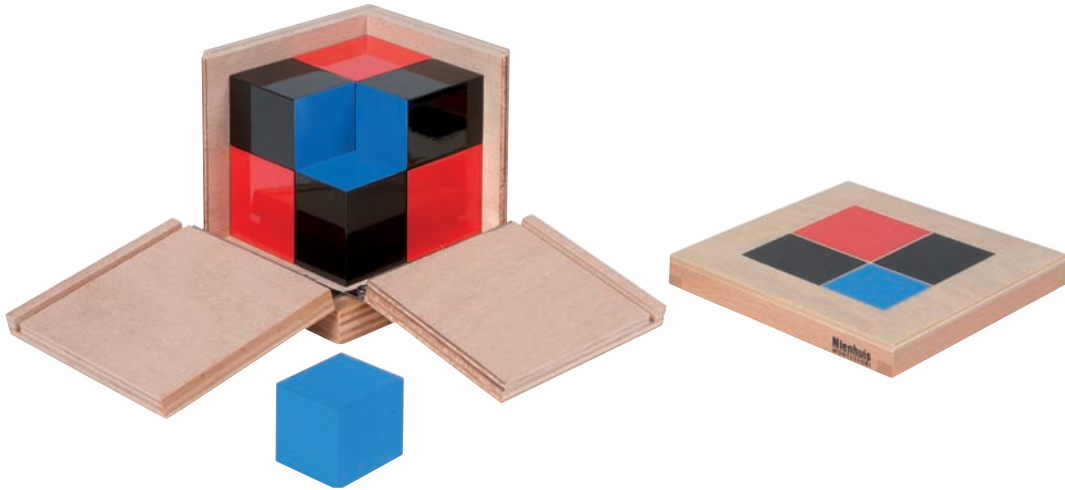

### Trinomial Cube

The Trinomial Cube is a concrete representation of the algebraic formula  $(a + b + c)^3$ . The factors of the equation are represented by cubes and prisms. The elementary Montessori child uses the Trinomial Cube as an activity of algebraic exploration. Contained in a hinged wooden box with lid.

**Item Number: 0.132.00**



## Arithmetic Trinomial Cube

This cube represents the equation  $(a + b + c)^3$  in concrete form and differs from the Trinomial Cube in that the component pieces are color-coded to represent hierarchical values from 1 unit to 1 million. This makes it possible for the child to equate an arithmetical value to each of the cubes and prisms. Contained in a hinged wooden box with lid.

**Item Number: 0.187.00**

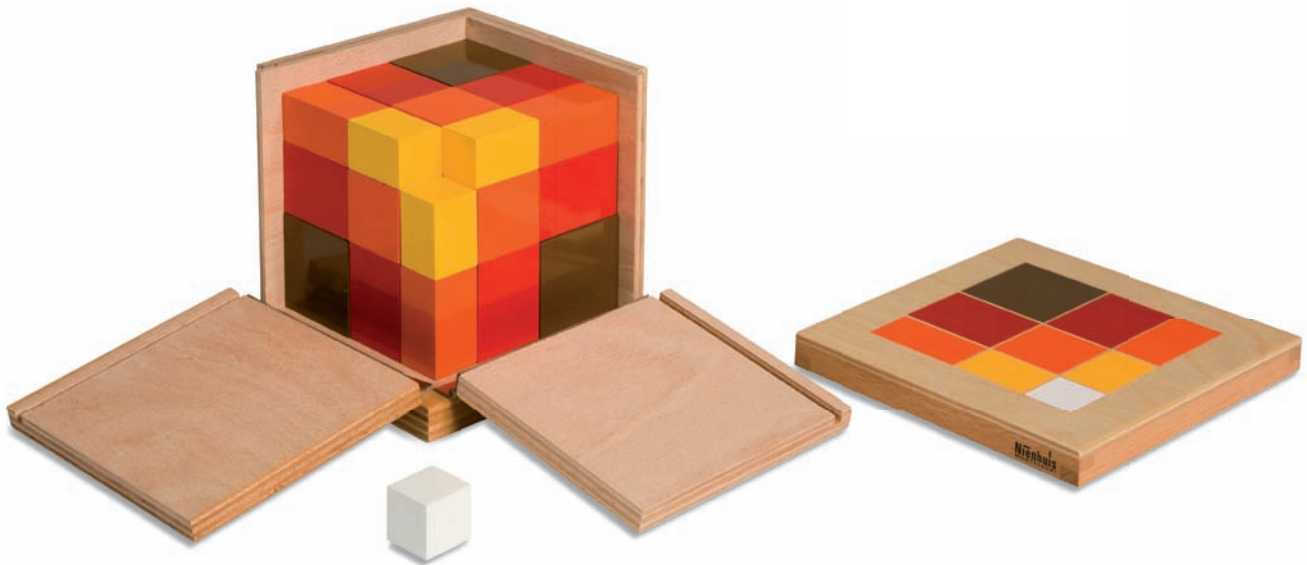

## Algebraic Binomial Cube

This cube for  $(a + b)^3$  provides the basis necessary for the sensorial construction of higher powers of the same binomial:  $(a + b)^4$  and  $(a + b)^5$ . Contained in a hinged wooden box with lid.

**Item Number: 0.272.00**



### Cubing Material

The Cubing Material is used to construct cubes and discover relationships between their component parts. These exercises prepare the child for abstract analysis of the binomial and trinomial cubes along with cube roots. The material consists of 1 cube and 27 squares for each of the numbers from 1 - 9. Includes a beechwood tray with lid.

**Item Number: 0.189.00**



### Colored Counting Bars

The Colored Counting Bars correspond in length and color to the Cubing Material. This material is a transition between the bead bars and the solid material. The set consists of 20 bars of each quantity 1-10, stored in a wooden box with 10 compartments.

**Item Number: 0.193.00**



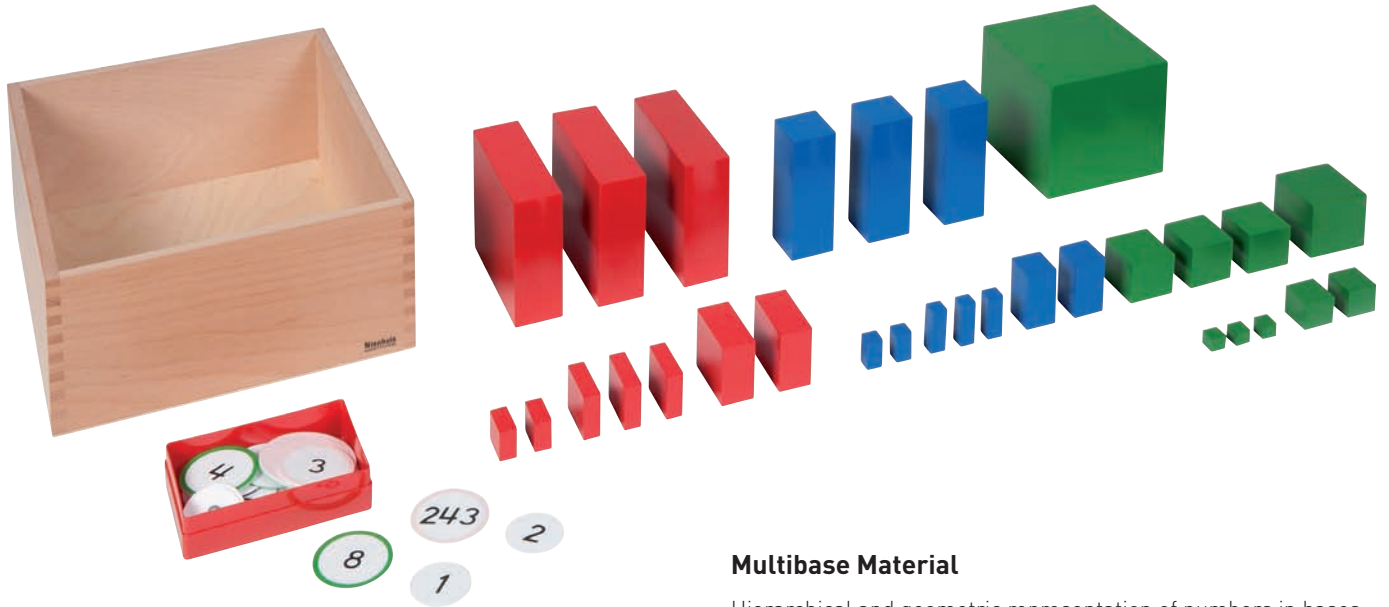

### Multibase Material

Hierarchical and geometric representation of numbers in bases 2 and 3 for counting forwards and backwards, and for converting numbers from base 10 into these bases and vice versa (chart ordered separately).

**Item Number: 0.270.00**

### Chart For Multibase Material

**Item Number: 0.271.01**

	VALUE IN BASE 10							
BASE								
POWERS	6 <sup>3</sup>	5 <sup>3</sup>	4 <sup>3</sup>	3 <sup>3</sup>	2 <sup>3</sup>	1 <sup>3</sup>	0 <sup>3</sup>	0 <sup>3</sup>
NUMBER	0	0	0	0	0	0	0	0
MATERIAL								



### Decimal Stamp Game

The number tiles are printed with decimal fractions from 1 - 0.000009. For recognizing and labeling decimal number combinations and performing operations of addition, subtraction and multiplication with decimal numbers.

**Item Number: 0.183.01**



## Decimal Fraction Exercise

Used for various decimal operations and with the Decimal Fraction Board, this material introduces decimal quantity and symbol. The material consists of a wooden box containing color-coded cubes to represent hierarchical values. Included is a complete set of decimal number cards from 1- 0.00009.

**Item Number: 0.139.01**



## Decimal Fraction Exercise Activity Set

Additional exercises for use with the Decimal Fraction Exercise. Includes: exercise cards, tab divider cards and a wooden box for storage.

**Item Number: 0.618.01**

## Decimal Fraction Board

The Decimal Fraction Board is used for the introduction of decimal number formation and for performing the operations of addition, subtraction and multiplication with decimal and whole numbers.

**Item Number: 0.140.01**

### Decimal Checker Board

This material allows the child to work short and long multiplication problems of whole and decimal numbers. The Decimal Checker Board is made up of 49 squares colored in the hierarchical shades of green, blue and red. The diagonal squares represent the hierarchies from millions to millionths and differentiate decimals from whole numbers. (Colored Bead Bars and specially designed number tiles are needed to perform the exercises: 0.138.00, 0.138.M0 or 0.138.G0, and 0.138.B0).

**Item Number: 0.182.01**

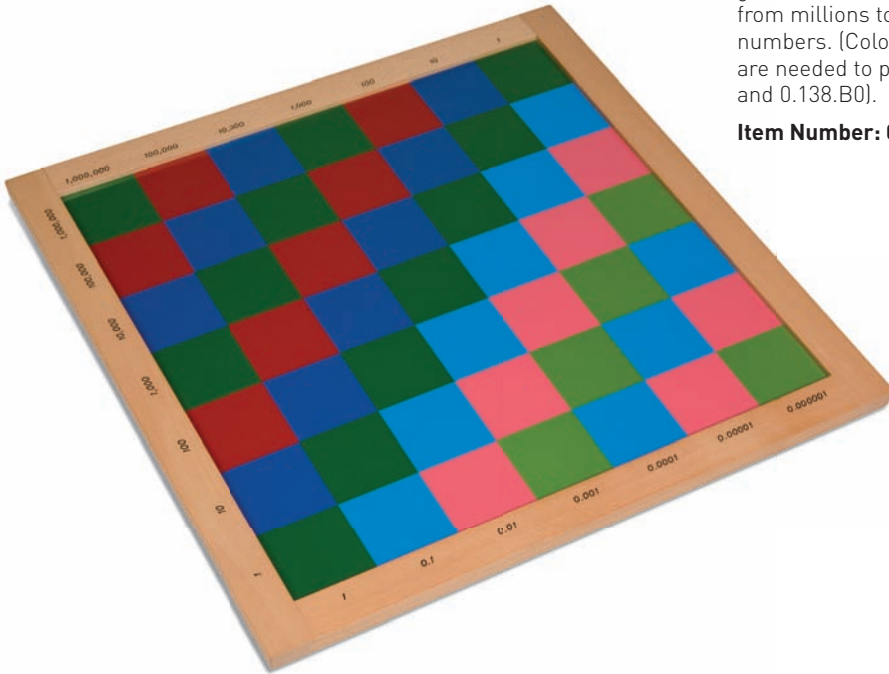

### Checker Board Beads

Contains 20 of each Colored Bead Bars 1 through 9 in a wooden box with lid. These beads along with the tile material (0.138.B0 and 0.099.50) are component parts necessary to do the Checker Board activities.

**Item Number: 0.138.00 - Connected Beads Nylon**

**Item Number: 0.138.G0 - Individual Beads Glass (pictured)**

**Item Number: 0.138.M0 - Individual Beads Nylon**





### **Geometric Stick Material**

The Geometric Stick Material is used in the elementary classroom for the study of lines, the measurement of angles, and the construction and analysis of plane geometric shapes. Consists of a series of color-coded sticks, plastic curves, a plastic measuring angle, a plumb line, tacks and brad fasteners, all stored in a compartmentalized wooden box with lid.

**Item Number: 0.194.00**

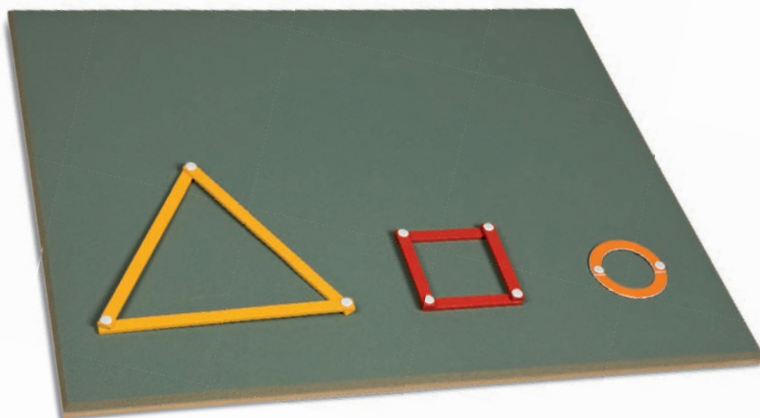

### **Large Working Board For The Geometric Stick Material**

A large working board made of 'self-healing' material for use with the Geometric Stick Material.

**Item Number: 0.194.A0**

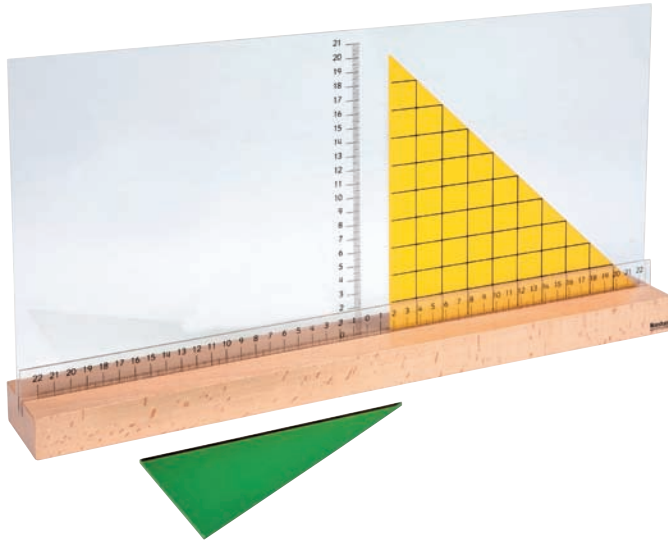

## Stand For Height

A stand for plane geometric form exploration that facilitates in the measurement of height. For use with the Constructive Triangles and the Yellow Triangles For Area. Scale is in centimeters.

**Item Number: 0.126.00**

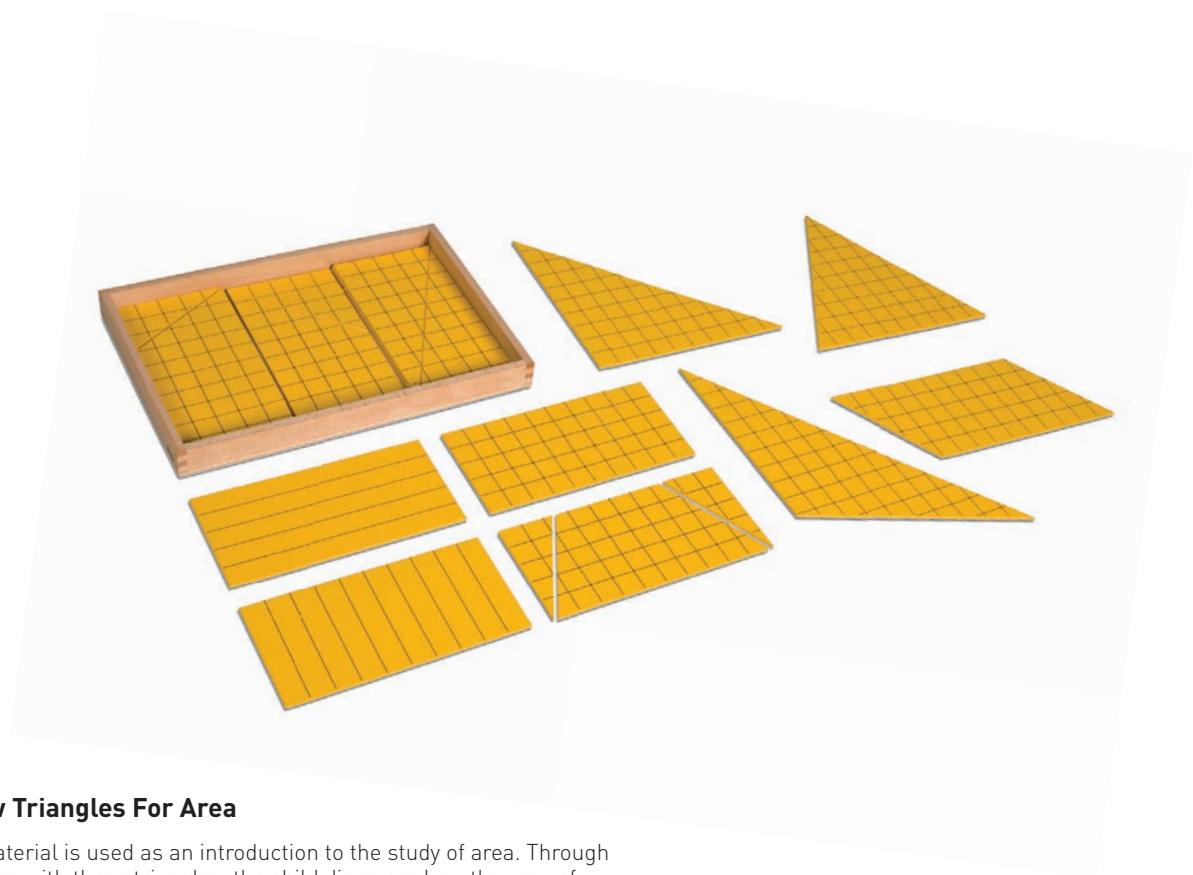

## Yellow Triangles For Area

This material is used as an introduction to the study of area. Through exercises with these triangles, the child discovers how the area of a triangle is derived. The material contains 20 yellow, square ruled figures for the exercises of area stored in a beechwood box with lid.

**Item Number: 0.127.00**

### Large Fraction Skittles

The Large Fraction Skittles represent divisors of whole,  $\frac{1}{2}$ ,  $\frac{1}{3}$ , and  $\frac{1}{4}$  and are used with the Fraction Circles to work equations in division.

**Item Number: 0.113.00**



### Skittle Stand

A hardwood stand for storing and carrying the Large Fraction Skittles.

**Item Number: 0.113.A0**

### Instrument For The Measurement Of Angles

This material is used with the Fraction Circles to demonstrate how angles are measured in degrees. The Instrument For The Measurement Of Angles is a thick metal plate calibrated in 360 degrees with a recessed circle for positioning a fraction piece to be measured.

**Item Number: 0.124.00**

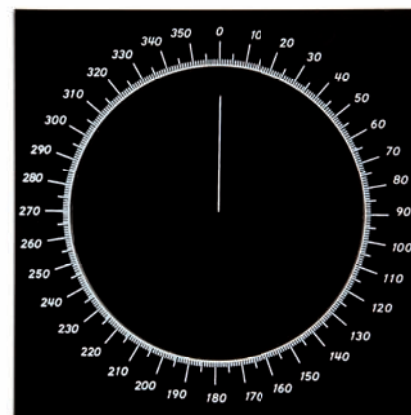

### The Centesimal Frame

This material is used with the Fraction Circles to demonstrate how fractions may be reduced to decimal fractions. The Centesimal Frame is a thick metal plate with a recessed circle for positioning the fraction piece to be converted to a decimal, and is calibrated from 0 to 100.

**Item Number: 0.125.00**

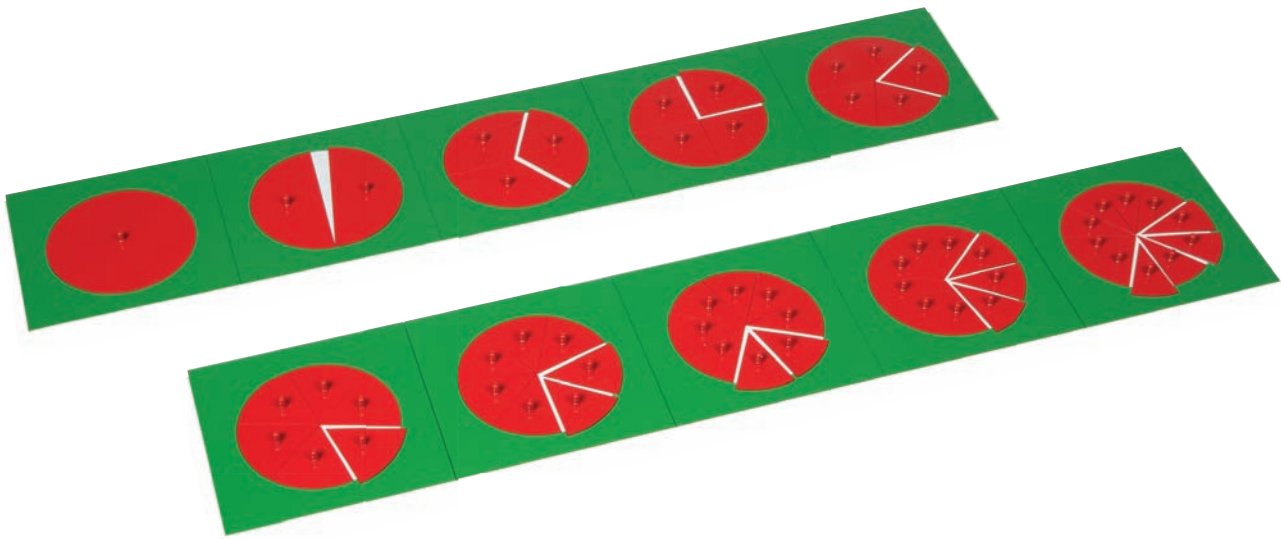

**Fraction Circles**

Fraction Circles introduce the child to the concept of fractions. The child is introduced to all aspects of fraction work, i.e., correct terminology, equivalency, arithmetic functions, conversion to decimals, measurement of angles, etc.

**Item Number: 0.114.00**

**Fraction Circles Stands: (2)**

2 stands designed to each hold five Fraction Circles for storing and carrying.

**Item Number: 0.114.A0**

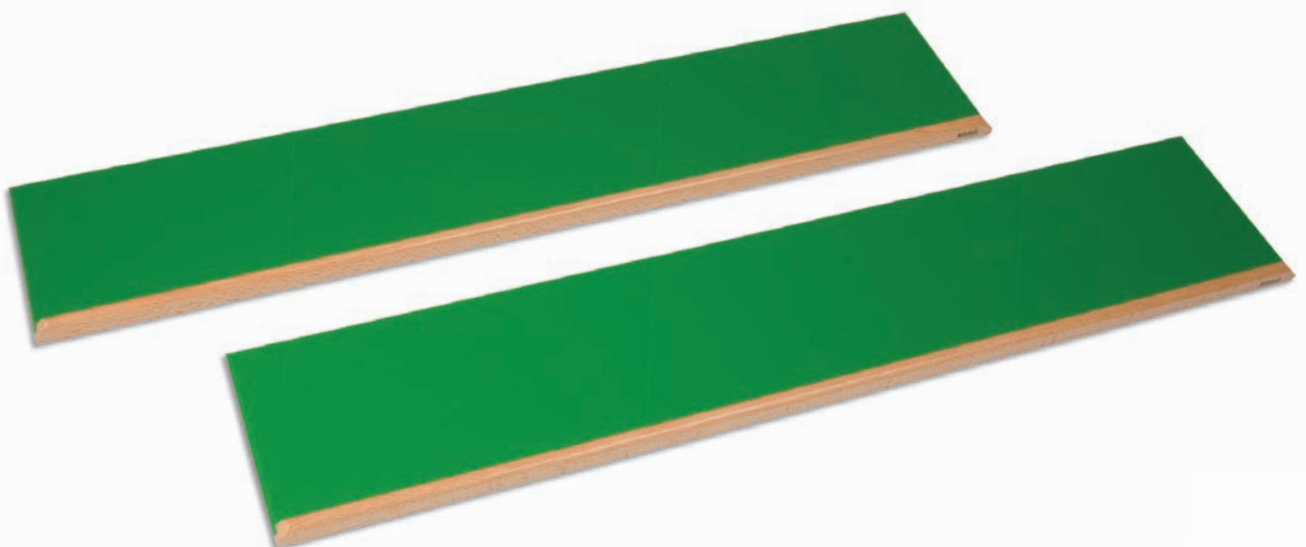



### Cut-Out Labeled Fraction Circles

The Cut-Out Labeled Fraction Circles are used by the child as an extension of his work with the Fraction Circles. The plastic set includes 10 whole circles and 5 sets of labeled fraction pieces for each of the values from halves to tenths.

**Item Number: 0.185.00**

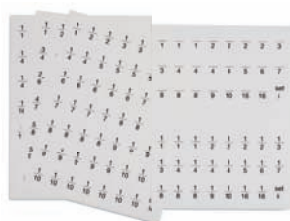

### Fraction Labels

208 labels printed on white card stock. 6 sets for exercises including labeling the fraction circles.

**Item Number: 5.605.00**



### Fraction Equivalent Research Sheets

50 each: Fraction Equivalent Research Sheets page 1, page 2 and reduction of fractions to their lowest terms. Includes 3 control charts.

**Item Number: 5.607.10**



### Fraction Problems: Series 1

672 fraction equations printed on 28 sheets to be cut apart. 7 sheets each for addition and subtraction of fractions with like denominators, and multiplication and division of fractions by a whole number.

**Item Number: 5.606.00**



### Fractions Activity Set: 1

Additional exercises for use with The Cut-Out Fractions. Includes: exercise cards, divider tabs and a wooden box for storage.

**Item Number: 0.615.01**



### Fractions Activity Set: 2

Additional exercises for use with The Cut-Out Fractions. Includes: exercise cards, divider tabs and a wooden box for storage.

**Item Number: 0.616.01**



### Fractions Activity Set: 3

Additional exercises for use with The Cut-Out Fractions. Includes: exercise cards, divider tabs and a wooden box for storage.

**Item Number: 0.617.01**

### Metal Squares: 9 Plates

This material is used for geometry, specifically exercises of equivalent, identical and similar figures. The set consists of 9 green metal frames with bottoms, 1 set of insets divided into squares and rectangles and 1 set of insets divided into triangles (this material is also used for small metal inset work, 'linear geometric design.').

**Item Number: 0.115.00**

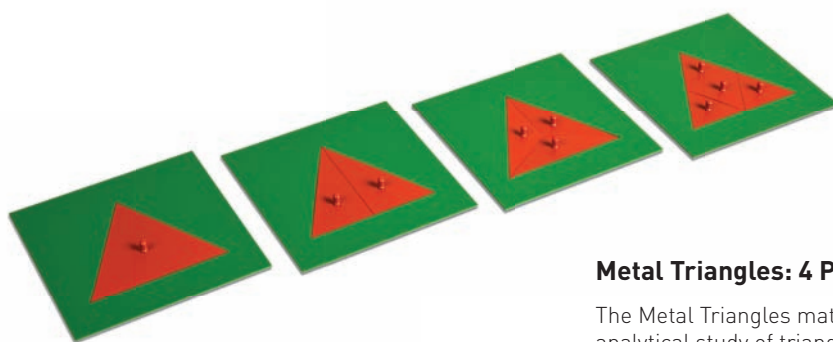
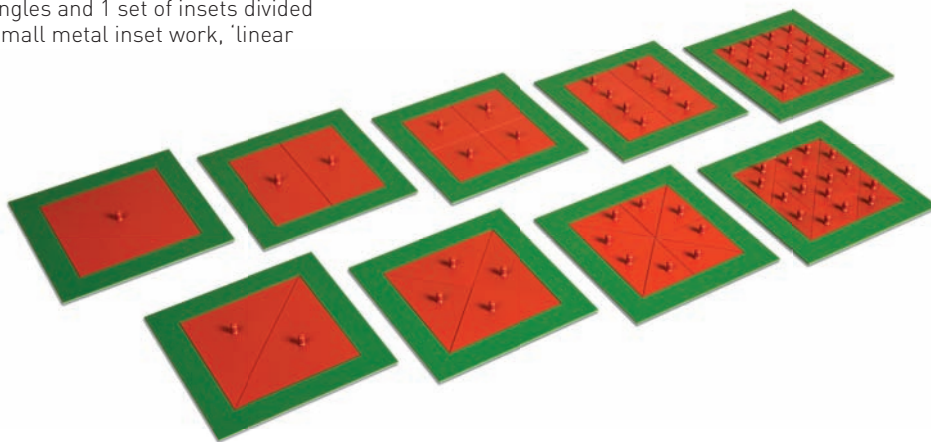

### Metal Triangles: 4 Plates

The Metal Triangles material allows the child to make an analytical study of triangles. The set consists of 4 metal frames with bottoms. The insets are equilateral triangles divided into 1, 1/2, 1/3 and 1/4.

**Item Number: 0.116.00**

### Inscribed And Concentric Figures: Metal

This material is used for the study of inscribed and concentric figures. The material consists of 9 green metal frames with bottoms and red insets with 1 set of 5 circles decreasing in diameter and 1 set of 4 squares decreasing in length and width.

**Item Number: 0.118.00**

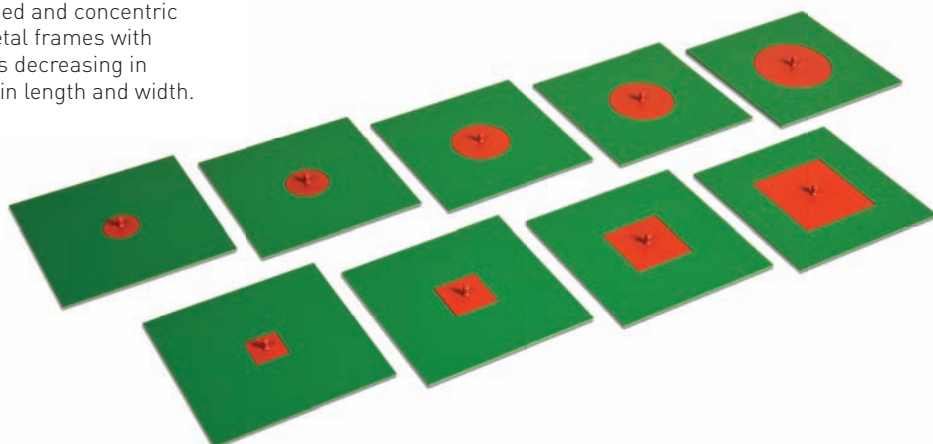

## Small Quatrefoil

Item Number: 0.117.B0



## Small Trapezoid

Item Number: 0.117.A0

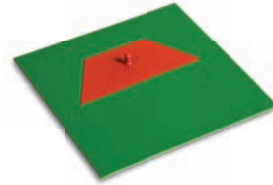

## Small Triangle

Item Number: 0.117.00

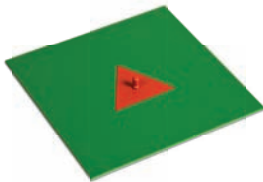

## Triangle Inscribed In Circle

Item Number: 0.119.00

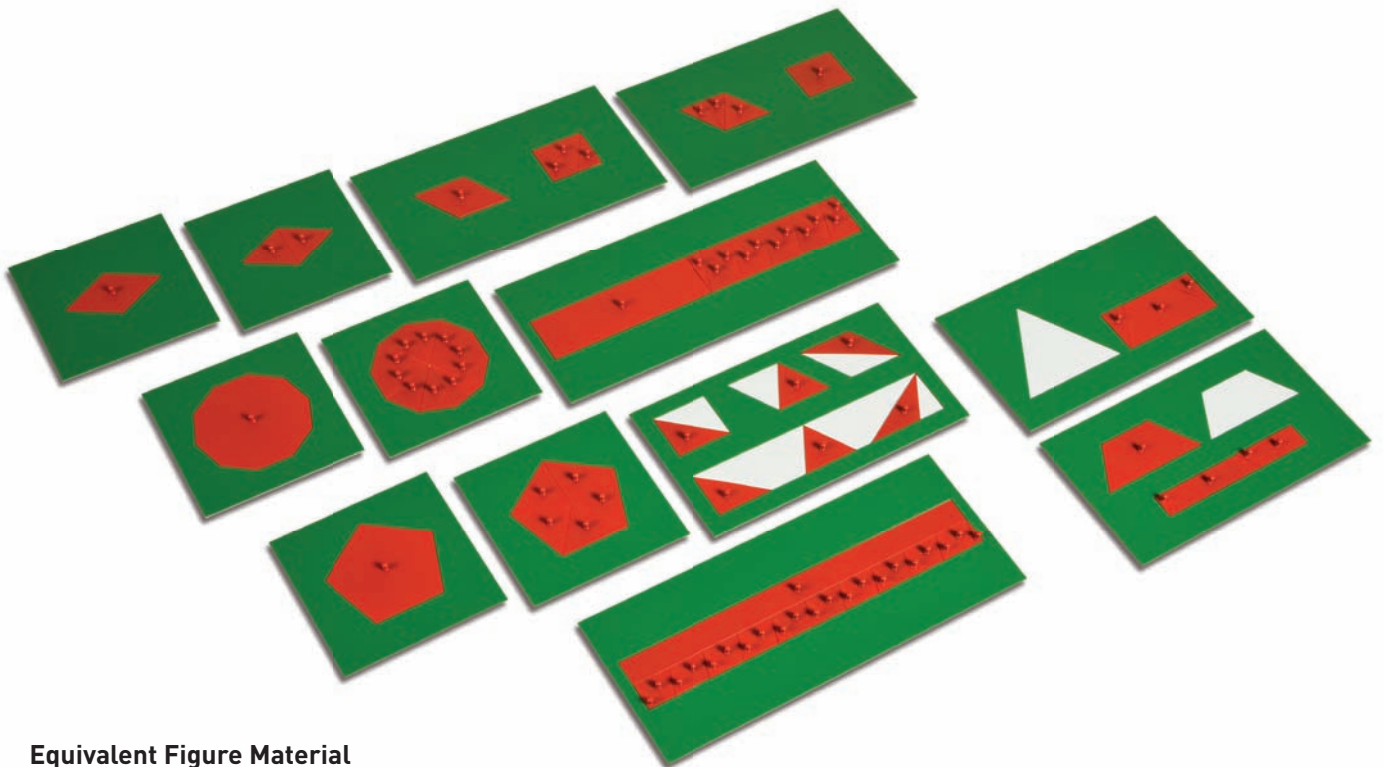
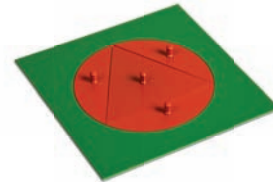

## Equivalent Figure Material

The Equivalent Figure Material provides experience in studying the relationship of equivalent figures that leads to the discovery of area and theorems. The material consists of 13 green metal frames with bottoms and red insets.

Item Number: 0.122.00

### Theorem Of Pythagoras

This set of material represents three cases of the Theorem Of Pythagoras. In the first, 2 sides of the triangle are equal; in the second, the sides of the triangle are in the proportion of 3: 4: 5; and in the third, the general case (the Euclidean demonstration) is shown. The material consists of 3 green metal plates with bottoms and blue, red, yellow and white inset pieces.

**Item Number: 0.123.00**

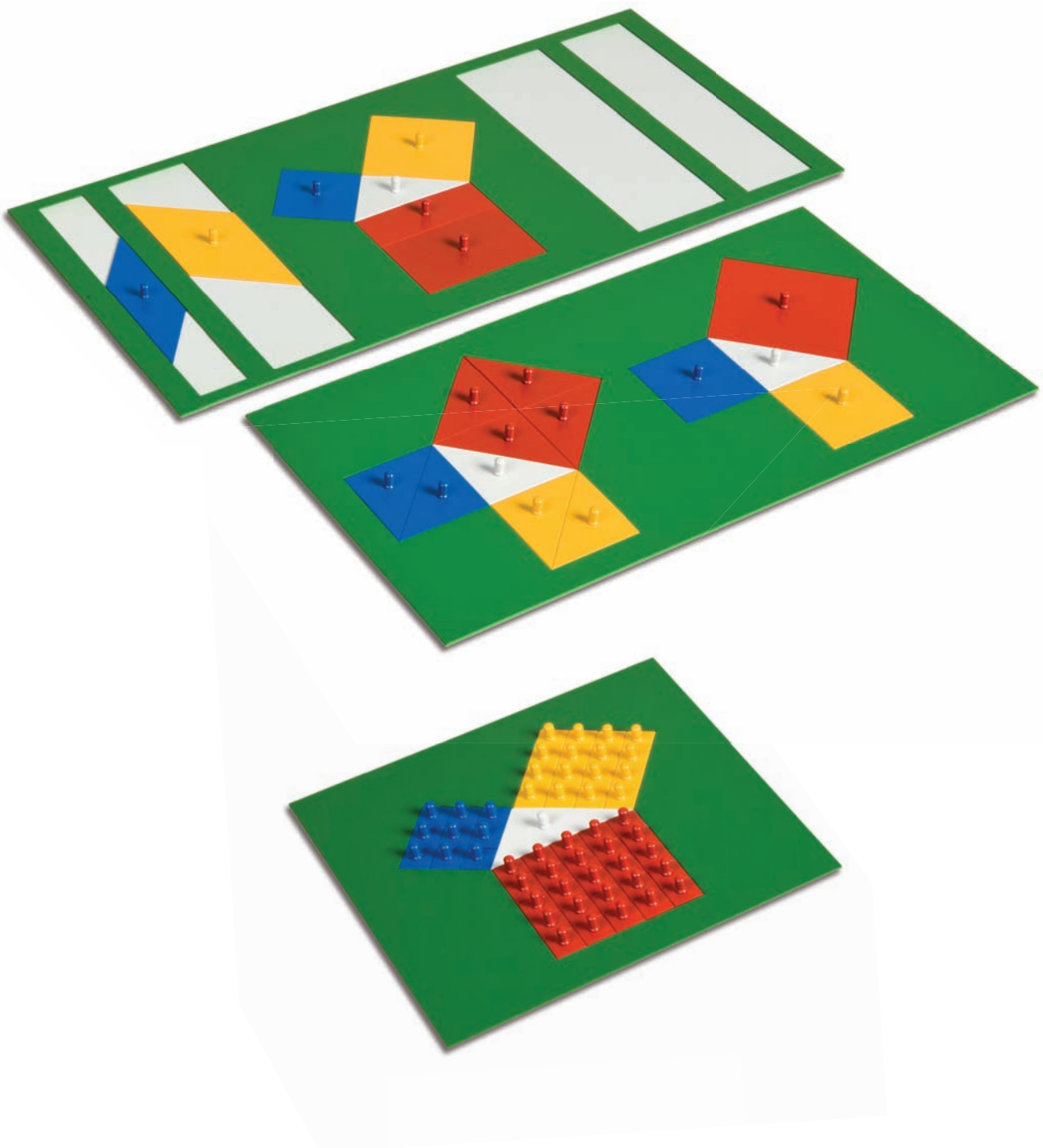

## Fraction Cabinet

This beech plywood cabinet is specially designed to hold the complete set of Fraction Material (0.114.00 through 0.125.00). This cabinet has 14 drawers, and measures 49 x 34 x 41 cm (Fraction Material not included).

**Item Number: 1.765.00**





**Volume Box With 250 Cubes**

This material is used for calculation of volume and with the Cubing Material. The wooden box with lid has a hinged side and contains 250 wooden, 2 cm cubes.

**Item Number: 0.188.A0**

**Volume Box With 1000 Cubes**

This material is used for calculation of volume and with the Cubing Material. The wooden box with lid has a hinged side and contains 1000 wooden, 1 cm cubes.

**Item Number: 0.192.00**



**Five Yellow Prisms In Wooden Box**

The Five Yellow Prisms are used in calculating the volume of a rectangular prism. The material consists of 5 wooden rectangular prisms (20 x 10 x 2 cm) painted yellow and ruled in lines and squares. The prisms are stored in a hinged wooden box with lid.

**Item Number: 0.188.B1**

## Box With Prisms For Brown Stair

Box with 19 wooden prisms (1 x 1 x 20 cm) in a natural wood finish. Used to compare and calculate the volume of the prisms of the Brown Stair.

**Item Number: 0.025.20**



## Box With Cubes For Pink Tower

A box with 273 wooden cubes (1 x 1 x 1 cm) in a natural wood finish. Used to compare and calculate the volume of the cubes of the Pink Tower.

**Item Number: 0.024.20**



## Metal Volume Containers

With the Metal Volume Containers, the child discovers the rules for the calculation of volume. The 3 hollow geometric forms have the same base. The large rectangular prism and the pyramid have the same height, and the small rectangular prism is 1/3 of that height.

**Item Number: 0.128.00**

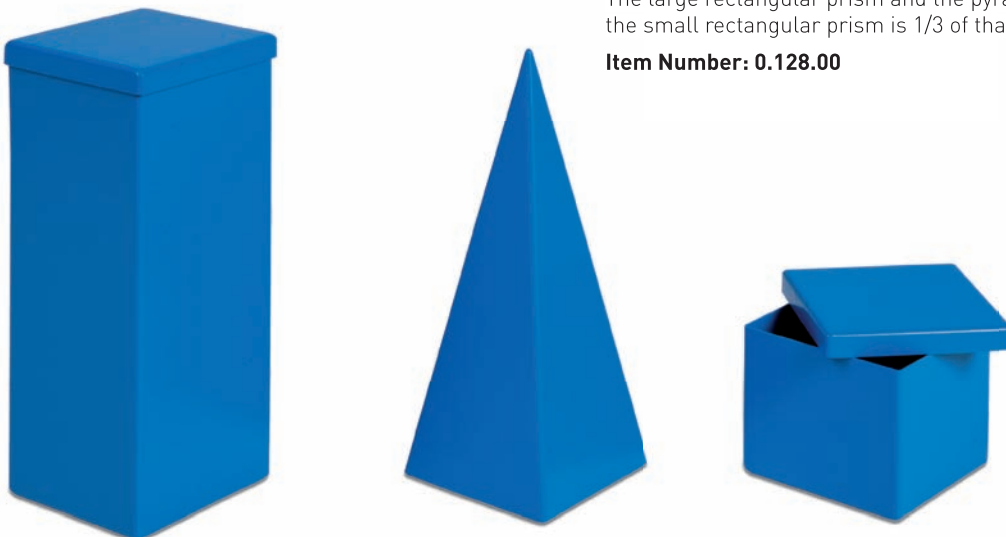



## Elementary Geometric Solids

A set of blue geometric solids used for the calculation of volume. The solids are derived from a base of 10 x 10 cm and a height of 20 cm. Each sold individually.



**Square Based Prism**  
Item Number: 0.188.01



**Rhombic Based Prism**  
Item Number: 0.188.02



**Triangular Based Prism**  
Item Number: 0.188.03



**2 Triangular Based Prisms**  
Item Number: 0.188.04



**Hexagonal Based Prism**  
Item Number: 0.188.05



**Divided Hexagonal Based Prism**  
Item Number: 0.188.06



**Short Square Based Prism**  
Item Number: 0.188.07



**Short Triangular Based Prism**  
Item Number: 0.188.08



**Square Based Pyramid**  
Item Number: 0.188.09



**Triangular Based Pyramid**  
Item Number: 0.188.10



**Cylinder**  
Item Number: 0.188.11



**Cone**  
Item Number: 0.188.12



**Short Cylinder**  
Item Number: 0.188.13



**Sphere**  
(Includes Clear Stand)  
Item Number: 0.188.14



**Ellipsoid**  
(Includes Clear Stand)  
Item Number: 0.188.15



**Ovoid**  
(Includes Clear Stand)  
Item Number: 0.188.16



# Biology

In the first three years of life, children have absorbed a limitless wealth of impressions, taking in all the elements of the world around them. Among these are a multitude of animals, plants, trees, and flowers – an infinite variety of growing things...

It is tremendously important to provide a mass of information to stimulate the children's interest in nature. A few simple keys will suffice to animate their inherent love of the natural world around them. With this information, this inherent love is transformed into their innate 'need to know' and 'understand it all'.

Once again, the child is given the names and the opportunity for sensorial exploration, which is ultimately organized through the Montessori Biology Materials. These materials provide them with the names of the animals and their parts, the basic leaf shapes, parts of the leaves, parts of the plants, parts of the flower and so on to help classify and refine the child's perception, and in turn, this creates the foundation for scientific knowledge to be acquired in the years to come.

### Botany Cabinet

Using the Botany Cabinet, the child learns the shapes and names of leaves by tracing their borders and matching them to those in the natural environment. The Botany Cabinet consists of: a beech plywood cabinet with 3 drawers and 18 leaf-shape insets and frames. 49 x 34 x 16 cm.

**Item Number: 0.041.00**

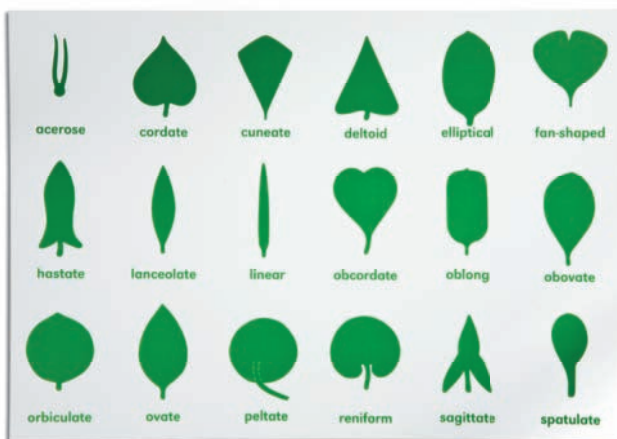

### Botany Cabinet Control Chart

A chart for use with the Botany Cabinet and the Botany Cabinet Nomenclature Cards. Printed in green on thick white plastic.

**Item Number: 0.041.C1**

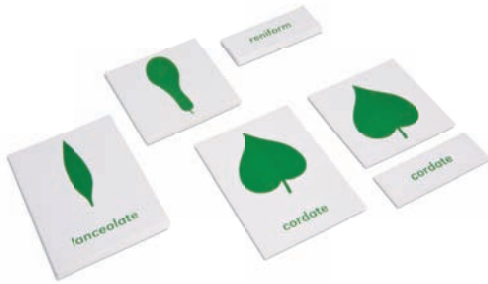

## Botany Cabinet: Nomenclature Cards

Two sets of 18 leaf shapes on cards. One set with separate labels and one control set labeled at the bottom.

**Item Number: 5.627.00**

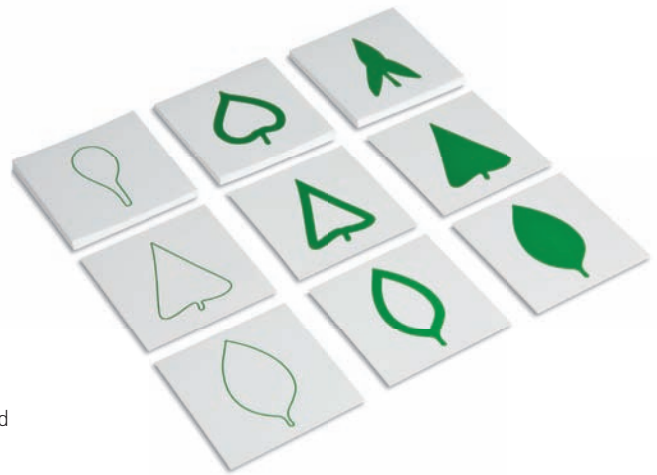

## Leaf Cards

The Leaf Cards aid the child in moving from the concrete representation of leaf shapes to abstraction. There are three series of 18 cards that correspond to the leaf shapes contained within the Botany Cabinet. In the first series, the forms are filled in (solid), the second series has a thick outline of each shape, and the third series has a thin outline of each shape.

**Item Number: 0.043.00**



## Leaf Cards Cabinet

A wooden cabinet with 3 shelves designed to organize the Leaf Cards to correspond with the drawers of the Botany Cabinet.

**Item Number: 0.044.00**



## Leaf Cards Box

A box with 3 compartments used for storing the Leaf Cards.

**Item Number: 0.040.A0**



**Geometry/Biology Cabinet (69 cm)**

A cabinet designed to store all the basic geometry or biology material. The dimensions are 53 x 69 x 46 cm, which is suitable for children up to 6 years of age.

**Item Number: 1.822.00**



**Geometry/Biology Cabinet (101 cm)**

A cabinet designed to store and/or display the basic geometry or biology material. The dimensions are 53 x 101 x 46 cm, which is suitable for children from 3 to 12 years of age.

**Item Number: 1.875.00**



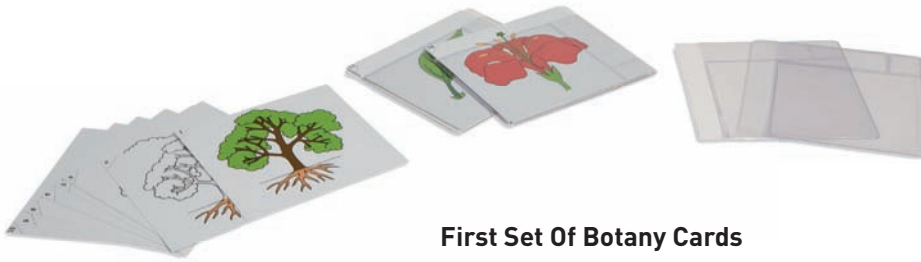

## First Set Of Botany Cards

The First Set Of Botany Cards contains cards illustrating the parts of: a plant, a root, a leaf and a flower.

**Item Number: 0.195.00**

## Name Cards: First Set Of Botany Cards

2 sets of plastic labels with the nomenclature of classification.

**Item Number: 0.195.A1**



## First Set Of Botany Cards Box

A wooden box with 4 compartments for storing the First Set Of Botany Cards.

**Item Number: 0.195.B0**





### Second Set Of Botany Cards

The Second Set Of Botany Cards is used for the identification and classification of roots, stems, leaves, flowers, fruits, seeds, parts of a bulb and parts of a mushroom.

**Item Number: 0.196.00**



### Name Cards: Second Set Of Botany Cards

2 sets of plastic labels with the nomenclature of classification.

**Item Number: 0.196.A1**



### Second Set Of Botany Cards Box

A wooden box with 22 compartments for storing the Second Set Of Botany Cards.

**Item Number: 0.196.B0**



## Third Set Of Botany Cards

The Third Set Of Botany Cards is used for the identification and classification of stems, leaves, flowers, fruits, and seeds.

**Item Number: 0.197.00**



## Name Cards: Third Set Of Botany Cards

2 sets of plastic labels with the nomenclature of classification.

**Item Number: 0.197.A1**



## Third Set Of Botany Cards Box

A wooden box with 32 compartments for storing the Third Set Of Botany Cards.

**Item Number: 0.197.B0**



## Botany Puzzles

A series of wooden puzzles whose pieces illustrate the component parts of a plant (tree), a leaf, a flower and a root. Puzzle size: 24 x 24 cm.



**Botany Puzzle: Tree**  
Item Number: 0.198.A0

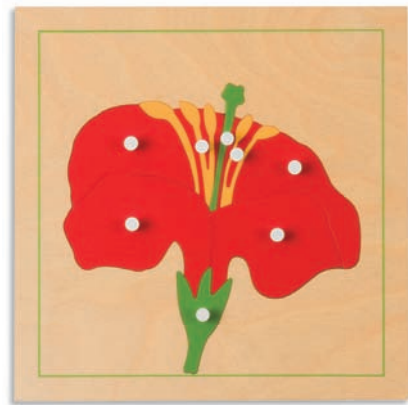

**Botany Puzzle: Flower**  
Item Number: 0.198.B0

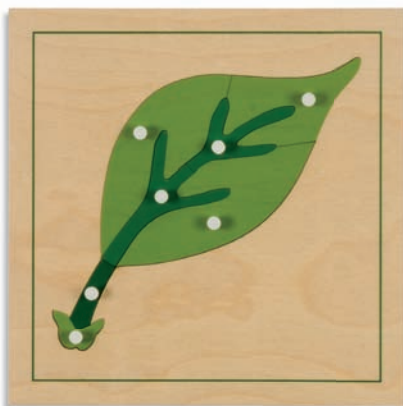

**Botany Puzzle: Leaf**  
Item Number: 0.198.C0

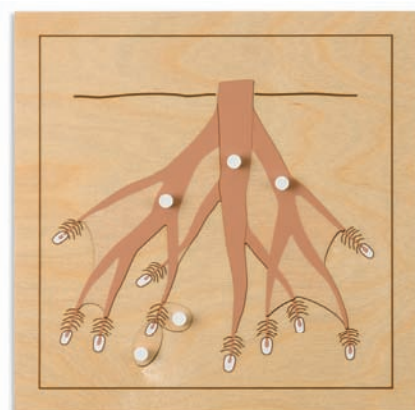

**Botany Puzzle: Root**  
Item Number: 0.198.D0



## Botany Puzzle Cabinet: Four Compartments

A beech plywood cabinet for storing the Botany Puzzles.

**Item Number: 0.200.50**

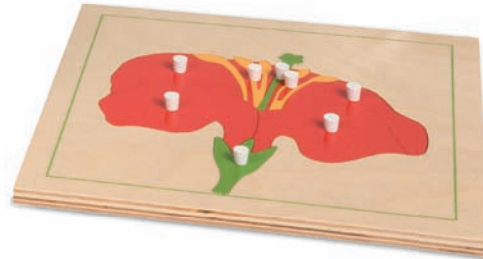

## Botany Puzzle: Copy Masters Box

Item Number: 0.204.00



## Botany Puzzle: Copy Masters

Four plastic cards with the Botany Puzzle illustrations for copying.

**Item Number: 0.205.00**

## Botany Puzzle Activity Set

Plastic control and name cards for each of the Botany Puzzle components. Includes: a wooden box with compartments and lid.

**Item Number: 0.202.01**



## Animal Puzzles

A series of wooden puzzles whose pieces illustrate the component parts of the different vertebrate groups.  
Puzzle size: 24 x 24 cm.



**Animal Puzzle: Horse**  
Item Number: 0.199.A0



**Animal Puzzle: Frog**  
Item Number: 0.199.B0



**Animal Puzzle: Fish**  
Item Number: 0.199.C0



**Animal Puzzle: Turtle**  
Item Number: 0.199.D0



**Animal Puzzle: Bird**  
Item Number: 0.199.E0



## Animal Puzzle Cabinet: Five Compartments

A beech plywood cabinet for storing the Animal Puzzles.

Item Number: 0.201.00



## Animal Puzzle: Copy Masters Box

Item Number: 0.206.00



## Animal Puzzle: Copy Masters

Five plastic cards with the Animal Puzzle illustrations for copying.

Item Number: 0.207.00

## Animal Puzzle Activity Set

Plastic control and name cards for each of the Animal Puzzle components. Includes: a wooden box with compartments and lid.

Item Number: 0.203.01





# Geography

With the Geography Materials, the child is given the facts of his physical world – that it is a sphere, that this sphere is composed of land masses and bodies of water, that these have different forms and that these forms have names.

The child at this age is also in a sensitive period for order, and the Geography Materials provide him with the opportunity for exploring the many levels of order established through the ages as we perceived and classified our earth – the countries, provinces, states - each with their own particular shapes, intriguing names, their capitals and their flags.

The child at this time is in the plane of intellectual development – the time of asking why, when, where, of all things. The facts learned and absorbed through this sensorial exploration provide a solid foundation for him to rediscover that which he already knows, and to further integrate it into his life. He can grasp and understand the characteristics of the land and the water, can begin to understand human affairs past and present that evolved, and is becoming aware of man's dependency on, and responsibility for, the habitat he shares with a myriad of other forms of life.



### **Globe Of Land And Water**

With the Globe Of Land And Water, the child gets a sensorial impression of land and water. The globe has a sand surface representing land and a smooth surface representing water. The wooden base holds the globe at a 23° angle, the same as the earth's axis in relation to the sun.

**Item Number: 0.230.00**



### **Globe Of The World Parts**

With the Globe Of The World Parts, the concept of continents is introduced. The globe has an entirely smooth surface, with a beige color representing land and blue representing water. The wooden base holds the globe at a 23° angle, the same as the earth's axis in relation to the sun.

**Item Number: 0.226.00**

### **Globe Of The Continents**

With the Globe Of The Continents, the concept of continents is reviewed with the child and the continents are named. These lead to work with the Puzzle Maps. The wooden base holds the globe at a 23° angle, the same as the earth's axis in relation to the sun.

**Item Number: 0.231.00**



### **Globe Projection Map: Set Of 10**

A paper map of the world designed to be cut out and glued together. When assembled, the globe fits perfectly on the Globe Of The Continents.

**Item Number: 0.231.50**

## Land And Water Forms

### Land And Water Form Trays

Molded dimensional trays representing actual land and water forms. These trays are to be filled with water that is colored blue. The trays are divided into two sets, which are ordered separately:



#### Land And Water Form Trays: Set 2

4 trays (20 x 20 x 4 cm) containing the following land and water forms:

- System of Lakes - Archipelago
- Bay - Cape

**Item Number: 0.228.00**

#### Box For Land Form Cards

**Item Number: 0.229.A0**



#### Land And Water Form Trays: Set 1

6 trays (20 x 20 x 4 cm) containing the following land and water forms:

- Lake - Island
- Gulf - Peninsula
- Strait - Isthmus

**Item Number: 0.227.00**

#### Land Form Cards

10 plastic cards illustrating the different land and water form shapes. These cards (20 x 20 cm) match the land and water form trays, and can be used for the abstraction and naming of the land and water forms.

**Item Number: 0.229.00**

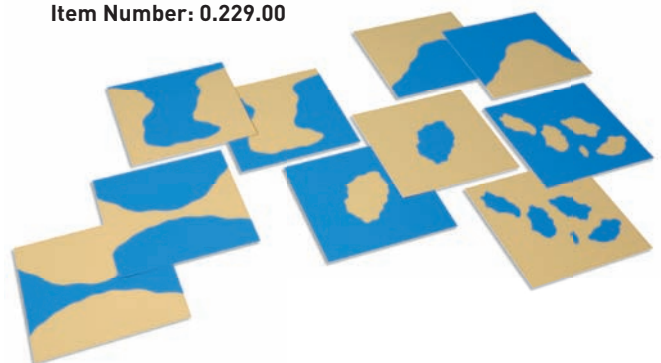

**Land And Water Form Cards: Set 1**

Based on Set 1 of the Land And Water Form Trays. Contains 2 sets of full color nomenclature cards. 1 set with separate labels and 1 control set labeled at the bottom and a spiral bound book that contains a complete set for teaching and reference use. Cards are made of plastic for durability. Includes a wooden box for storage.

**Item Number: 0.766.01**

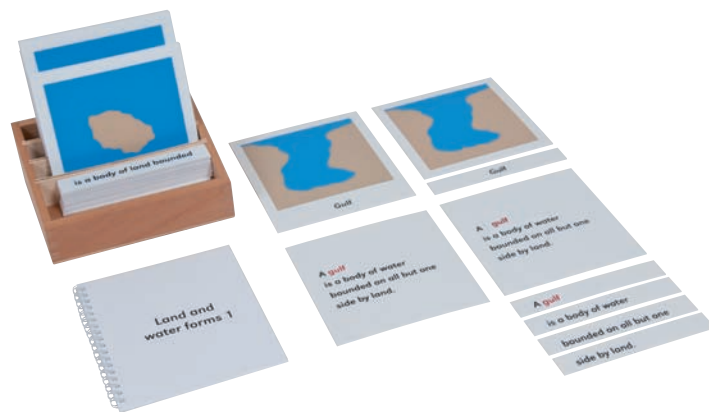

**Land And Water Form Cards: Set 2**

Based on Set 2 of the Land And Water Form Trays. Contains 2 sets of full color nomenclature cards. 1 set with separate labels and 1 control set labeled at the bottom and a spiral bound book that contains a complete set for teaching and reference use. Cards are made of plastic for durability. Includes a wooden box for storage.

**Item Number: 0.767.01**

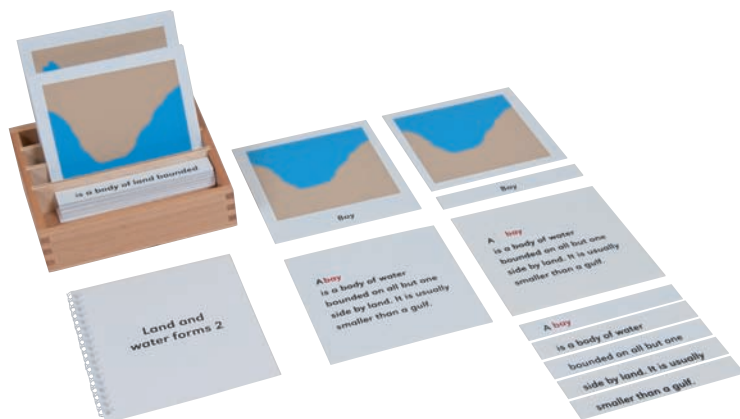

## Land And Water Forms

### Land And Water Forms: Card Set

Ten sets of Land And Water Forms Cards for matching, vocabulary, nomenclature and definition sets I, II and III. The Land And Water Forms are 6 basic forms: Island-Lake, Peninsula-Gulf, Isthmus-Strait, and 4 advanced forms: Archipelago-System of Lakes and Cape-Bay. Printed in color on white card stock.

**Item Number: 5.505.00**



### Land And Water Forms: Command Cards 1

Command cards for primary Land And Water Forms exercises. 48 cards printed on white card stock.

**Item Number: 5.502.00**

### Land And Water Forms: Command Cards 2

Command cards for the upper primary/elementary Land And Water Forms exercises. 63 cards printed on white card stock.

**Item Number: 5.504.00**



### Land And Water Forms: Labels

12 sheets of labels for the largest islands, lakes, gulfs, oceans, seas, rivers, mountain ranges, deserts, etc. of the world. 2 sets of sheets for cutting into labels and/or control chart use.

**Item Number: 5.503.00**

**World**



**Puzzle Maps**

Through sensorial activities with the Puzzle Maps, the children begin to build their knowledge of world geography. The silkscreened maps are laser cut. Laser cutting insures accuracy and the availability of replacement pieces. Specially designed knobs on each puzzle piece are positioned on the location of the capitals of the countries and states.

**Extra Circle For Tracing**

**Item Number: 0.177.A0**



**Puzzle Map: World Parts - Asia View**

Includes plastic circle for tracing the hemispheres.

**Item Number: 0.177.06**

**Puzzle Map: World Parts**

Includes plastic circle for tracing the hemispheres.

**Item Number: 0.177.00**



**World Control Map: Labeled**

**Item Number: 5.512.10**



**World Control Map: Unlabeled**

**Item Number: 5.512.00**

## World

### Hemisphere Maps And Labels Set

Includes:

- 1 Unlabeled Map
- 1 Map - Labeled by continents
- 1 Map - Labeled by oceans & seas
- 1 Map - Labeled by continents, oceans & seas
- 1 Set of labels

**Item Number: 5.511.00**



### Continent: Labels

**Item Number: 5.558.00**



### World: Political With Lakes (50)

**Item Number: 5.510.00**



### World: Outline (50)

**Item Number: 5.508.00**



### World: Political (50)

**Item Number: 5.509.00**

## Australia

**Puzzle Map: Australia**  
Item Number: 0.176.H0



**Australia Control Map: Labeled**  
Item Number: 5.546.00



**Australia Control Map: Unlabeled**  
Item Number: 5.553.00



**Australia: Labels**  
Item Number: 5.561.00



**Australia: Outline (50)**  
Item Number: 5.520.00



**Australia: Waterways (50)**  
Item Number: 5.521.00



**Australia: State Boundaries (50)**  
Item Number: 5.522.00



# Geography

## Europe



**Puzzle Map: Europe**  
Item Number: 0.176.B0



**Europe Control Map: Labeled**  
Item Number: 5.547.00



**Europe Control Map: Unlabeled**  
Item Number: 5.554.00



**Europe: Labels**  
Item Number: 5.562.00



**Europe: Outline (50)**  
Item Number: 5.523.00



**Europe: Waterways (50)**  
Item Number: 5.524.00



**Europe: Political (50)**  
Item Number: 5.525.00







**Puzzle Map: Asia**  
Item Number: 0.176.60



**Asia Control Map: Labeled**  
Item Number: 5.545.00



**Asia: Waterways (50)**  
Item Number: 5.518.00



**Asia: Labels**  
Item Number: 5.560.00



**Asia Control Map: Unlabeled**  
Item Number: 5.552.00



**Asia: Outline (50)**  
Item Number: 5.517.00



**Asia: Political (50)**  
Item Number: 5.519.00

**Asia**

## North America



**Puzzle Map: North America**  
Item Number: 0.176.C0



**North America Control Map: Labeled**  
Item Number: 5.548.00



**North America Control Map: Unlabeled**  
Item Number: 5.555.00



**North America: Labels**  
Item Number: 5.563.00



**North America: Outline (50)**  
Item Number: 0.526.00



**North America: Waterways (50)**  
Item Number: 5.527.00



**North America: Political (50)**  
Item Number: 5.528.00

**South America**



**Puzzle Map: South America**  
Item Number: 0.176.E0



**South America Control Map: Labeled**  
Item Number: 5.549.00



**South America Control Map: Unlabeled**  
Item Number: 5.556.00



**South America: Labels**  
Item Number: 5.564.00



**South America: Outline (50)**  
Item Number: 5.529.00



**South America: Waterways (50)**  
Item Number: 5.530.00



**South America: Political (50)**  
Item Number: 5.531.00

## Africa



**Puzzle Map: Africa**

Item Number: 0.176.F0



**Africa Control Map: Labeled**

Item Number: 5.544.00

**Africa: Labels**

Item Number: 5.559.00



**Africa Control Map: Unlabeled**

Item Number: 5.551.00



**Africa: Outline (50)**

Item Number: 5.514.00



**Africa: Waterways (50)**

Item Number: 5.515.00



**Africa: Political (50)**

Item Number: 5.516.00

## United States



**Puzzle Map: The United States**  
Item Number: 0.236.00



**United States: Labels**  
Item Number: 5.565.00



**United States Control Map: Unlabeled**  
Item Number: 5.557.00



**United States Control Map: Labeled**  
Item Number: 5.550.00



### United States Location Color Set

Maps for coloring the states as directed by the command cards. Each card directs the child to locate a particular state and color it a specified color, then check off that state in the list. Includes 1 fully colored map with the names of the states for control. 50 sheets.

**Item Number: 5.535.00**



### United States: Outline (50)

**Item Number: 5.532.00**



### United States: Waterways (50)

**Item Number: 5.533.00**



### United States: State Boundaries (50)

**Item Number: 5.534.00**

## Canada



**Puzzle Map: Canada**  
Item Number: 0.237.00



**Canada Control Map: Labeled**  
Item Number: 5.550.10



**Canada Control Map: Unlabeled**  
Item Number: 5.557.10



**Canada: Labels**  
Item Number: 5.565.10

## Mexico



**Puzzle Map: Mexico**  
Item Number: 0.236.B0



**Mexico Control Map: Labeled**  
Item Number: 5.574.00



**Mexico Control Map: Unlabeled**  
Item Number: 5.573.00

**Mexico: Labels**  
Item Number: 5.575.00







**Puzzle Map: Switzerland**  
Item Number: 0.175.D0

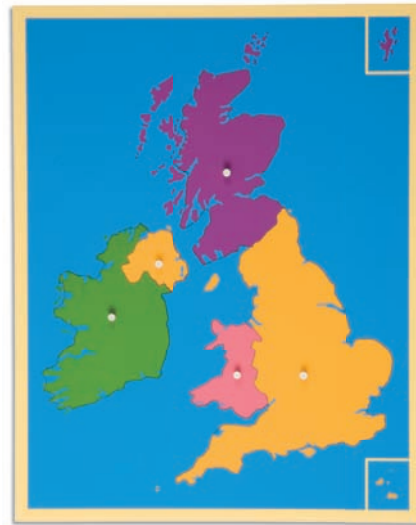

**Puzzle Map: The United Kingdom**  
Item Number: 0.175.E0



**Puzzle Map: Ireland**  
Item Number: 0.175.F0



**Puzzle Map: Sweden**  
Item Number: 0.175.K0



**Puzzle Map: The Netherlands**  
Item Number: 0.175.00



**Puzzle Map: Germany**  
Item Number: 0.175.A0



**Puzzle Map: France**  
Item Number: 0.175.C0

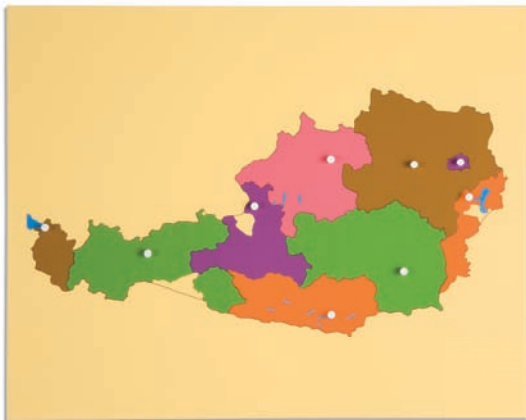

**Puzzle Map: Austria**  
Item Number: 0.175.B0



**Puzzle Map: Japan**  
Item Number: 0.241.00



**Puzzle Map: Taiwan**  
Item Number 0.242.00



**Puzzle Map: China**  
Item Number: 0.243.00



### Puzzle Map Cabinet

A beech plywood cabinet that stores 12 Puzzle Maps. 61 x 62 x 47 cm.

**Item Number: 1.740.00**

### Puzzle Map Stand

This beechwood stand holds up to eight puzzle maps and is designed for efficient storage. 65 x 70 x 55 cm.

**Item Number: 0.176.A0**



### Cabinet For Paper Maps

A wooden cabinet with 6 shelves used for storing Paper Maps (maps not included).

**Item Number: 1.626.00**

### Cards Of The World Parts

This material helps the child move to a more abstract understanding of the continents. The 14 heavy plastic silk-screened cards form two sets. One set with the continents and names, and the other set with only the continents. A set of loose name labels in a plastic box is included.

**Item Number: 0.235.01**

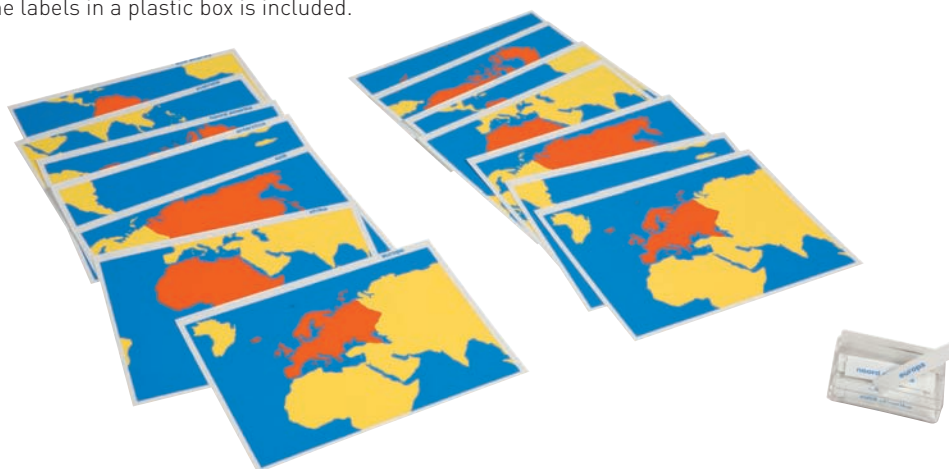

### Four Maps Of Europe

The child explores country names, capital names and national flags with this set of 4 maps. Consists of 3 control maps and 1 working map - a control map for country names, a control map for capital names and a control map for national flags. The working map has holes for pin flags. Included are a set of green pin flags for the country names, a set of red pin flags for the capital names, and a set of national flag pins. Self-adhesive name labels for the country and capital pin flags are also included.

**Item Number: 0.179.01**



### Pin Flag Stand

A stand for holding the pin flags. To be used with the Geography Cabinets, The Pin Maps or The Stars Exercise. Made of a self-healing material (flags not included).

**Item Number: 0.174.00**



## Four Maps Of North America

The child explores country names, capital names and national flags with this set of 4 maps. Consists of 3 control maps and 1 working map - a control map for country names, a control map for capital names and a control map for national flags. The working map has holes for pin flags. Included are a set of green pin flags for the country names, a set of red pin flags for the capital names and a set of national flag pins. Self-adhesive name labels for the country and capital pin flags are also included.

**Item Number: 0.238.00**



## Four Maps Of South America

The child explores country names, capital names and national flags with this set of 4 maps. Consists of 3 control maps and 1 working map - a control map for country names, a control map for capital names and a control map for national flags. The working map has holes for pin flags. Included are a set of green pin flags for the country names, a set of red pin flags for the capital names and a set of national flag pins. Self-adhesive name labels for the country and capital pin flags are also included.

**Item Number: 0.239.00**

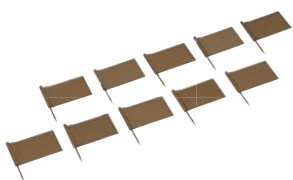

## Extra Flags: Gold (10)

10 blank gold flags for use with The Pin Maps and the Cabinet Of The USA.

**Item Number: 0.174.A5**

### Cabinet Of The USA

The Cabinet of the United States contains 13 maps for use by the child to label the major geographical and political parts of the USA and its territories. The child identifies the major features of each state by placing labeled pin flags of differing colors in the correct holes on the maps. Green for the states, red for the cities, blue for water, yellow for mountains, and white for islands. In addition, a label and pin for each state flag is included. The material consists of a beech plywood cabinet with 13 map drawers, pin flags in boxes, control maps and self-adhesive name labels to apply to the flags. The cabinet is 49 x 34 x 39 cm.

**Item Number: 0.240.01**

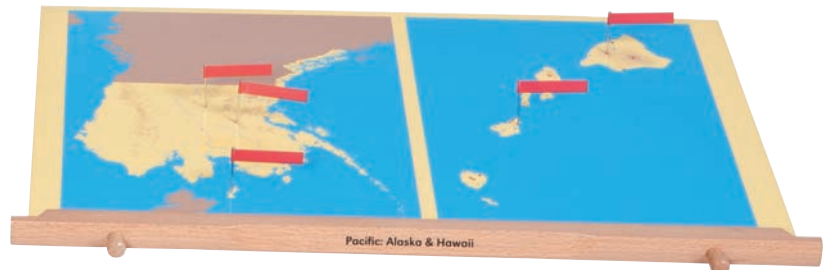
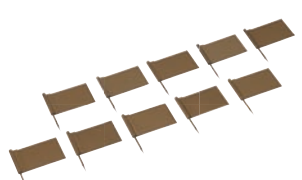

### Extra Flags: Gold (10)

10 blank gold flags for use with The Pin Maps and the Cabinet Of The USA.

**Item Number: 0.174.A5**



## Cabinet Of The World Parts

The Cabinet Of the World Parts contains 6 maps for use by the child to label the major geographic and political world parts. The child places labeled pin flags of different colors in holes on the maps identifying the major features of each continent, green for countries, red for cities, blue for water, yellow for mountains, and white for islands. The material consists of a beech plywood cabinet with 6 continent maps, boxes of pin flags, control maps and self-adhesive name labels to apply to the flags. 49 x 34 x 25 cm.

**Item Number: 0.173.01**

### Extra Flags:

Item Number: 0.174.A0 - Yellow (10)

Item Number: 0.174.A1 - Red (10)

Item Number: 0.174.A2 - Green (10)

Item Number: 0.174.A3 - Blue (10)

Item Number: 0.174.A4 - White (10)





### Cabinet Of Europe

The Cabinet Of Europe contains 12 maps for use by the child to label the major geographic and political parts of Europe. The child places labeled pin flags of different colors in holes on the maps identifying the major features of each country, green for countries, red for cities, blue for water, yellow for mountains, and white for islands. The material consists of a beech plywood cabinet with 12 maps, boxes of pin flags, control maps and self-adhesive name labels to apply to the flags. 49 x 34 x 39 cm.

**Item Number: 0.170.01**



#### Extra Flags:

Item Number: 0.174.A0 - Yellow (10)

Item Number: 0.174.A1 - Red (10)

Item Number: 0.174.A2 - Green (10)

Item Number: 0.174.A3 - Blue (10)

Item Number: 0.174.A4 - White (10)



## Large Chart Of The World

A large chart made of a coated fabric measuring 130 x 280 cm. The chart is designed for children to have an interactive experience with the world while they learn. They can sit on the chart while laying out word cards, animals or pictures belonging to the different world parts.

**Item Number: 0.780.00**

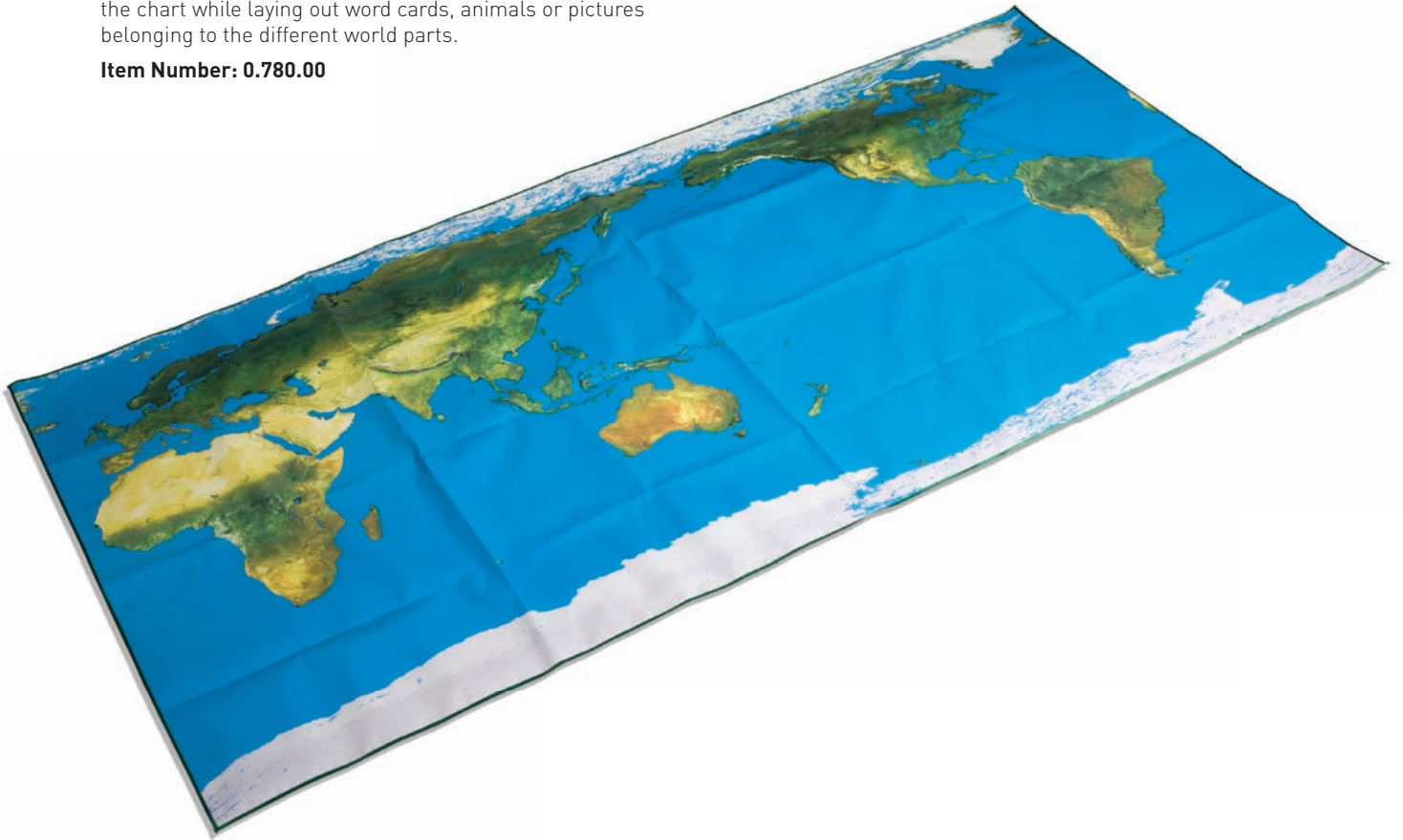

### Flag Stand Of Asia

A wooden flag stand with the national flags of each of the countries.

**Item Number: 0.232.00**



### Flag Stand Of Europe

A wooden flag stand with the national flags of each of the countries.

**Item Number: 0.233.00**

### Flag Stand Of Africa

A wooden flag stand with the national flags of each of the countries.

**Item Number: 0.233.B0**



### Flag Stand Of North And South America

A wooden flag stand with the national flags of each of the countries.

**Item Number: 0.233.A0**

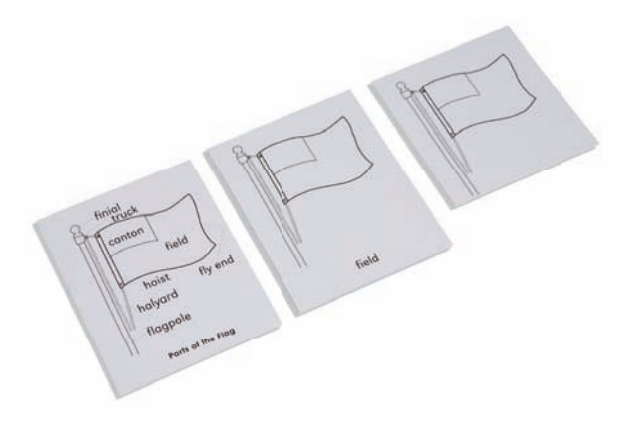

## Parts Of The Flag Nomenclature Cards

2 sets of flag nomenclature cards for naming parts of the flag. 1 set with separate labels, 1 control set labeled at the bottom and 1 separate card with all the parts labeled is included. Printed in black on white card stock.

**Item Number: 5.538.00**

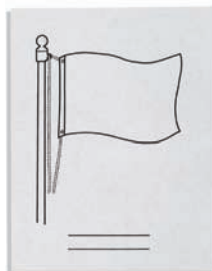

## Flag Paper

500 sheets. The child identifies one of the flag parts and labels it below. Used with 5.538.00.

**Item Number: 5.539.00**



## Parts Of The Flag Descriptions

2 sets of description cards for describing parts of the flag. 1 set with separated descriptions and 1 control set. Printed in black on white card stock. Used with 5.538.00.

**Item Number: 5.540.00**



### Flags Of Africa

Contains 2 sets of full color nomenclature cards. 1 set with separate labels and 1 control set labeled at the bottom and a spiral bound book that contains a complete set for teaching and reference use. Cards are made of plastic for durability. Includes a wooden box for storage.

**Item Number: 0.760.01**

### Flags Of Asia

Contains 2 sets of full color nomenclature cards. 1 set with separate labels and 1 control set labeled at the bottom and a spiral bound book that contains a complete set for teaching and reference use. Cards are made of plastic for durability. Includes a wooden box for storage.

**Item Number: 0.761.01**



### Flags Of Europe

Contains 2 sets of full color nomenclature cards. 1 set with separate labels and 1 control set labeled at the bottom and a spiral bound book that contains a complete set for teaching and reference use. Cards are made of plastic for durability. Includes a wooden box for storage.

**Item Number: 0.762.01**





## Flags Of North America

Contains 2 sets of full color nomenclature cards. 1 set with separate labels and 1 control set labeled at the bottom and a spiral bound book that contains a complete set for teaching and reference use. Cards are made of plastic for durability. Includes a wooden box for storage.

**Item Number: 0.763.01**

## Flags Of The United States

Contains 2 sets of full color nomenclature cards. 1 set with separate labels and 1 control set labeled at the bottom and a spiral bound book that contains a complete set for teaching and reference use. Cards are made of plastic for durability. Includes a wooden box for storage.

**Item Number: 0.764.01**



## Flags Of South America

Contains 2 sets of full color nomenclature cards. 1 set with separate labels and 1 control set labeled at the bottom and a spiral bound book that contains a complete set for teaching and reference use. Cards are made of plastic for durability. Includes a wooden box for storage.

**Item Number: 0.765.01**



# Accessories

Nienhuis has a variety of products that are used in conjunction with the core Montessori materials. As you have come to expect, these materials are of the highest quality.

We have grouped them together in one chapter to help you explore and view them as effectively as possible.

First you will find our Activity Sets. These items are to be used with specific Montessori materials such as: The Geometric Cabinet, Bead Frames, Fractions, Golden Bead Material, and many more. To keep in line with our high standard, they have all been developed by an AMI Montessori Teacher-Trainer. The cards are printed on high-quality plastic for durability and come housed in a wooden box.

In addition, you will find a wide variety of basic classroom necessities such as colored inset pencils, sharpeners, scissors, punch-out pins and material storage blocks. A selection of papers for mathematics and language exercises as well as photos of Dr. Montessori. To maintain and keep your materials in top condition, our Repair Paints and First Aid Kits are also included.



**Activity Sets**



**Golden Bead Material Activity Set**

Additional exercises for use with The Golden Bead Material. Includes: exercise cards, divider tabs and a wooden box for storage.

**Item Number: 0.600.01**



**Stamp Game Activity Set**

Additional exercises for use with The Stamp Game. Includes: exercise cards, divider tabs and a wooden box for storage.

**Item Number: 0.601.01**



**Bank Game Activity Set**

Additional exercises for use with The Bank Game. Includes: exercise cards, divider tabs and a wooden box for storage.

**Item Number: 0.603.01**



**Checker Board Activity Set**

Additional exercises for use with The Checker Board. Includes: exercise cards, divider tabs and a wooden box for storage.

**Item Number: 0.602.01**



**Small Bead Frame Activity Set**

Additional exercises for use with The Small Bead Frame. Includes: exercise cards, divider tabs and a wooden box for storage.

**Item Number: 0.604.01**

## Activity Sets



### Large Bead Frame Activity Set

Additional exercises for use with The Large Bead Frame. Includes: exercise cards, divider tabs and a wooden box for storage.

**Item Number: 0.605.01**

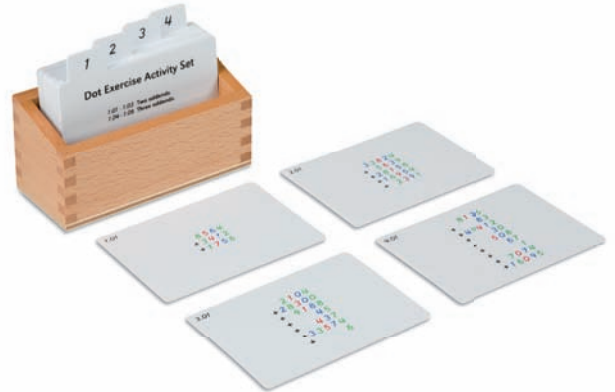

### Dot Exercise Activity Set

Additional exercises for use with The Dot Exercise. Includes: exercise cards, divider tabs and a wooden box for storage.

**Item Number: 0.606.01**



### Long Division Activity Set

Additional exercises for use with the Long Division material. Includes: exercise cards, divider tabs and a wooden box for storage.

**Item Number: 0.607.01**



### Flat Bead Frame Activity Set

Additional exercises for use with The Flat Bead Frame. Includes: exercise cards, divider tabs and a wooden box for storage.

**Item Number: 0.608.01**



**Geometric Solids Activity Set**

Additional exercises for use with The Geometric Solids. Includes: exercise cards, divider tabs and a wooden box for storage.

**Item Number: 0.609.01**



**Geometric Cabinet Activity Set**

Additional exercises for use with The Geometric Cabinet. Includes: exercise cards, divider tabs and a wooden box for storage.

**Item Number: 0.610.01**



**Constructive Blue Triangles Activity Set**

Additional exercises for use with The Constructive Blue Triangles. Includes: exercise cards, divider tabs and a wooden box for storage.

**Item Number: 0.611.01**



**Hundred Board Activity Set**

Additional exercises for use with The Hundred Board. Includes: exercise cards, divider tabs and a wooden box for storage.

**Item Number: 0.612.01**

**Hundred Board Copy Masters**

A set of plastic sheets for copying.

**Item Number: 0.612.51**

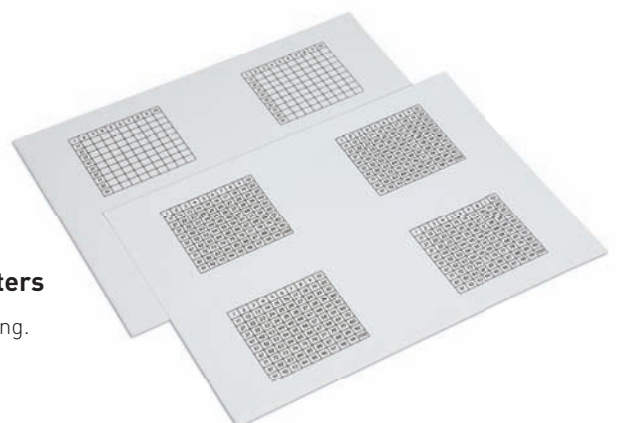

## Activity Sets



### Algebraic Peg Board Activity Set: 1

Additional exercises for use with The Algebraic Peg Board. Includes: exercise cards, divider tabs and a wooden box for storage.

**Item Number: 0.613.01**

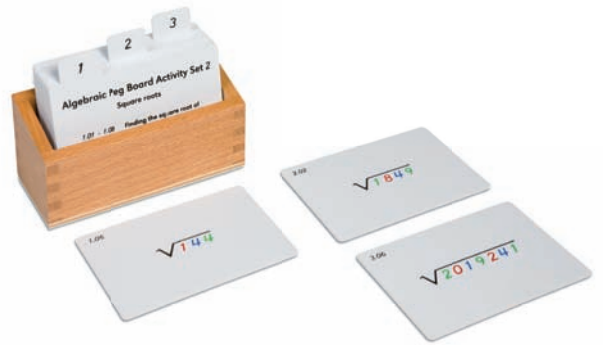

### Algebraic Peg Board Activity Set: 2

Additional exercises for use with The Algebraic Peg Board. Includes: exercise cards, divider tabs and a wooden box for storage.

**Item Number: 0.614.01**



### Fractions Activity Set: 1

Additional exercises for use with The Cut-Out Fractions. Includes: exercise cards, divider tabs and a wooden box for storage.

**Item Number: 0.615.01**



### Fractions Activity Set: 2

Additional exercises for use with The Cut-Out Fractions. Includes: exercise cards, divider tabs and a wooden box for storage.

**Item Number: 0.616.01**



### Fractions Activity Set: 3

Additional exercises for use with The Cut-Out Fractions. Includes: exercise cards, divider tabs and a wooden box for storage.

**Item Number: 0.617.01**



**Inscribed And Concentric Figures Activity Set**

Additional exercises for use with The Inscribed And Concentric Figures. Includes: exercise cards, divider tabs and a wooden box for storage.

**Item Number: 0.619.01**



**Cut-Out Numerals And Counters Activity Set**

Additional exercises for use with The Cut-Out Numerals And Counters. Includes: exercise cards, divider tabs and a wooden box for storage.

**Item Number: 0.620.01**



**Multiplication Board Activity Set**

Additional exercises for use with The Multiplication Board. Includes: exercise cards, divider tabs and a wooden box for storage.

**Item Number: 0.621.01**

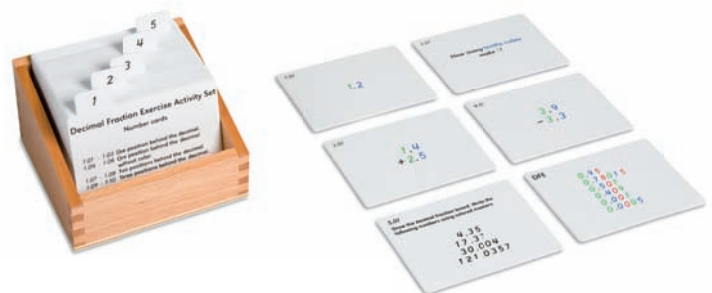

**Decimal Fraction Exercise Activity Set**

Additional exercises for use with The Decimal Fraction Exercise. Includes: exercise cards, divider tabs and a wooden box for storage.

**Item Number: 0.618.01**

## Activity Sets



### Pythagoras Board Activity Set

Additional exercises for use with The Pythagoras Board. Includes: exercise cards, divider tabs and a wooden box for storage.

**Item Number: 0.622.01**

### Pythagoras Board Copy Masters

A set of plastic sheets for copying.

**Item Number: 0.622.51**

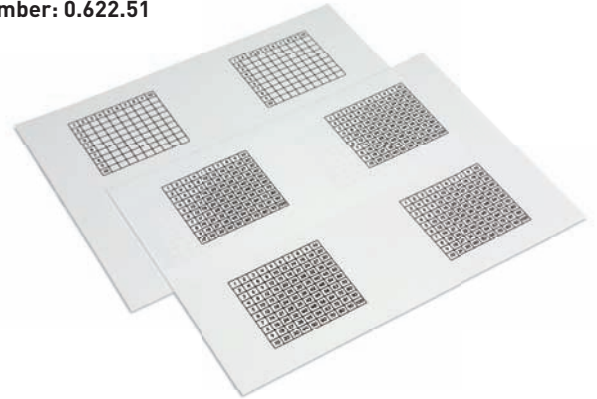

### Tellurium Activity Set

Additional exercises for use with Tellurium. Includes: exercises cards, divider tabs and a wooden box for storage.

**Item Number: 0.852.01**



### Unit Division Board Activity Set

Additional exercises for use with The Unit Division Board. Includes: exercise cards, divider tabs and a wooden box for storage.

**Item Number: 0.623.01**

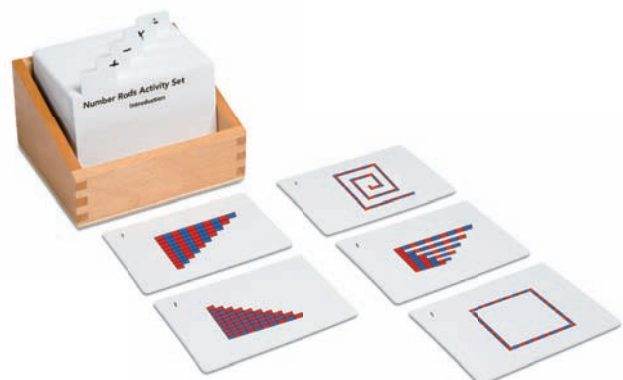

### Number Rods Activity Set

Additional exercises for use with the Number Rods. Includes: exercise cards, divider tabs and a wooden box for storage.

**Item Number: 0.628.01**



**6 Hole Storage Block: For Pencil/Glue Brushes**

A solid beechwood block used for holding 6 pencils or glue brushes.

**Item Number: 7.302.00**

**12 Hole Storage Block: For Pencil/Glue Brushes**

A solid beechwood block used for holding 12 pencils or glue brushes.

**Item Number: 7.301.00**



**Natural Wood Inset Pencil Holder**

**Item Number: 7.317.00**



**Colored Inset Pencil Holders: Set Of 11**

**Item Number: 7.305.00**

## Storage • Classroom Necessities

### Storage Block: For Art & Pasting Materials

A solid beechwood block used for holding 1 paste/glue jar, 1 punch-out pin, 1 glue brush, and 1 pair of scissors.

**Item Number: 7.611.00**



### Glue/Paint/Paste Jar With Lid: (50 cc)

A 50 cc glass jar with a screw top lid for storing glue, paint or paste.

**Item Number: 040.110**



### Paste Or Glue Brush (20 cm): Per 12

**Item Number: 040.094**



### Glue And Paste Box

An all-inclusive set for gluing and pasting exercises in the classroom. Includes: a wooden box with six compartments, a glue/paste brush and a glass jar with lid. The lid of the box has a cutout hole that holds the jar upright to avoid spilling the contents.

**Item Number: 0.401.00**





**Punch-Out Pad**  
Item Number: 083.002

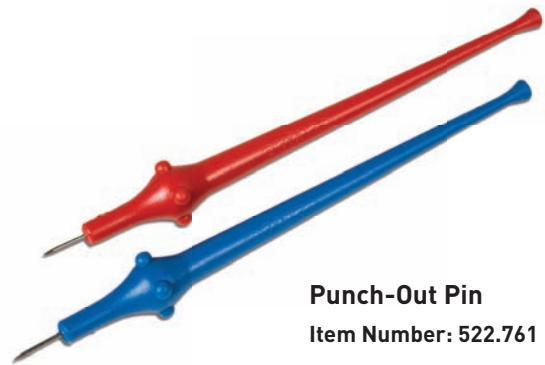

**Punch-Out Pin**  
Item Number: 522.761



**12 Hole Storage Block: For Punch-Out Pins**

A solid beechwood block used for holding 12 punch-out pins.

**Item Number: 7.656.00**

**Plastic Sleeve For Nomenclature Cards: (10)**

Use for children's work activities, storing materials or giving presentations.  
Set includes 10 sleeves; each with 4 sections across.

**Item Number: 550.100**



## Storage • Classroom Necessities



**Blunt Scissors: 10 cm**  
Item Number: 7.701.00



**Toddler Scissors: 9 cm**  
Item Number: 7.703.00



**Sharp Scissors: 13 cm**  
Item Number: 076.002

### 12 Hole Storage Block: For Scissors

A solid beechwood block used for holding 12 pairs of scissors.

**Item Number: 7.710.00**



### Cutting And Scissor Tray

An all-inclusive set for cutting exercises in the classroom. Includes: a wooden tray and small box, a pair of scissors and several scissors exercise sheets. See 5.677.00 Scissors Exercises to order additional sheets.

**Item Number: 0.400.00**



### Scissors Exercises

14 sequential exercises used for the development of scissors mastery. Narrow strips are for single-cut exercises and wide strips for multiple cuts. 14 different strips provide progressive levels of difficulty. Includes: micro-perforated pads for easy removal of individual cutting strips and convenient storage, 3400 strips: 8-10/sheet, 50 sheets/pad and instructions.

**Item Number: 5.677.00**

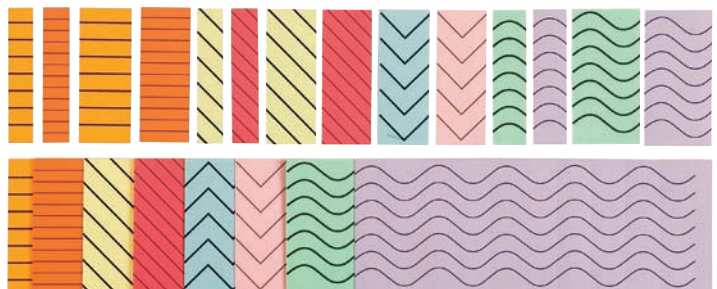

**Small Blackboard Eraser**

Item Number: 7.405.00



**Rubber Desk Top Pad: 14 x 14 cm**

Item Number: 9.157.00

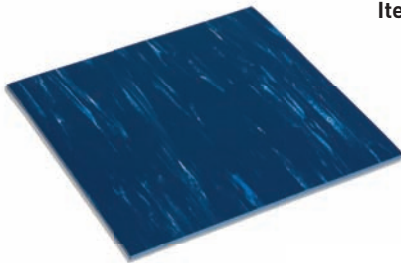

**Inset Paper Box: 14 x 14 cm**

Item Number: 7.023.00



**Holder For 3 Pencils**

Item Number: 7.304.00



## Inset Pencils

### 3-Sided Inset Pencils

Our 3-sided inset pencils come in a wide variety of colors that match perfectly with the Montessori materials. We chose 3-sided as it is more comfortable in the hand, and aids in teaching children the correct way to hold a pencil. 18 colors, sold in single boxes of 12.



**3-Sided Inset Pencils: Red**  
Item Number: 7.202.00



**3-Sided Inset Pencils: Gold**  
Item Number: 7.206.00



**3-Sided Inset Pencils: Dark Blue**  
Item Number: 7.203.00



**3-Sided Inset Pencils: Yellow**  
Item Number: 7.207.00



**3-Sided Inset Pencils: Green**  
Item Number: 7.204.00



**3-Sided Inset Pencils: Orange**  
Item Number: 7.208.00



**3-Sided Inset Pencils: Violet**  
Item Number: 7.205.00



**3-Sided Inset Pencils: Light Blue**  
Item Number: 7.209.00

**Inset Pencils**



**3-Sided Inset Pencils: Light Green**  
Item Number: 7.210.00



**3-Sided Inset Pencils: White**  
Item Number: 7.214.00



**3-Sided Inset Pencils: Black**  
Item Number: 7.211.00



**3-Sided Inset Pencils: Dark Green**  
Item Number: 7.215.00



**3-Sided Inset Pencils: Gray**  
Item Number: 7.211.50



**3-Sided Inset Pencils: Light Yellow**  
Item Number: 7.216.00



**3-Sided Inset Pencils: Pink**  
Item Number: 7.212.00



**3-Sided Inset Pencils: Light Brown**  
Item Number: 7.217.00



**3-Sided Inset Pencils: Brown**  
Item Number: 7.213.00



**3-Sided Inset Pencils: Peach**  
Item Number: 7.218.00

## Inset Pencils



**11 Dozen Inset Pencils: 11 Colors**  
Item Number: 7.201.00



### Heutink Goldline: Lead Pencils (12)

Lead pencils with medium lead hardness. Sold in boxes of 12.

Item Number: 061.065



### 3-Sided Lead Pencils: (72)

Lead pencils that match our 3-Sided Inset pencils. The 3-Sided pencil is more comfortable in the hand and aids in teaching the children the correct way to hold a pencil. Sold in a box of 72.

Item Number: 061.240



### Pencil Sharpener: For 3-Sided Pencils - Small

Item Number: 025.214



### Pencil Sharpener: For All Pencil Types - Table Model

Item Number: 035.055



### Pencil Sharpener: For All Pencil Types – Electric

Item Number: 035.063

**Paper And Booklets**  
Language



**Writing Paper: Blue Lines - 2 x 8.5 in - (500)**  
Item Number: 5.660.00

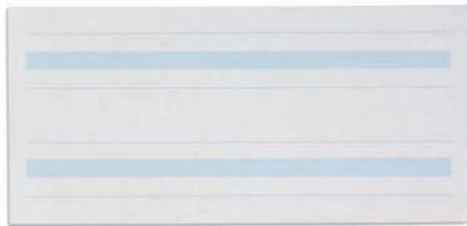

**Writing Paper: Blue Lines - 4 x 8.5 in - (500)**  
Item Number: 5.661.00

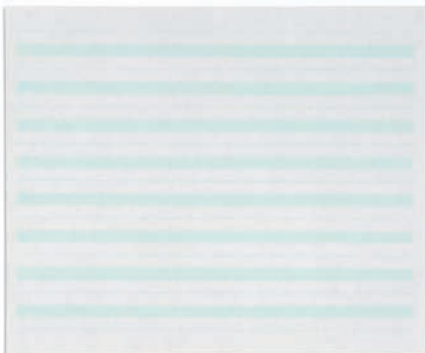

**Writing Paper: Green Lines - 7 x 8.5 in - (500)**  
Item Number: 5.668.00



**Writing Paper: Green Lines - 8.5 x 11 in - (500)**  
Item Number: 5.669.00

**Writing Paper: Blue Lines - 2.75 x 7 in - (500)**  
Item Number: 5.663.00

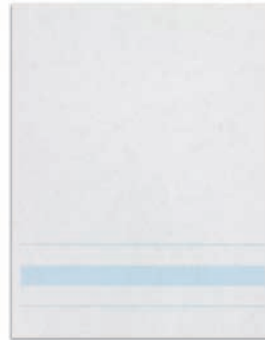

**Writing Paper: Blue Lines - 4.25 x 5.5 in - (500)**  
Item Number: 5.662.00

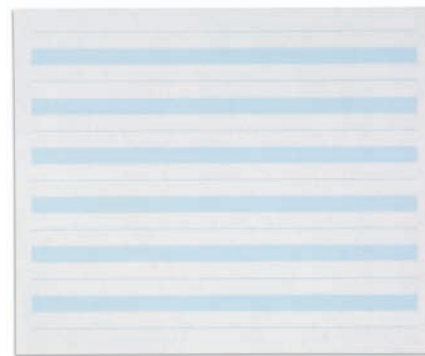

**Writing Paper: Blue Lines - 7 x 8.5 in - (500)**  
Item Number: 5.664.00



**Writing Paper: Blue Lines - 8.5 x 11 in - (500)**  
Item Number: 5.665.00



## Paper And Booklets

Language



**Inset Paper: (3000)**  
Item Number: 5.679.00



**Single Lined Paper: (250)**  
Item Number: 0.164.00



**Double Lined Paper: (250)**  
Item Number: 0.165.00



**Double Lined Paper: Wide Lines (250)**  
Item Number: 0.165.B0



**Writing Booklets: Yellow - Small (100)**  
Item Number: 0.166.B0

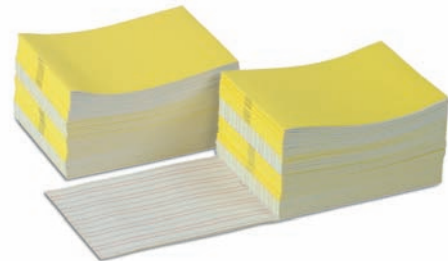

**Writing Booklets: Yellow - Large (100)**  
Item Number: 0.166.A0

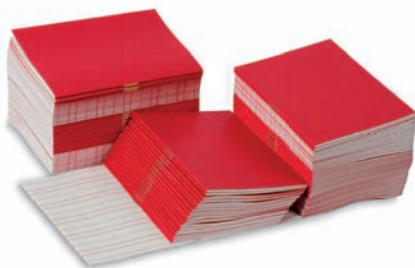

**Writing Booklets: Red - Small (100)**  
Item Number: 0.166.B1



**Writing Booklets: Red - Large (100)**  
Item Number: 0.166.A1



**Paper And Booklets**  
Mathematics

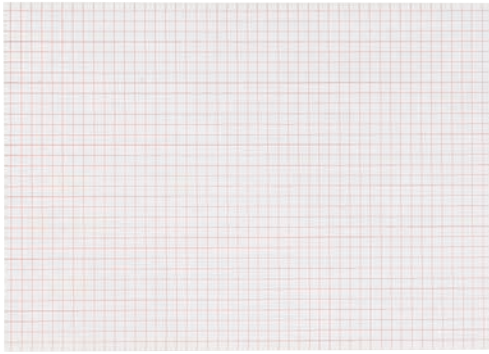

**Squared Paper: 6 mm (250)**  
Item Number: 0.162.00

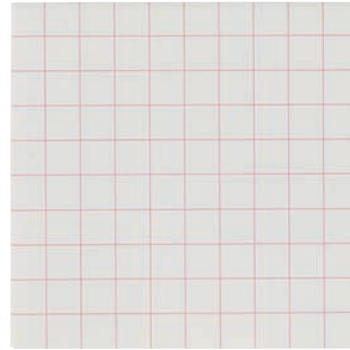

**Squared Paper: 14 mm (500)**  
Item Number: 0.145.00



**Squared Paper: 10 mm (250)**  
Item Number: 0.163.00

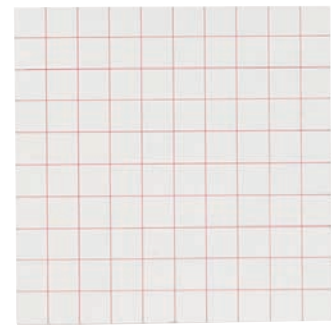

**Squared Paper: 10 X 10 cm (500)**  
Item Number: 0.145.B0

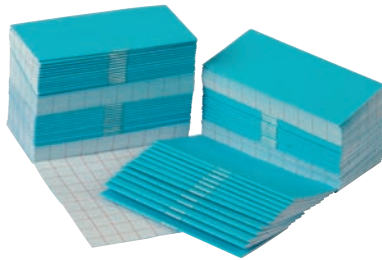

**Arithmetic Books: Blue - Small (100)**  
Item Number: 0.166.03

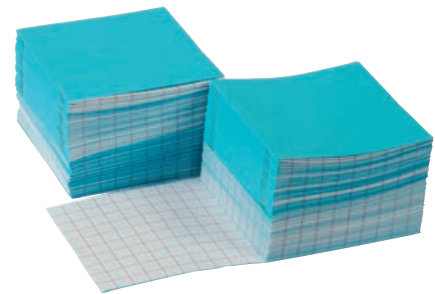

**Arithmetic Books: Blue - Large (100)**  
Item Number: 0.166.C3

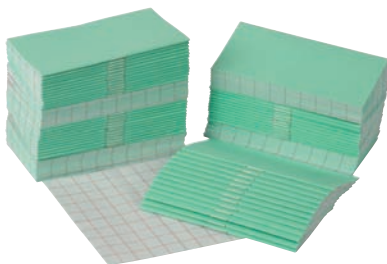

**Arithmetic Books: Green - Small (100)**  
Item Number: 0.166.02

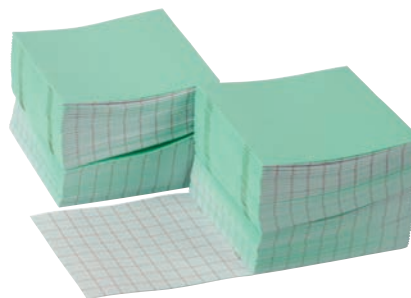

**Arithmetic Books: Green - Large (100)**  
Item Number: 0.166.C2

## Material Repair

### Material First Aid Kits

Indispensable kits used for maintaining your Nienhuis Montessori materials. The kits contain many of the most commonly requested spareparts. Includes a plastic box with lid.



#### Material First Aid Kit: Sensorial

Item Number: 0.320.00



#### Material First Aid Kit: Math

Item Number: 0.320.01



**Repair Paints**

We offer single bottles of our 'special mix' paint for use in re-touching your Montessori material. Includes a small paint brush in the lid. 9 colors: Pink, Red, Yellow, Green, Dark Blue, Brown, Black, Light Blue and Medium Blue. Clear Varnish and Thinner is also available.



**Bottle Of Repair Paint: Pink**  
Item Number: 9.500.10



**Bottle Of Repair Paint: Red**  
Item Number: 9.501.00



**Bottle Of Repair Paint : Yellow**  
Item Number: 9.502.00



**Bottle Of Repair Paint: Green**  
Item Number: 9.503.00



**Bottle Of Repair Paint: Dark Blue**  
Item Number: 9.504.00

## Material Repair



**Bottle Of Repair Paint: Brown (Old)**  
Item Number: 9.507.00



**Bottle Of Repair Paint: Black**  
Item Number: 9.508.00



**Bottle Of Repair Paint: Light Blue**  
Item Number: 9.509.00



**Bottle Of Repair Paint: Medium Blue**  
Item Number: 9.511.00



**Bottle Of Repair Paint: Clear Varnish**  
Item Number: 9.505.00



**Bottle Of Repair Paint: Thinner**  
Item Number: 9.506.00



**Photo - Maria Montessori: 4 x 5 in**  
Item Number: 5.690.00



**Photo - Maria Montessori: 8 x 10 in**  
Item Number: 5.691.00



**Photo Of Painting - Maria Montessori: 4 x 5 in**  
Item Number: 5.692.00



**Photo Of Painting - Maria Montessori: 8 x 10 in**  
Item Number: 5.693.00

Photos



Color Photo - Maria Montessori: A4 - 8.3 x 11.7 in  
Item Number: 9.242.00



Color Photo - Maria Montessori: A3 - 11.7 x 16.5 in  
Item Number: 9.246.00

Stickers

Vinyl Sticker: I ♥ Montessori  
Item Number: 9.726.00



Vinyl Sticker: Kids ♥ Montessori  
Item Number: 9.725.00





# Furniture

For over 80 years, Nienhuis has been recognized as a leading manufacturer of high-quality Montessori apparatus and furniture worldwide. In particular, we have consistently focused our vision on producing furniture made of only the finest woods, have taken care that our design is not only perfectly suitable for the children and the needs of the classroom, but also considers our responsibility for the environment as a whole.

With the purchase of Nienhuis by The Heutink Group in 2007, many doors were opened. Not only did we become a member of a high quality, well known, prominent group of companies focused on education, but we were also given access to the specialized companies within this network. Our first collaboration was with Kids-F – a first-rate furniture company. Our teams joined forces and designed a fresh, full line of Montessori furniture and cabinets that we are pleased to present here.

Our chairs and tables were redesigned to comply with the EN 1729 European Standard, which is focused on optimum comfort and posture for the children. The frames and seats of the chairs are made of solid beech wood; the backs are formed of top-quality beech plywood. To facilitate cleaning and long-term durability, the finishes are double-coated lacquer and there is a scratch-resistant coating applied to the tabletops.

Our Material Cabinets are now available in two heights – 69 and 101 cm and there are several styles to choose from. All are extremely versatile; they can stand-alone, or be combined with one or two of our 'End Cabinets' to form a larger configuration and create the perfect combination for your classroom.

In addition to various shelving-only configurations, there are also Material Cabinets with wooden shelves and Gratnells Trays. The Gratnells award-winning educational trays are renowned for their quality, safety, strength and durability. We offer them in two depths (7 cm and 15 cm) in a wide range of colors. This type of storage is effective, efficient and looks good too!

We are sure you will be pleased with our latest additions...



## Chairs

Our chairs are made to endure many years of repeated use. The frames and seats are made of solid beech wood and the backs are formed of top quality beech plywood. They are produced under the strict guidelines of the EN 1729 European Standard; the design is focused on optimum comfort and posture. The finishes are double-coated lacquer to facilitate cleaning and for long-term durability.

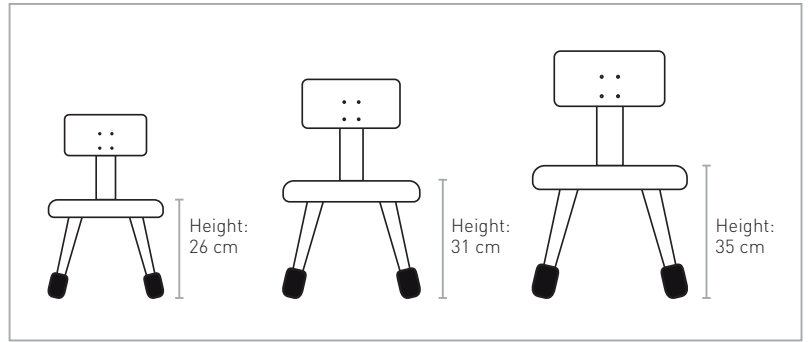

**Chair A1: Orange (26 cm)**  
Item Number: 1.120.00



**Chair B2: Violet (31 cm)**  
Item Number: 1.121.00



**Chair C3: Yellow (35 cm)**  
Item Number: 1.122.00



## Stools

Our stools are made entirely of solid beech wood. They are produced under the strict guidelines of the EN 1729 European Standard; the design is focused on optimum comfort and posture. The finishes are double-coated lacquer to facilitate cleaning and for long-term durability.

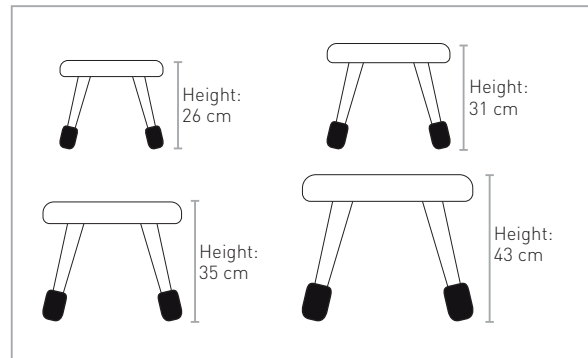

**Stool A1: Orange (26 cm)**

Item Number: 1.130.00



**Stool B2: Violet (31 cm)**

Item Number: 1.131.00



**Stool C3: Yellow (35 cm)**

Item Number: 1.132.00



**Stool E5: Green (43 cm)**

Item Number: 1.135.00



## Tables

Our table frames are made of solid beech wood and are coated with lacquer twice for a beautiful satin finish. The high quality tabletops are coated with a scratch resistant coating for long-term durability. They are produced under the strict guidelines of the EN 1729 European Standard; the design is focused on optimum comfort and posture.

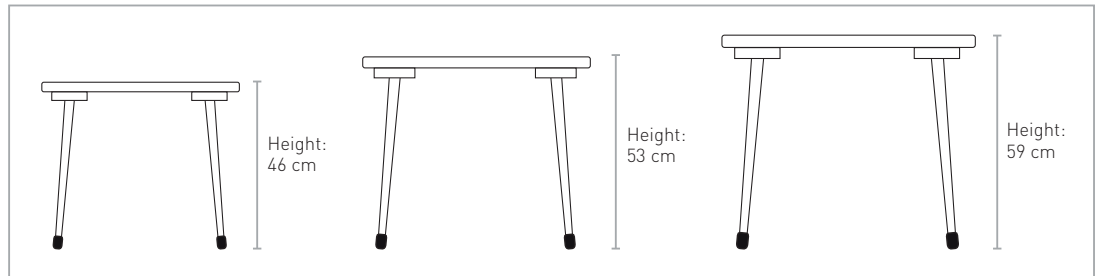

**Table A1: Orange (70 x 50 x 46 cm)**  
Item Number: 1.100.00



**Table B2: Violet (70 x 50 x 53 cm)**  
Item Number: 1.101.00

**Table C3: Yellow (70 x 50 x 59 cm)**  
Item Number: 1.102.00



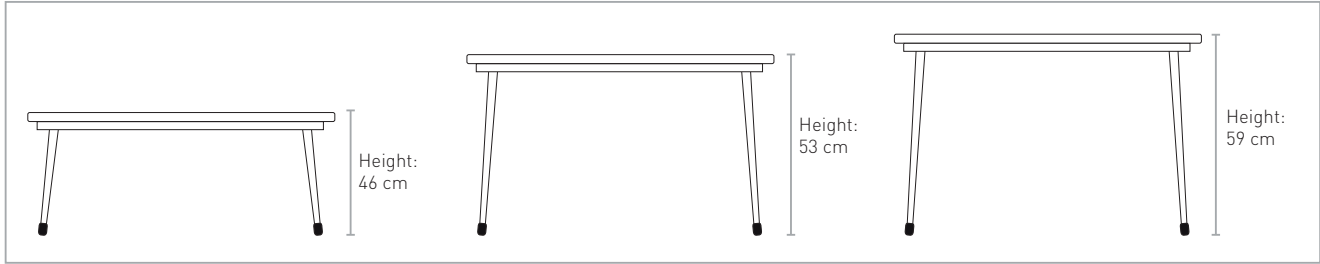

**Group Table A1: Orange (120 x 80 x 46 cm)**  
Item Number: 1.140.00



**Group Table B2: Violet (120 x 80 x 53 cm)**  
Item Number: 1.141.00

**Group Table C3: Yellow (120 x 80 x 59 cm)**  
Item Number: 1.142.00



**Group Table A1: Orange - Round (115 x 46 cm)**  
Item Number: 1.150.00



**Group Table B2: Violet - Round (115 x 53 cm)**  
Item Number: 1.151.00

**Group Table C3: Yellow - Round (115 x 59 cm)**  
Item Number: 1.152.00



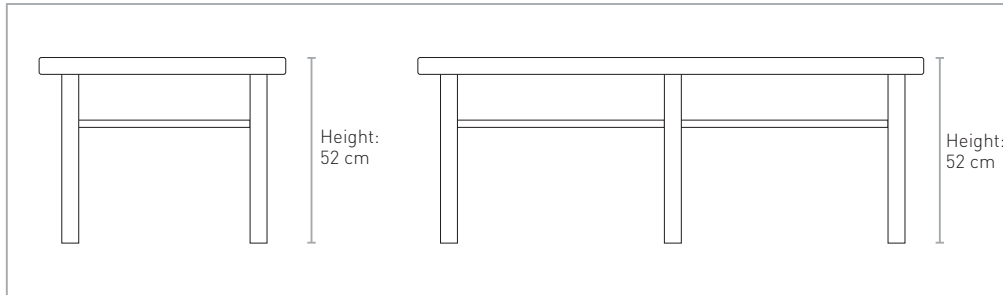

## Hand Washing Table

This table is designed to teach children hand washing. The appropriate size of the table aids in the learning process, as well as promotes independence – ‘they can do it themselves’. The table has two metal bowls: a small one for holding a bar of soap and a larger one for the water. The dimensions are: 68 x 52 x 45 cm. Additional hand washing equipment is not included.

**Item Number: 1.826.00**



## Dish Washing Table

This table is designed to teach children dish washing. The appropriate size of the table aids in the learning process, as well as promotes independence – ‘they can do it themselves’. The table has two metal bowls: one for water, the other for soap. The dimensions are 150 x 52 x 45 cm. Additional dish washing equipment is not included.

**Item Number: 1.825.00**



## Material Cabinets

Our series of newly designed Material Cabinets are for storing Montessori and/or other classroom materials. They may also be used to store the children's shoes, lunches or personal belongings. The open-structure design is enticing to children, which facilitates activity.

They are extremely versatile; they can stand-alone, or be combined with one or two of our 'End Cabinets' to form a larger cabinet configuration. You may mix and match the various styles to create the perfect combination for your classroom.

For your convenience, on the following pages we have grouped the Material Cabinet and End Cabinet variations by height. First the 69 cm styles, then the 101 cm.

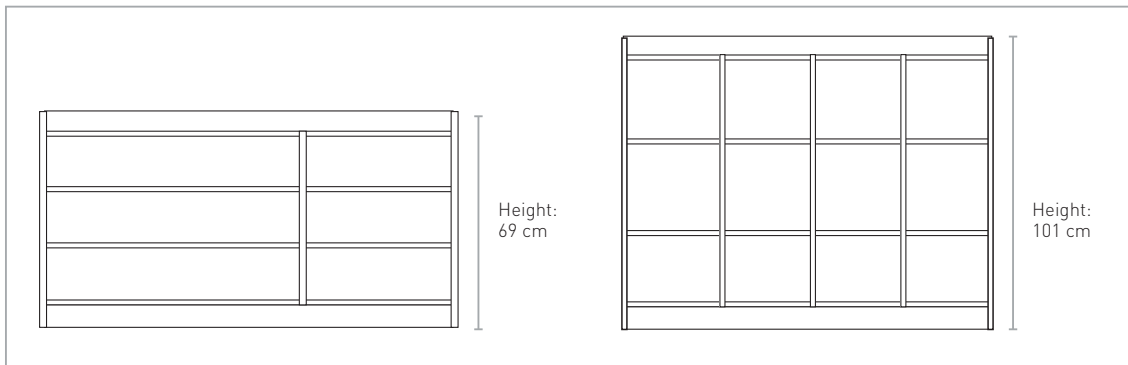

## Material Cabinets - 69 cm



### Material Cabinet: 6 Compartments (69 cm)

A cabinet with 6 compartments. The dimensions are 139 x 69 x 46 cm, which is suitable for children up to 6 years of age.

**Item Number: 1.820.00**



### Material Cabinet: 9 Compartments (69 cm)

A cabinet with 9 compartments. The dimensions are 104 x 69 x 46 cm, which is suitable for children up to 6 years of age.

**Item Number: 1.814.00**



### Material Cabinet: 12 Compartments (69 cm)

A cabinet with 12 compartments. The dimensions are 139 x 69 x 46 cm, which is suitable for children up to 6 years of age.

**Item Number: 1.813.00**



## End Cabinets - 69 cm

The End Cabinets fit perfectly on the end of 2 straight cabinets placed back-to-back. Not only do they provide additional classroom shelving, but they may also be used to divide the various subject areas. The corner cabinets are available in several variations: rounded shelves, tiered shelves, straight shelves or compartments.



### End Cabinet: Tiered Shelves (69 cm)

An End Cabinet with 6 tiered shelves. The dimensions are 92 x 69 x 47 cm, which is suitable for children up to 6 years of age.

**Item Number: 1.811.00**

### End Cabinet: Rounded Shelves (69 cm)

An End Cabinet with 6 rounded shelves. The dimensions are 92 x 69 x 47 cm, which is suitable for children up to 6 years of age.

**Item Number: 1.810.00**



### End Cabinet: 6 Compartments (69 cm)

An End Cabinet with six compartments. The dimensions are 92 x 69 x 47 cm, which is suitable for children up to 6 years of age.

**Item Number: 1.812.00**

## Material Cabinets - 101 cm



### Material Cabinet: 9 Compartments (101 cm)

A cabinet with 9 compartments. The dimensions are 104 x 101 x 46 cm, which is suitable for children from 3 to 12 years of age.

**Item Number: 1.870.00**

### Material Cabinet: 8 Compartments (101 cm)

A cabinet with 8 compartments. The dimensions are 139 x 101 x 46 cm, which is suitable for children from 3 to 12 years of age.

**Item Number: 1.871.00**



### Material Cabinet: 12 Compartments (101 cm)

A cabinet with 12 compartments. The dimensions are 139 x 101 x 46 cm, which is suitable for children from 3 to 12 years of age.

**Item Number: 1.864.00**



## End Cabinets - 101 cm

### End Cabinet: Rounded Shelves (101 cm)

An End Cabinet with 6 rounded shelves. The dimensions are 92 x 101 x 47 cm, which is suitable for children from 3 to 12 years of age.

**Item Number: 1.860.00**



### End Cabinet: Tiered Shelves (101 cm)

An End Cabinet with 6 tiered shelves. The dimensions are 92 x 101 x 47 cm, which is suitable for children from 3 to 12 years of age.

**Item Number: 1.861.00**



## End Cabinet: 6 Compartments (101 cm)

An End Cabinet with 6 compartments. The dimensions are 92 x 101 x 47 cm, which is suitable for children from 3 to 12 years of age.

**Item Number: 1.862.00**



## End Cabinet: 3 Straight Shelves (101 cm)

An End Cabinet with 3 straight shelves. The dimensions are 92 x 101 x 47 cm, which is suitable for children from 3 to 12 years of age.

**Item Number: 1.863.00**



## Book Shelves

Almost every classroom has a reading corner. These Book Shelves are designed just for this purpose. The front of the cabinet has slots for book display while the back side has compartments for material or other storage. These cabinets can be used as a room divider to separate the 'quiet' reading corner from the rest of the classroom.

### Book Shelf: (69 cm)

A Book Shelf with 6 compartments on the back side.  
The dimensions are 104 x 69 x 46 cm, which is suitable for children up to 6 years of age.

**Item Number: 1.821.00**

Front view



Rear view



## Book Shelf: (101 cm)

A Book Shelf with 12 compartments on the back side. The dimensions are 104 x 101 x 46 cm, which is suitable for children from 3 to 12 years of age.

**Item Number: 1.872.00**

Front view



Rear view



## Cabinets With Trays

The series of Cabinets With Trays was designed for many uses: storing classroom materials, children's work, personal belongings, and much more. The cabinet is designed with a safety-stop so the trays don't pull all the way out when in use. However, they can be completely removed by pulling upwards when the tray is fully extended.

These special trays are made by Gratnells - the leading name in school storage products. The cabinets are supplied with the color of the 'Gratnells' trays shown in the photo. It is possible to order an alternate color for an additional fee.

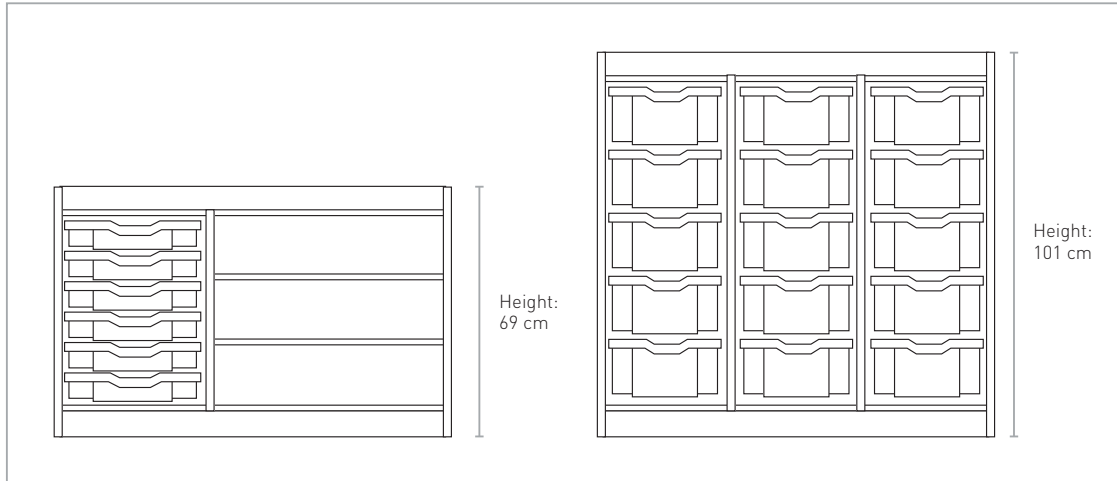

## Cabinets With Trays - 69 cm



### Cabinet: 6 Trays (69 cm)

Cabinet with 6 red 'Gratnells' Trays. The trays have a height of 7 cm and the cabinet is 104 x 69 x 46 cm, which is suitable for children up to 6 years of age.

**Item Number: 1.802.00**



### **Cabinet: 3 Trays (69 cm)**

Cabinet with 3 green 'Gratnells' Trays. The trays have a height of 15 cm and the cabinet is 104 x 69 x 46 cm, which is suitable for children up to 6 years of age.

**Item Number: 1.803.00**



### **Cabinet: 9 Trays (69 cm)**

Cabinet with 9 yellow 'Gratnells' Trays. The trays have a height of 15 cm and the cabinet is 104 x 69 x 46 cm, which is suitable for children up to 6 years of age.

**Item Number: 1.801.00**



### **Cabinet: 18 Trays (69 cm)**

Cabinet with 18 blue 'Gratnells' Trays. The trays have a height of 7 cm and the cabinet is 104 x 69 x 46 cm, which is suitable for children up to 6 years of age.

**Item Number: 1.800.00**





## Cabinets With Trays - 101 cm



### **Cabinet: 10 Trays (101 cm)**

Cabinet with 10 red 'Gratnells' Trays. The trays have a height of 7 cm and the cabinet is 104 x 101 x 46 cm, which is suitable for children from 3 to 12 years of age.

**Item Number: 1.852.00**



### **Cabinet: 5 Trays (101 cm)**

Cabinet with 5 green 'Gratnells' Trays. The trays have a height of 15 cm and the cabinet is 104 x 101 x 46 cm, which is suitable for children from 3 to 12 years of age.

**Item Number: 1.853.00**



## **Cabinet: 30 Trays (101 cm)**

Cabinet with 30 blue 'Gratnells' Trays. The trays have a height of 7 cm and the cabinet is 104 x 101 x 46 cm, which is suitable for children from 3 to 12 years of age.

**Item Number: 1.850.00**



## **Cabinet: 15 Trays (101 cm)**

Cabinet with 15 yellow 'Gratnells' Trays. The trays have a height of 15 cm and the cabinet is 104 x 101 x 46 cm, which is suitable for children from 3 to 12 years of age.

**Item Number: 1.851.00**

## Gratnells Trays



**Gratnells Tray: Yellow (7 cm)**  
Item Number: 1.890.00



**Gratnells Tray: Red (7 cm)**  
Item Number: 1.890.01



**Gratnells Tray: Blue (7 cm)**  
Item Number: 1.890.02



**Gratnells Tray: Brown (7 cm)**  
Item Number: 1.890.03



**Gratnells Tray: Green (7 cm)**  
Item Number: 1.890.04



**Gratnells Tray: Transparent (7 cm)**  
Item Number: 1.890.05



**Gratnells Tray: Yellow (15 cm)**  
Item Number: 1.895.01



**Gratnells Tray: Red (15 cm)**  
Item Number: 1.895.02



**Gratnells Tray: Blue (15 cm)**  
Item Number: 1.895.03



**Gratnells Tray: Brown (15 cm)**  
Item Number: 1.895.04



**Gratnells Tray: Green (15 cm)**  
Item Number: 1.895.05



**Gratnells Tray: Transparent (15 cm)**  
Item Number: 1.895.06

### Sensorial Cabinet (101 cm)

A cabinet designed to store and/or display the sensorial materials.  
The dimensions are 138 x 101 x 46 cm, which is suitable for children from 3 to 12 years of age.

**Item Number: 1.855.00**



## Geometry/Biology Cabinet (69 cm)

A cabinet designed to store all the basic geometry or biology material. The dimensions are 53 x 69 x 46 cm, which is suitable for children up to 6 years of age.

**Item Number: 1.822.00**



## Geometry/Biology Cabinet (101 cm)

A cabinet designed to store and/or display the basic geometry or biology material. The dimensions are 53 x 101 x 46 cm, which is suitable for children from 3 to 12 years of age.

**Item Number: 1.875.00**

### The Complete Practical Life Stand

Set includes: 1 shoe polishing set, 1 small dusting brush, 1 indoor broom: soft black, 1 rug beater, 1 dust pan, 1 dust brush with handle, 1 scrubber and 1 squeegee.

**Item Number: 1.727.00**



### Dressing Frames Stand

The Dressing Frames Stand is freestanding to occupy minimum floor space while allowing the child easy access to the 12 Dressing Frames.

**Item Number: 1.632.00**



### The Farm Table

This specially designed beech plywood stand with a storage shelf serves as support for The Farm. Measures 76 x 60 x 45 cm.

**Item Number: 1.725.00**



### Wall Frame For The Metal Insets

A beech plywood wall frame for holding The Metal Insets and other materials used in the exercise. 77 x 75 x 23 cm.

**Item Number: 1.730.00**



### Stand For Greenboards

Stand holds 10 boards with a top shelf for storing chalk, erasers and paper. 34 x 62 x 37 cm.

**Item Number: 1.735.00**



**Stand For Cylinder Blocks**  
Item Number: 1.900.00



**Bead Material Cabinet**

This cabinet is designed to display the Bead Material. 95 x 120 x 14 cm.

**Item Number: 1.760.00**

## Stand For 3 Carpets

This durable beech plywood stand stores the carpets neatly and makes them easily accessible to the child. 57 x 62 x 23 cm.

**Item Number: 1.731.00**



## Stand For 5 Carpets

This durable beech plywood stand stores the carpets neatly and makes them easily accessible to the child. 89 x 62 x 23 cm.

**Item Number: 1.732.00**





### **Puzzle Map Cabinet**

A beech plywood cabinet that stores 12 Puzzle Maps.  
61 x 62 x 47 cm.

**Item Number: 1.740.00**

### **Puzzle Map Stand**

This beechwood stand holds up to 8 puzzle maps and is designed for efficient storage. 65 x 70 x 55 cm.

**Item Number: 0.176.A0**



### **Cabinet For Paper Map**

A wooden cabinet with 6 shelves used for storing Paper Maps (maps not included).

**Item Number: 1.626.00**

## Music And Art Furniture

Nienhuis has designed furniture specifically for music and the arts. This furniture is adjustable in height for use by children of differing age levels.

### Bell Cabinet

This cabinet is adjustable in height and is used for working with both The Bells And The Tone Bars. The dimensions are 145 x 58.5/68 x 40 cm.

**Item Number: 1.910.00**

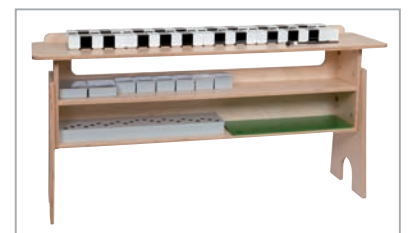

### Tone Bar Cabinet

This cabinet is adjustable in height and is used for working with both The Bells And The Tone Bars. The dimensions are 145 x 58.5/68 x 40 cm.

**Item Number: 1.910.00**

### **Easel: 2 Boards**

The 2 Board Easel is sturdy and adjustable in height. The design allows 2 children to work simultaneously - 1 on each side. The paper is attached using clamps, tape or other means (not included). For canvas use, we suggest resting the canvas on the tray. 55 x 142 x 59 cm.

**Item Number: 1.877.00**



## Easel: 4 Boards

The 4 Board Easel is sturdy and is adjustable in height. The design allows 4 children to work simultaneously - 2 on each side. The paper is attached using clamps, tape or other means (not included). For canvas use, we suggest resting the canvas on the tray. 105 x 142 x 59 cm.

**Item Number: 1.876.00**





HARIA MONTESSORI  
**WHAT YOU SHOULD KNOW ABOUT YOUR CHILD**  
EDUCATION

EDUCATE THE HUMAN POTENTIAL  
THE CLIO MONTESSORI SERIES  
I Know What Gravity Does  
Who Make Silence

EDUCATION AND PEACE  
THE CLIO MONTESSORI SERIES  
Maria Montessori

EDUCATION FOR DEVELOPING CHILDREN  
THE CLIO MONTESSORI SERIES  
A PARENTS GUIDE TO  
LESLAY BRITTON  
**MONTESSORI PLAY AND LEARN**  
WITH AN INTRODUCTION BY JOY STARRETT  
PRESIDENT OF THE MONTESORI EDUCATION AND EDITOR OF MONTESORI LIFE MAGAZINE  
PURPOSEFUL PLAY

MONTESSORI  
A Modern Approach  
PAULA POLK LILLARD

Montessori Home  
A parent's guide to the home environment

I Offer You Peace  
My Ships  
Nienhuis  
MONTESORI

REVISED AND UPDATED  
**THE ESSENTIAL MONTESSORI**  
An Introduction to the Woman, the Writings, the Method, and the Movement  
ELIZABETH G. HAINSTOCK  
Presented by Lee Hays

How Big Is The Milky Way?  
A parent's guide to the home environment

MONTESSORI  
THE SCIENCE BEHIND THE GENIUS  
STOLL LILLARD  
by An Vu

OR LEARNING THE NAMES OF THE ARTISTS  
Nienhuis  
MONTESORI

**Understanding the Human Being**  
The Importance of the First Three Years of Life  
Silvana Quattrocchi Montanaro, M.D.

how to raise an **AMAZING CHILD**  
THE MONTESSORI WAY  
TIM SELDIN  
President  
Montessori Foundation

**MONTESSORI FROM THE START**  
The Child at Home, from Birth to Age Three  
PAULA POLK LILLARD AND LYNN LILLARD JESSEN

Montessori  
Sensorial Exploration

cultivar el espíritu en un ambiente latente  
por ALINE D. WOLF  
Dibujos por Joe Servello

I Travel on Planet Earth

ori  
ng  
e  
nt  
A Guide for Parents & Teachers  
MONTESORI  
DR. MONTESSORI'S OWN HANDBOOK  
A Short Guide to Her Ideas and Materials

THE MONTESSORI SERIES  
VOLUME 16  
**Psychogeometry**  
Maria Montessori

THE ABSORBENT MIND  
THE CLIO MONTESSORI SERIES

The  
of

# Books

As a leading manufacturer and supplier of Montessori materials, we strive to make a valuable contribution to Montessori education.

Our philosophy is to not only supply the finest Montessori educational materials, but to also support the Montessori community as a whole by offering an extensive range of exceptional Montessori Books, Publications and DVD's

All of Dr. Montessori's writings are available, as well as a large assortment of books: For Parents, For Teachers, About Dr. Montessori... There are a few new books, as well as a comprehensive selection of DVD's and Reference Books for your pleasure.



## By Dr. Maria Montessori

Note: books from Kalakshetra Press contain translations that may be somewhat different from the Clio series books.

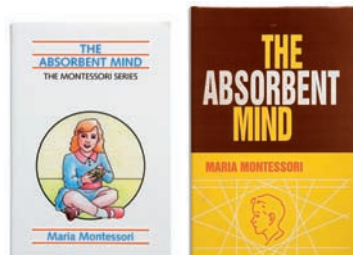

### The Absorbent Mind

Dealing comprehensively with the construction of the human personality, and the nature of learning, this book propounds Dr. Montessori's revolutionary ideas about education as an aid to life. In this book Dr. Montessori indicates the responsibility of adult humanity towards this fundamental period of man's self-formation.

- Clio: 270 pp, soft cover, 1997 edition.

**Item Number: 5.460.00**

- Kalakshetra: 308 pp, hard cover, 2002 edition.

**Item Number: 5.483.00**

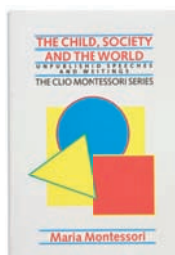

### The Child, Society And The World

Speeches and lectures written by Maria Montessori on peace, environmental awareness and universal responsibility.

- Clio: 126 pp, soft cover, 1998 edition.

**Item Number: 5.345.00**



### The Child In The Family

In this book Dr. Montessori examines the tensions inherent in the relationship between the adult and the child. She discusses the difficulties and contradictions of daily life within the frame work of which adults need to recognize and rectify their own defects in order to become worthy of the child. She stresses the importance of the child's environment and the role it plays in the building of the child's character.

- Clio: 75 pp, soft cover, 2007 edition.

**Item Number: 5.468.00**

- Kalakshetra: 126 pp, hard cover, 1991 edition.

**Item Number: 5.491.00**

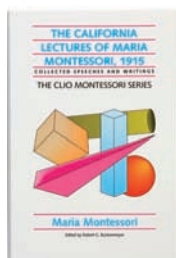

### The California Lectures Of Maria Montessori - 1915

This edition includes many unpublished lectures and articles by Maria Montessori during her 1915 attendance at the Panama Pacific Exposition in San Francisco.

- Clio: 375 pp, soft cover, 1997 edition.

**Item Number: 5.473.00**

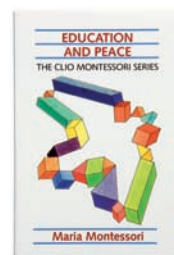

### Education And Peace

Collected together in this book are those public addresses, in which Dr. Montessori first came to grips with the problem of the future of humanity, and gave passionate expression to her insight on the form education must take to be able to help the world in its present circumstances.

- Clio: 119 pp, soft cover, 1997 edition.

**Item Number: 5.467.00**

- Kalakshetra: 159 pp, hard cover, 1972 edition.

**Item Number: 5.492.00**

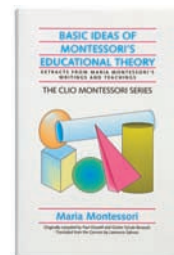

### Basic Ideas Of Montessori's Educational Theory

Excerpts from her writings and teachings provide a lively analysis of Maria Montessori's educational beliefs and methodology.

- Clio: 208 pp, soft cover, 1998 edition.

**Item Number: 5.472.00**

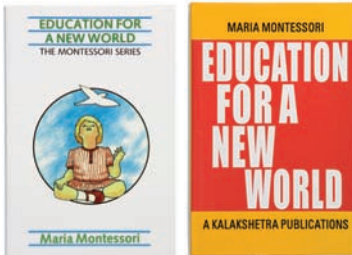

## Education For A New World

Meant for the parents and teachers of children under age 6. Taking into account the biological and psychological aspects of child development, the Montessori approach urges adults towards a new outlook from which childcare will change from drudgery and repression, to joyous collaboration with nature.

- Clío: 69 pp, soft cover, 1999 edition.

**Item Number: 5.462.00**

- Kalakshetra: 97 pp, hard cover, 1991 edition.

**Item Number: 5.480.00**



## The Advanced Montessori Method: Volume 1 And Volume 2

This work on scientific pedagogy comes in two volumes. The first volume entitled "Spontaneous Activity In Education" begins with a survey of the inner and outer life of the child, and emphasizes the importance of the prepared environment in education. The second volume is entitled "The Montessori Elementary Materials". The two volumes discuss the application of the Montessori principles in the education of older children between 7 and 11 years of age.

### Volume 1

- Clío: 273 pp, soft cover, 2002 edition.

**Item Number: 5.469.00**

- Kalakshetra: 294 pp, hard cover, 1988 edition.

**Item Number: 5.486.00**



### Volume 2

- Clío: 406 pp, soft cover, 1999 edition.

**Item Number: 5.470.00**

- Kalakshetra: 421 pp, hard cover, 1996 edition.

**Item Number: 5.487.00**

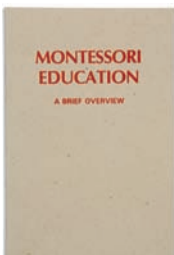

## Montessori Education

A distillation of the Montessori Method including the results of some of Dr. Montessori's experiments and touches on the practical requirements of a Montessori environment.

- Kalakshetra: 18 pp, soft cover, 1997 edition.

**Item Number: 5.490.00**

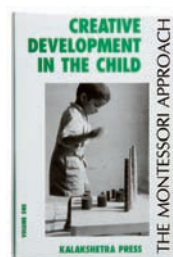

## Creative Development In The Child: Volume 1 And Volume 2

Based on Dr. Montessori's lectures during her first course in India in 1939. This book, in two volumes, explores the Montessori approach to the education of children between 3 and 6 years of age.

### Volume 1

- Kalakshetra: 249 pp, hard cover, 1994 edition.

**Item Number: 5.494.00**



### Volume 2

- Kalakshetra: 320 pp, hard cover, 1998 edition.

**Item Number: 5.495.00**

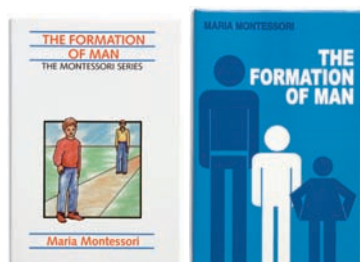

### The Formation Of Man

In this book, Dr. Montessori urges adults towards an understanding of the laws of growth, and pleads for a reshaping of the educational system that is ironically prejudiced against the child. First printed in 1955, the book includes a chapter on world illiteracy, as it is a problem of grave magnitude, even today.

- Clio: 99 pp, soft cover, 1996 edition.

**Item Number: 5.464.00**

- Kalakshetra: 137 pp, hard cover, 1991 edition.

**Item Number: 5.488.00**

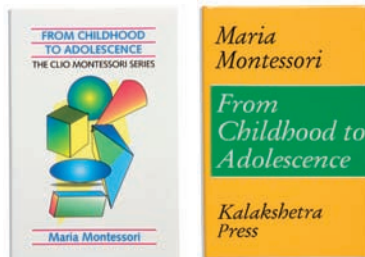

### From Childhood To Adolescence

This work follows the child from the age of 7 through adolescence. Dr. Montessori's understanding of the adolescent's need for independence in thought and action is remarkable. Her comments on the state of education and its implications for the world at large are very modern and more relevant today than ever before.

- Clio: 100 pp, soft cover, 1999 edition.

**Item Number: 5.471.00**

- Kalakshetra: 151 pp, hard cover, 1973 edition.

**Item Number: 5.493.00**



### To Educate The Human Potential

A more comprehensive study of child development, this book is a companion volume to "Education For A New World". While unfolding before us the history of the world, and the history of human development, Dr. Montessori places her wide-spectrum approach to education in the modern context.

- Clio: 85 pp, soft cover, 1996 edition.

**Item Number: 5.463.00**

- Kalakshetra: 126 pp, hard cover, 1991 edition.

**Item Number: 5.481.00**



### The Montessori Method

Theory and practice of the "Casa Dei Bambini." Shows parents, teachers and administrators how to "free a child to learn through his own efforts".

- Schocken: 376 pp, soft cover, 1964 edition.

**Item Number: 5.334.00**



### Dr. Montessori's Own Handbook

Dr. Montessori's notes as to the use and intent of Montessori curriculum tools.

- Schocken: 189 pp, soft cover, 1965 edition.

**Item Number: 5.332.00**

## By Dr. Maria Montessori



### The Discovery Of The Child

First published in 1948, this book lucidly delineates the fundamental principles of the Montessori approach to education, which was based on a series of genuine discoveries of Dr. Maria Montessori. The application of these principles, transcends boundaries of class, culture or creed, and is relevant to the whole of human development.

- Clío: 339 pp, soft cover, 2002 edition.

**Item Number: 5.461.00**

- Kalakshetra: 360 pp, hard cover, 2006 edition.

**Item Number: 5.482.00**

- Ballantine: 339 pp, soft cover, 1972 edition.

**Item Number: 5.400.00**



### What You Should Know About Your Child

A valuable guide for parents, this book is based on the lectures delivered by Dr. Montessori. It simplifies her great educational principles, and brings them within easy reach of the lay person.

- Clío: 99 pp, soft cover, 1998 edition.

**Item Number: 5.465.00**

- Kalakshetra: 117 pp, hard cover, 1993 edition.

**Item Number: 5.485.00**



### The Secret Of Childhood

At the turn of the century, in a poor quarter of Rome, in the very first House of Children (Casa dei Bambini), a few slum children revealed to Dr. Montessori the spiritual grandeur of the human spirit. From the intensely poetic and philosophical, to the simple truths based on scientific observation, this book has inspired thousands and captures the thrilling moments of the early days of the Montessori movement.

- Ballantine: 216 pp, soft cover, 1972 edition.

**Item Number: 5.399.00**

- Kalakshetra: 234 pp, hard cover, 2005 edition.

**Item Number: 5.489.00**



### Child Education

This slim volume is a collection of Dr. Montessori's series of talks on All India Radio, during her sojourn in India. The book encompasses the quintessential Montessori philosophy, and is an invaluable handbook for those who wish for an introduction to her ideas.

- Kalakshetra: 60 pp, soft cover.

**Item Number: 5.484.00**

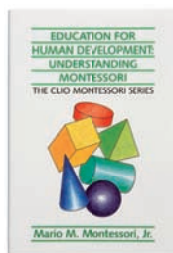

**Education For Human Development**

Mario M. Montessori, Jr. An insight into his grandmother’s personality, her role as a feminist and her philosophy of education and child growth.

- Clio: 117 pp, soft cover, 1997 edition.

**Item Number: 5.319.00**

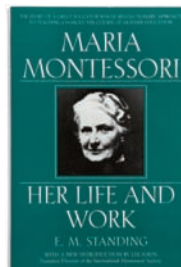

**Maria Montessori: Her Life And Work**

E. M. Standing. Introduction by John J. McDermott. A biography that includes quotes from her letters and diaries.

- 380 pp, soft cover, 1998 edition.

**Item Number: 5.397.00**

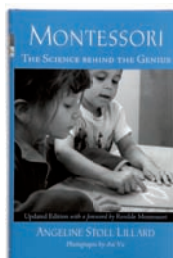

**Montessori: The Science Behind The Genius**

Angeline Stoll Lillard. Research supporting the eight insights that are the foundation of Montessori education. In reading this book, parents and teachers alike will develop a clear understanding of what happens in a Montessori classroom, why it happens and why it works.

- 404 pp, soft cover, 2007 edition.

**Item Number: 5.323.00**

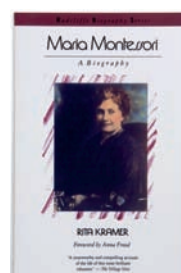

**Maria Montessori**

Rita Kramer. This biography covers the personal life of Dr. Montessori and the intellectual and social climate of Italy during her formative years.

- 410 pp, soft cover, 1988 edition.

**Item Number: 5.406.00**



**Maria Montessori 100 Years: 1907 - 2007 Centenary Of The Montessori Movement**

Includes photos and a history of the ‘movement’.

- Kalekshetra: 221 pp, hard cover, 2007 edition.

**Item Number: 5.496.00**

## About Dr. Maria Montessori



### Psychogeometry: Hard Cover

Maria Montessori. 'Psychogeometry' demonstrates the originality and brilliance of Maria Montessori's own mathematical talents. This, combined with her deep understanding of the psychological workings of the child's mind, enabled her to offer an approach to mathematics that is irresistible and fascinating. Based on her Italian manuscript and the 1934 Spanish edition.

- 233 pp, hard cover, 2011 edition, Volume 16.

**Item Number: 5.475.00**

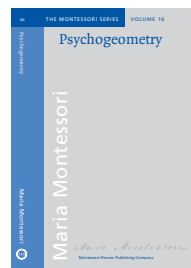

### Psychogeometry: Soft Cover

Maria Montessori. 'Psychogeometry' demonstrates the originality and brilliance of Maria Montessori's own mathematical talents. This, combined with her deep understanding of the psychological workings of the child's mind, enabled her to offer an approach to mathematics that is irresistible and fascinating. Based on her Italian manuscript and the 1934 Spanish edition.

- 233 pp, soft cover, 2011 edition, Volume 16.

**Item Number: 5.476.00**

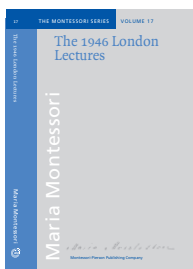

### The 1946 London Lectures

Maria Montessori. The 1946 London course was the first course given in Europe by Maria Montessori after she and her son Mario returned from seven years of exile in India. This course was to have significant pedagogical consequences, since 'The 1946 London Lectures' became the foundation of AMI's 3-6 courses.

- 264 pp, soft cover, 2012 edition, Volume 17.

**Item Number: 5.477.00**

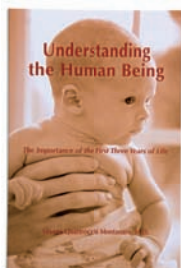

**Understanding The Human Being**

Silvana Montanaro, MD. The importance of education in the first 3 years of life to reach a high level of emotional, intellectual and moral integration.

- 166 pp, soft cover, 1991 edition.

**Item Number: 5.315.00**



**How To Raise An Amazing Child**

Tim Seldin. Practical suggestions about building a calm and happy home life with your child, from birth through age 6.

- 192 pp, soft cover, 2006 edition.

**Item Number: 5.454.00**



**The Montessori Way**

Tim Seldin and Paul Epstein, Ph.D. A comprehensive introduction to the philosophy and approach practiced in Montessori schools. For parents, educators and anyone looking for an explanation of Montessori education.

- 272 pp, soft cover, 2006 edition.

**Item Number: 5.455.00**

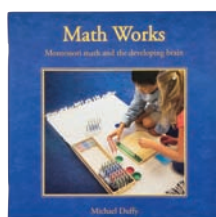

**Math Works: Montessori Math And The Developing Brain**

Michael Duffy. A book that gives parents an insight into the Montessori math materials. The benefits, how they affect the growth of the child's brain and how they prepare him for the future. Includes photos of children using the materials.

- 78 pp, soft cover, 2008 edition.

**Item Number: 5.415.00**



**Montessori Madness**

Trevor Eissler. The author uses lots of personal anecdotes and examples from his observations in a Montessori classroom to explain the Montessori principles and how they are used in Montessori education. Recommended for any parent interested in or wondering about Montessori.

- 242 pp, soft cover, 2009 edition.

**Item Number: 5.327.00**

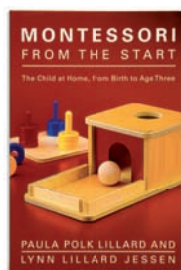

**Montessori From The Start: The Child At Home From Birth To Age Three**

Paula Polk Lillard and Lynn Lillard Jessen. The authors provide parental guidance for the establishment of an environment to aid in the development of focus and concentration.

- 259 pp, soft cover, 2003 edition.

**Item Number: 5.322.00**

## For Parents

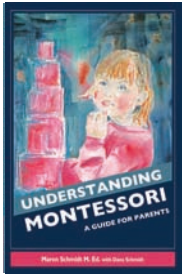

### Understanding Montessori: A Guide for Parents

Maren Schmidt. Understanding Montessori: A Guide For Parents helps parents understand the stages of childhood growth and learning and how Montessori education uniquely meets each child's learning needs.

- 272 pp, soft cover, 2009 edition.

**Item Number: 5.329.00**

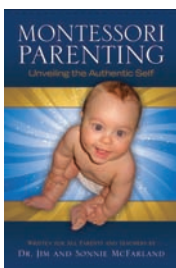

### Montessori Parenting

Sonnie McFarland. Montessori Parenting: Unveiling The Authentic Self is a must read for all parents and teachers of young children. The reader learns how to: Implement Montessori philosophy in the home, constructively respond to children's behavior, be calm and confident with children, enhance children's authentic nature, and much more.

- 294 pp, soft cover, 2011 edition.

**Item Number: 5.497.00**

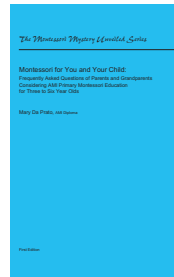

### Montessori For You and Your Child

Mary Da Prato. Have you ever wondered what Montessori is? Many of us have heard the name "Montessori" but do not know what Montessori teaches. Montessori for You and Your Child is a practical question and answer format book that unveils the mystery of the Montessori Method so families can make an informed choice for their children.

- 102 pp, soft cover, first edition, 2011.

**Item Number: 5.328.00**

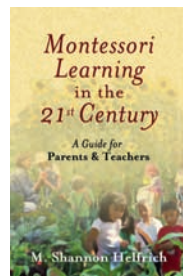

### Montessori Learning in the 21st Century: A Guide for Parents & Teachers

M. Shannon Helfrich. This book fills a growing demand for contemporary books on Montessori education and how it applies to childhood learning and education in the 21st Century. This book confirms Dr. Montessori's pivotal role in the history of childhood education internationally.

- 204 pp, soft cover, 2011 edition.

**Item Number: 5.330.00**





### In A Montessori Home

Sarah Moudry. NAMTA. Based on Montessori principles. Ideas, and valuable information to help parent's in preparing the home for children from birth to 3 years. Includes beautiful photographs taken at 'real' homes and a parent resource guide at the end gives guidance for choosing and finding toys, clothing and furniture consistent with Montessori principles.

- 36 pp, soft cover, 2008 edition.

**Item Number: 5.360.00**



### At Home With Montessori

Patricia Oriti, Edited by David Kahn. An illustrated approach of how adults and children can live together harmoniously while maintaining different goals for development.

- 27 pp, soft cover, 1994 edition.

**Item Number: 5.361.00**



### What Is Montessori Preschool?

David Kahn. The Montessori Method as applied to the preschool classroom.

- 23 pp, soft cover, 1995 edition.

**Item Number: 5.361.10**

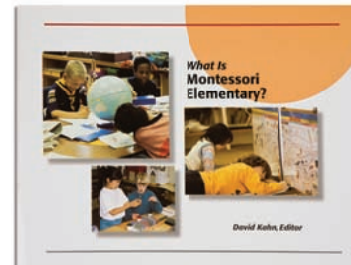

### What Is Montessori Elementary?

David Kahn. The Montessori method as applied to the elementary classroom.

- 17 pp, soft cover, 1995 edition.

**Item Number: 5.361.20**

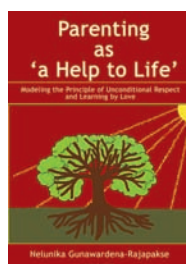

### Parenting As A Help to Life

Nelunika Gunawardena-Rajapakse. Parenting As A Help To Life is an exposition of one world citizen's well-lived educational wisdom. Pointers and information contained in this book will help all parents build the foundation for their children 'that is a help to life' one of - patience, peace, compassion and love.

- 447 pp, soft cover, 2008 edition.

**Item Number: 5.390.00**

## For Parents

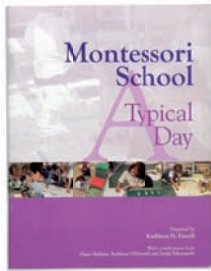

### Montessori School: A Typical Day

Kathleen Futrell. This book answers basic questions for parents and allows them to understand the 'preparation for life' their children experience in a Montessori school. Originally written for parents at The Aquinas Montessori Children's House in Virginia.

- 31 pp, soft cover, 2005 edition.

**Item Number: 5.392.00**



### Our Peaceful Classroom

Aline D. Wolf. This book is compiled of 64 drawings by Montessori children world-wide.

- 64 pp, soft cover, 1991 edition.

**Item Number: 5.430.10**

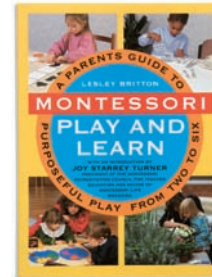

### Montessori Play And Learn

Leslie Britton, Introduction by Joy Turner. Activities, ideas and games that can supplement preschool learning for the child.

- 144 pp, soft cover, 1992 edition.

**Item Number: 5.401.00**

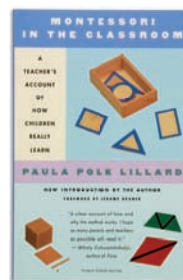

### Montessori In The Classroom

Paula Polk Lillard. A fascinating day-by-day record of a year in the life of a Montessori classroom. A glimpse of the Montessori method in action.

- 266 pp, soft cover, 1997 edition.

**Item Number: 5.321.00**



### Montessori: A Modern Approach

Paula Polk Lillard. A historical, philosophical and practical guide to the Montessori curriculum.

- 174 pp, soft cover, 1972 edition.

**Item Number: 5.320.00**

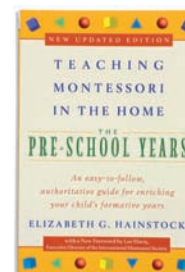

### Teaching Montessori In The Home: The Pre-School Years

Elizabeth G. Hainstock. A guide for parents to introduce the Montessori method at home.

- 115 pp, soft cover, 1997 edition.

**Item Number: 5.394.00**

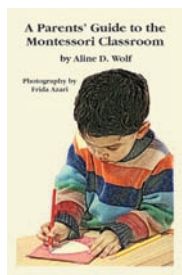

### A Parent's Guide To The Montessori Classroom

Aline D. Wolf. Describes the Montessori program for children between the ages of 3 and 6.

- 61 pp, soft cover, 2009 edition.

**Item Number: 5.380.00**



### A Parent's Guide To The Montessori Classroom: Spanish Edition

- 61 pp, soft cover, 2011 edition.

**Item Number: 5.450.00**

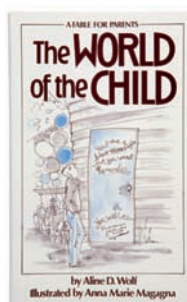

### The World Of The Child

Aline D. Wolf. Illustrated by Anna Maria Magagna. The father, frustrated with parenting, is taken to the world of the child where he re-experiences the frustrations of a toddler.

- 52 pp, soft cover, 1982 edition.

**Item Number: 5.430.00**

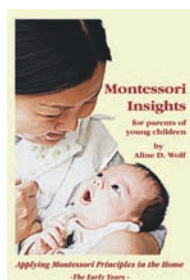

### Montessori Insights: For Parents Of Young Children

Aline D. Wolf. A collection of 'insights' for parents of Maria Montessori's principles and suggestions of how to apply them.

- 52 pp, soft cover, 2005 edition.

**Item Number: 5.382.00**

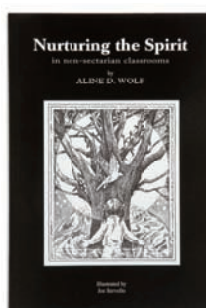

### Nurturing The Spirit

Aline D. Wolf. Illustrated by Joe Servello. This book was written for Montessori teachers. Many readers believe that it can be useful for parents or teachers who want to include the spiritual dimension in their care of young children.

- 194 pp, soft cover, 1996 edition.

**Item Number: 5.384.10**

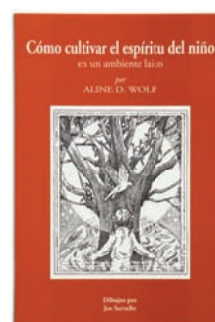

### Nurturing The Spirit: Spanish Edition

- 157 pp, soft cover, 1999 edition.

**Item Number: 5.385.00**

## For Parents

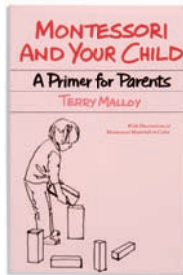

### Montessori And Your Child: A Primer For Parents

Terry Malloy. A handbook for parents of young children, 3 to 6 years of age, to help them understand and assist in the growth of their child.

- 92 pp, soft cover, 1974 edition.

**Item Number: 5.326.00**

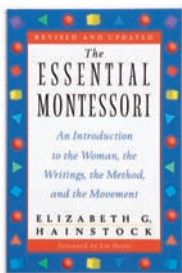

### The Essential Montessori

Elizabeth G. Hainstock. An introductory source for the newcomer to Montessori. Includes a directory of information sources.

- 140 pp, soft cover, 1997 edition.

**Item Number: 5.396.00**



### Montessori Today

Paula Polk Lillard. Montessori theory and practice, with special emphasis on the child's elementary school years. For parents, teachers, and all those who are concerned about education today.

- 207 pp, soft cover, 1996 edition.

**Item Number: 5.320.10**



### Look At The Child

Aline D. Wolf. Excerpts from Maria Montessori's writings with photographs of young children in everyday situations.

- 64 pp, soft cover, 1978 edition.

**Item Number: 5.413.00**

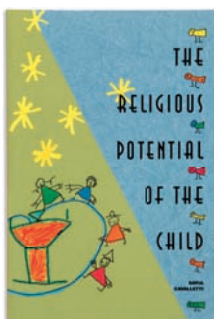

### The Religious Potential Of The Child

Sophia Cavalletti. Describes an experience of adults and children dwelling together in the mystery of God.

- 251 pp, soft cover, 1992 edition.

**Item Number: 5.374.00**



### Maria Montessori Farmschool Erdkinder

Ursula Thrush. The story of the Maria Montessori Farmschool, an Erdkinder experiment, to educate youth between the ages of 12-18.

- 56 pp, soft cover, 1982 edition.

**Item Number: 5.434.00**

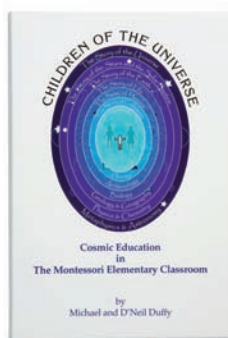

### Children Of The Universe

Michael & D'Neil Duffy. Cosmic Education introduces elementary age children to the universal values that can save us from wars and planetary destruction.

- 197 pp, soft cover, 2002 edition.

**Item Number: 5.418.00**

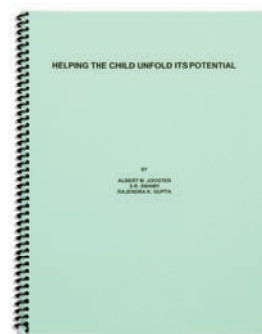

### Helping The Child Unfold Its Potential

Albert M. Joosten, S.F. Swamy, Rajendra K. Gupta. The authors present insightful thoughts and observations regarding early childhood development according to the discoveries of Dr. Montessori.

- 75 pp, soft cover, 2003 edition.

**Item Number: 5.364.00**



### The Hidden Hinge

Rosa Packard. Examines the nature of children and the role of adults in encouraging their learning.

- 229 pp, soft cover, 1995 edition.

**Item Number: 5.411.00**

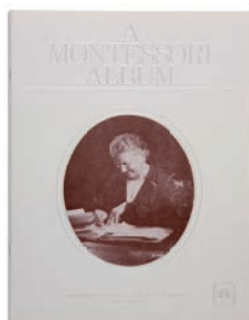

### A Montessori Album

Margot R. Waltuch. Margot Waltuch is one of the few people who knew and worked with Maria Montessori. Her album provides personal insights and presents the Montessori method in the context of international history.

- 27 pp, soft cover, 1986 edition.

**Item Number: 5.357.00**



### Montessori Read & Write

Lynne Lawrence. Brings the benefits of the Montessori system within reach of all parents. Packed with ideas, activities and games that make learning easy.

- 160 pp, soft cover, 1998 edition.

**Item Number: 5.368.00**

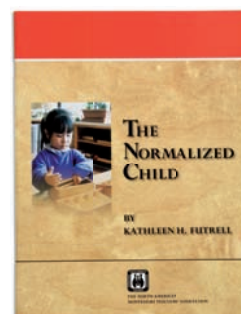

### The Normalized Child

Kathleen H. Futrell. Excerpts from a talk given to parents of the children at The Aquinas Montessori School (Virginia) in 1966. This booklet has enjoyed widespread use by many Montessori schools and organizations. Nicely illustrated with full-color photographs of children at work.

- 28 pp, soft cover, 1998 edition, reprinted by NAMTA

**Item Number: 5.393.00**

## For The Teacher

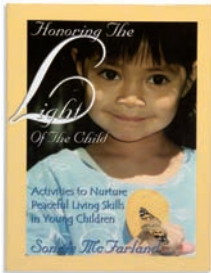

### Honoring The Light Of The Child

Sonnie McFarland. Provides practical and imaginative ways to help children recognize and experience their love lights and become responsible global citizens. Includes a music CD by Pat Yokel.

- 123 pp, soft cover, 2010 edition.

**Item Number: 5.435.00**

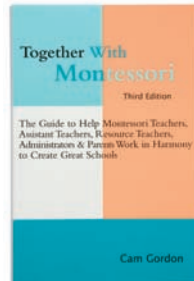

### Together With Montessori

Cam Gordon. A guide to help Montessori teachers, administrators and parents work in harmony to create great schools.

- 94 pp, soft cover, 2007 edition.

**Item Number: 5.410.00**

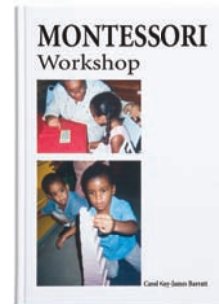

### Montessori Workshop

Carol Guy-James Barratt. Written to accompany and improve the practical formation of Montessori preschool teachers working with children 2 to 6 years of age. The book also facilitates parents' comprehension of their children's activities with Montessori material.

- 281 pp, hard cover, 2007 edition.

**Item Number: 5.176.00**

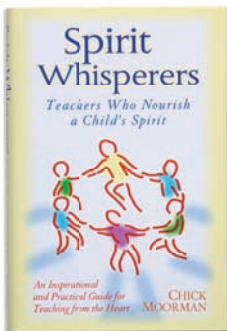

### Spirit Whisperers: Teachers Who Nourish A Child's Spirit

Chick Moorman. A beautiful book that encourages and honors those who bring in the human side to their teaching methods. An inspirational and practical guide for teaching from the heart.

- 220 pp, hard cover, 2001 edition.

**Item Number: 5.375.00**



### The World In The Palm Of Her Hand

Tim Seldin. Second and revised edition. Introduction to curriculum for physical and cultural geography, mapping and history. Includes material not in the original edition. The Montessori Foundation.

- 160 pp, soft cover, 2004 edition.

**Item Number: 5.456.00**

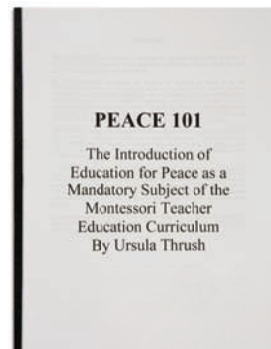

### Peace 101

Ursula Thrush. The introduction of 'Education for Peace' as a mandatory subject of the Montessori teacher-education curriculum.

- 38 pp, soft cover, 1992 edition.

**Item Number: 5.434.10**

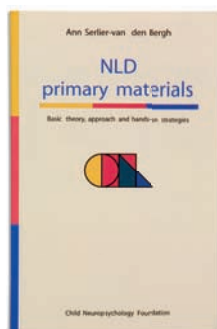

### **NLD: Primary Materials**

Ann Serlier van den Bergh. Gives a practical overview of the basic theory, method and hands-on strategies of the materials for the intervention of children with the Nonverbal Learning Disabilities (NLD). Includes detailed descriptions of the disability, instructions, procedures and lesson plans for material use.

- 137 pp, soft cover, 2006 edition.

**Item Number: 5.203.00**

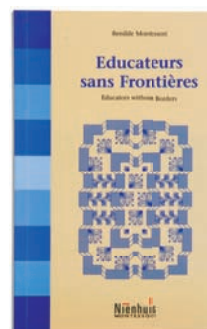

### **Educateurs sans Frontières**

Renilde Montessori. In this book, Renilde offers her own personal collection of snippets on child education. She conveys a series of underlying messages which provide an insightful theoretical basis for the concept of Educateurs sans Frontières.

- 76 pp, soft cover, 2005 edition.

**Item Number: 5.201.00**



### **Manual For An Integrated Approach To Mathematics**

Kaul. Through intensive work with the Montessori Mathematic Materials, a profound insight in basic arithmetic, algebra and geometric structures is acquired. This manual is an integrated approach to the world of mathematics.

- 242 pp, binder, 2010 edition.

**Item Number: 5.191.01**



### **Manual On Cosmic Education: An Integrated Approach To A Responsible Attitude Towards People And Nature**

Kaul. "Cosmic Education" takes into account the strong interest in the World and Life, especially for children between 6 and 12 years old. In Cosmic Education, the entire scientific system should be offered to the children. This manual is an integrated approach to a responsible attitude towards people and nature.

- 207 pp, binder, 2008 edition.

**Item Number: 5.192.01**

## For The Teacher



### Montessori Matters

Sisters of Notre Dame De Namur. A teacher's manual with illustrated lesson plans of basic Montessori exercises.

- 179 pp, soft cover, 1999 rev. edition.

**Item Number: 5.388.00**



### Montessori Matters: A History Manual

Sister Mary Motz. A guide to a didactic approach to giving the child historical appreciation and perspective.

- 79 pp, soft cover, 1997 edition.

**Item Number: 5.431.50**

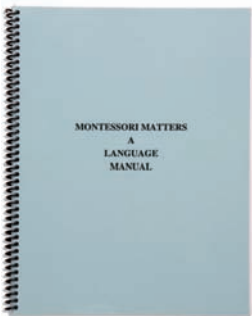

### Montessori Matters: A Language Manual

Sister Mary Motz. A practicum for the teaching of language skills, ages 3-9.

- 139 pp, soft cover, 1997 edition.

**Item Number: 5.431.00**

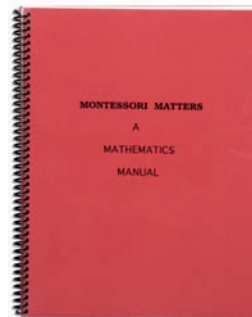

### Montessori Matters: A Mathematics Manual

Sister Mary Motz, S.N.D de N. Using the Montessori mathematics materials, this book details presentations and variations for numeration one to ten, numbers beyond ten and addition, subtraction, multiplication and division operations. Many memorization games and exercises are included.

- 58 pp, soft cover, 2001 edition.

**Item Number: 5.431.60**

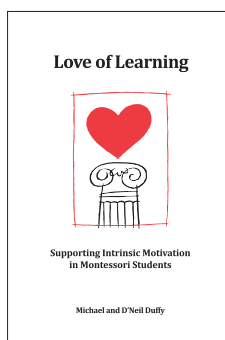

### Love Of Learning: Supporting Intrinsic Motivation In Montessori Students

Michael and D'Neal Duffy. The Duffys tackle the difficult challenge of encouraging the maintenance of students' intrinsic motivation. Explains the philosophical principles and theories and offers practical strategies for promoting motivation from within the student.

144 pp, soft cover, 2012 edition.

**Item Number: 5.429.00**





**Montessori Language Program**

A.M. Joosten, R.K. Gupta, A.W. Khandekar, D. A. Akbar. Montessori language program for children 3 to 6 years of age.

- 121 pp, soft cover, 1985 edition.

**Item Number: 5.365.10**



**The Practical Implementation Of Montessori Principles**

Dr. Maria Montessori, Albert M. Joosten, S.R. Swamy, Ram P. Bashyal, Rajendra K. Gupta. Articles by the authors include the environment, receiving new children, questions and answers, pupil learning, history, etc.

- 83 pp, soft cover, 2003 edition.

**Item Number: 5.363.00**

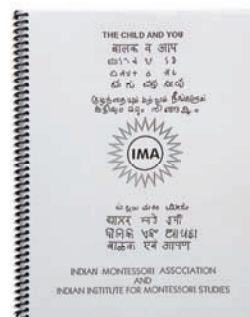

**The Child And You**

Gupta, Prakash, Rama K., Tandon. Notes and essays on many Montessori subjects. From the India Montessori Association and the Indian Institute for Montessori Studies.

- 117 pp, soft cover, 1998 edition.

**Item Number: 5.366.00**



**The Child's Right To Develop**

Albert Joosten. Many of his observations and recollections including "On Becoming Who We Are".

- 47 pp, soft cover, 1995 edition.

**Item Number: 5.365.45**



**The Exercises Of Practical Life**

Albert Joosten. An overview of practical life in the Montessori classroom.

- 26 pp, soft cover, 1990 edition.

**Item Number: 5.365.40**

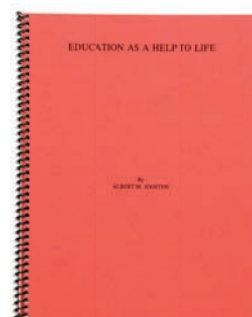

**Education As A Help To Life**

Albert Joosten. This book presents an overview of Dr. Maria Montessori and the philosophy of the Montessori method.

- 81 pp, soft cover, 1995 edition.

**Item Number: 5.365.50**

## Art

### Child-Size Masterpieces

A series of books made of card stock, presenting reproductions of the works of famous artists. The reproductions are to be cut-out from the book. Starting with matching exercises, the series progresses to labeling and grouping exercises. Backs of cards provide additional information on each painting and the artist.

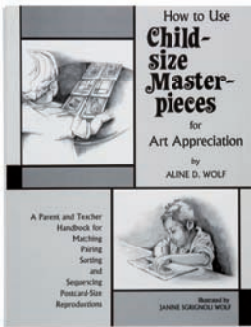

#### How To Use Child-Size Masterpieces

Aline D. Wolf, illustrated by Janine S. Wolf. Detailed instructions on how to prepare and use the art cards with young children. Use with Child-Sized Masterpieces series of books.

- 68 pp, soft cover, 2010 edition.

Item Number: 5.381.00



#### Child-Size Masterpieces: Easy (1)

- 39 cards, 1986 edition.

Item Number: 5.381.50



#### Child-Size Masterpieces: Artists Names (4)

- 36 cards, 1989 edition.

Item Number: 5.381.90

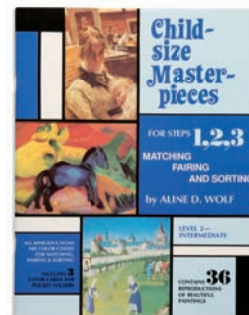

#### Child-Size Masterpieces: Intermediate (2)

- 39 cards, 1987 edition.

Item Number: 5.381.60



#### Child-Size Masterpieces: Advanced (3)

- 39 cards, 1987 edition.

Item Number: 5.381.70

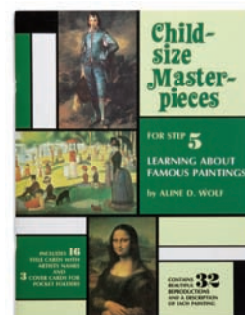

#### Child-Size Masterpieces: Famous Paintings (5)

- 35 cards, 1990 edition.

Item Number: 5.381.80



**Child-Size Masterpieces: Black Images**

- 40 cards, 1991 edition.
- Item Number: 5.381.91**



**Child-Sized Masterpieces: Modern Schools Of Art**

- 40 cards, 2006 edition.
- Item Number: 5.381.93**



**Child-Size Masterpieces: Transportation In America**

- 49 cards, 1992 edition.
- Item Number: 5.381.92**

**For Teaching Foreign Language**



**Touch Spanish: 2**

Gabriela Wilcox. Introduces phonics in the Spanish language, necessary for beginning reading.

- 164 pp, binder, 8th edition, 2011.
- Item Number: 5.422.00**



**Touch Spanish: 1**

Gabriela Wilcox. Instructions and cards for introducing Spanish to children. "Touch Spanish" develops oral and written communication. Includes picture cards, labels and control cards.

- 213 pp, binder, 26th edition, 2011.
- Item Number: 5.421.00**



**Touch Spanish: 3**

Gabriela Wilcox. Introduces verbs and pronouns in the Spanish language. It teaches the use of pronouns and verbs in the infinitive form with the help of a few conjugated verbs.

- 220 pp, binder, 5th edition, 2011.
- Item Number: 5.423.00**

## Music - Books & CD's

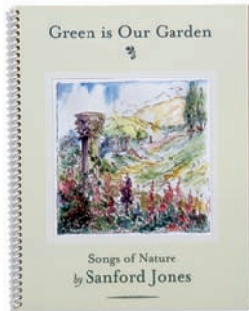

### Green Is Our Garden: Songs Of Nature

Sanford Jones. A collection of 24 music pieces.

- 55 pp, soft cover, 2006 edition.

**Item Number: 5.340.00**



### CD: Green Is Our Garden: Songs Of Nature

Sanford Jones. Accompanies the "Green Is Our Garden" music book.

**Item Number: 5.341.00**



### Folk Songs From Around The World

Sanford Jones. A collection of 17 music pieces.

- 19 pp, soft cover, 1980 edition.

**Item Number: 5.344.00**

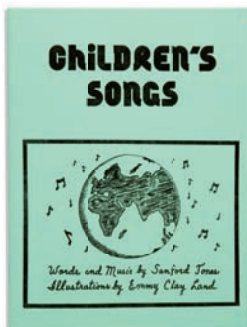

### Children's And Folk Songs

Sanford Jones. A collection of 23 music pieces.

- 23 pp, soft cover, 1987 edition.

**Item Number: 5.342.00**



### CD: Children's And Folk Songs

Sanford Jones. Accompanies the "Children's And Folk Songs" Music book.

**Item Number: 5.343.00**



**Montessori Music - Sensorial Exploration And Notation With The Bells**

Jean K. Miller, Ph.D. Illustrated handbook with detailed instructions for sensorial presentations and notation introduction. For use with 5.682.00 and 0.063.A0.

- 26 pp, heavy stock, 2008 edition.

**Item Number: 5.350.00**



**Music And Movement Instructional DVD For Montessori Teachers**

Sanford and Judy Jones, Youth Opera International, Inc. This DVD shows teachers how to structure Movement Exercises, Music Appreciation Activities, Singing Lessons, The Montessori Bell Lessons and Sensorial Through Notation. The DVD is geared toward children ages 3, 4 and 5 and is divided into 3 lessons – Jumping, Even and Uneven Rhythms and a Small Group Lesson on the Montessori Bells.

**Item Number: 5.349.00**

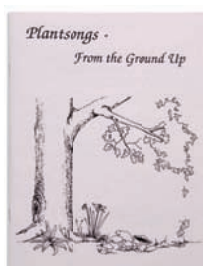

**Plantsongs - From The Ground Up**

Bruce Marbin. Five songs with staff notes, words and illustrations. Titles are: The Tree, The Flower, Leaves, Roots and Mushrooms.

- 5 pp, soft cover, 1989 edition.

**Item Number: 5.370.00**



**Montessori Mozarts**

Maureen Harris. A music curriculum. Gives the necessary skills to provide musical experiences to the children in a knowledgeable manner. Includes lesson plans and 2 CD's.

- 106 pp, soft cover, 2005 edition.

**Item Number: 5.352.00**

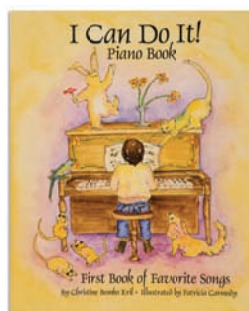

**I Can Do It! - Piano Book**

Christine Bemko Kril. Written for children and adults who wish to learn to play the piano or keyboard. A step-by-step approach to learning music in a fun, encouraging manner. Includes a color keyboard finger chart and songs.

- 79 pp, soft cover, 2005 edition.

**Item Number: 5.351.00**

## Science

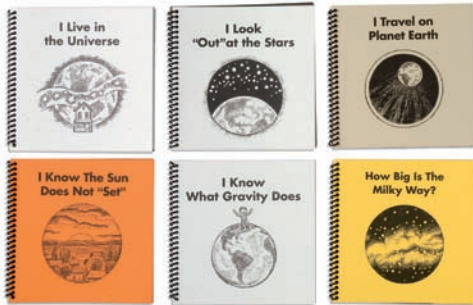

### The Cosmic Wonder Books

Aline D. Wolf. Introduces the universe and planet earth. Set of 6 books.

- 24 pp each, soft cover, 2000 edition.

**Item Number: 5.416.00**



### Thoughtful Living Series

Aline D. Wolf. Introduces nature and peace. Set of 6 books.

- 24 pp each, soft cover, 2000 edition.

**Item Number: 5.417.00**

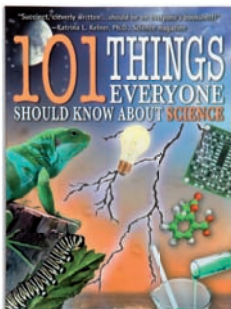

### 101 Things Everyone Should Know About Science

Dia L. Michels. Nathan Levy. An impressive source of science information for all ages. Written in a question-and-answer format filled with fun facts and concise explanations.

- 160 pp, soft cover, 2006 edition.

**Item Number: 5.369.00**

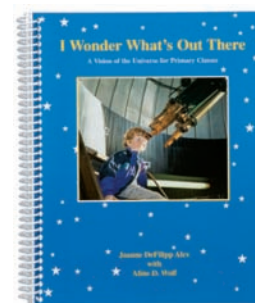

### I Wonder What's Out There

Joanne DeFilipp Alex with Aline D. Wolf. A vision of the universe for primary classes. This book progresses from day and night skies, stars, the solar system to living in space and becoming stewards of the earth.

- 64 pp, soft cover, spiral bound, 2003 edition.

**Item Number: 5.419.00**

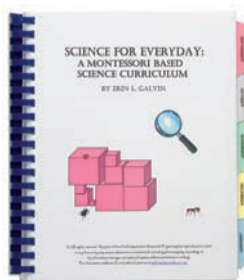

### Science For Everyday: A Montessori Based Science Curriculum

E.L. Galvin. Provides an extensive science curriculum for the Montessori early childhood classroom. Includes comprehensive introduction with integration and assessment details. 70 science lesson activities are presented with monthly scheduling suggestions.

- 156 pp, soft cover, 2001 edition.

**Item Number: 5.313.00**



### A New Approach To Zoology Nomenclature

R. Gupta. Based on the Montessori approach, presents a complete zoology nomenclature.

- 68 pp, soft cover, 1995 edition.

**Item Number: 5.365.20**



### Researching Montessori Zoology Program

R. Gupta. Research based on Dr. Maria Montessori's work and the author's ideas for modification and improvements.

- 96 pp, soft cover, 1987 edition.

**Item Number: 5.365.00**



### Botany As A Means Of Development

R. Gupta. A comprehensive description of the presentation of botany based on the refresher course given by the late Albert Joosten in India during 1957-1958.

- 82 pp, soft cover, 1995 edition.

**Item Number: 5.365.05**



### Science Experiences: Part 1

R. Gupta. A collection of easily performed experiments.

- 50 pp, soft cover, 1995 edition.

**Item Number: 5.365.30**

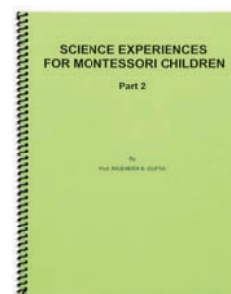

### Science Experiences: Part 2

R. Gupta. A collection of easily performed experiments.

- 56 pp, soft cover, 1995 edition.

**Item Number: 5.365.31**

## Science

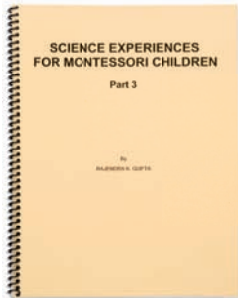

### Science Experiences: Part 3

R. Gupta. A collection of easily performed experiments.

- 38 pp, soft cover, 1995 edition.

**Item Number: 5.365.32**

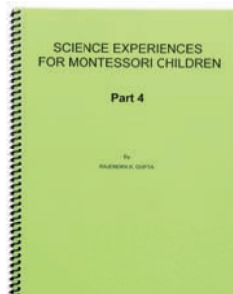

### Science Experiences: Part 4

R. Gupta. A collection of easily performed experiments.

- 51 pp, soft cover, 1995 edition.

**Item Number: 5.365.33**

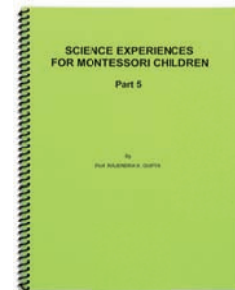

### Science Experiences: Part 5

R. Gupta. A collection of easily performed experiments.

- 51 pp, soft cover, 1995 edition.

**Item Number: 5.365.34**



### Science Experiences: Part 6

R. Gupta. A collection of easily performed experiments.

- 60 pp, soft cover, 1998 edition.

**Item Number: 5.365.35**

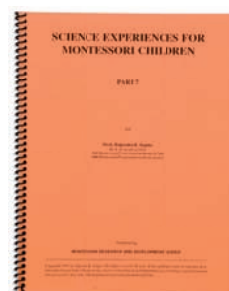

### Science Experiences: Part 7

R. Gupta. A collection of easily performed experiments.

- 38 pp, soft cover, 1998 edition.

**Item Number: 5.365.36**



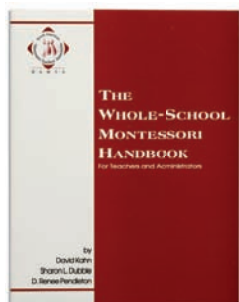

**The Whole School Montessori Handbook**

D. Kahn, S. Dubble & D. R. Pendleton. Topics include starting a school, organization, funding, finance, materials, policies, procedures, and more.

- 700 pp, soft cover, 1999 edition, NAMTA.

**Item Number: 5.355.00**



**The Whole School Montessori Handbook: Supplement**

D. Kahn. This supplement to the 1999 Whole-School Montessori Handbook looks at new developments in the issues schools encounter every day. Based on real documentation from Montessori schools throughout the U.S. and Canada, this book offers nuts-and-bolts advice and model practices.

- 346 pp, soft cover, 2007 edition, NAMTA.

**Item Number: 5.354.00**



**DVD: At Home In Nature: Biology In The Montessori Classroom**

Sanford Jones, Youth Opera International, Inc. This video provides a hands-on approach on how to set up the classroom for the study of biology. Includes: use of the Botany Cabinet, how to select pets for the classroom, how to select and repot plants, building an outdoor garden, preparing healthy foods at school, methods of recycling, composting at school, and much more. This DVD is a valuable asset to a school's resource library.

**Item Number: 5.348.00**

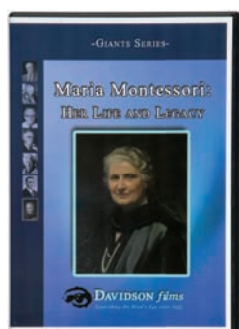

**DVD: "Maria Montessori" Her Life And Legacy**

With Annette Haines, Ed. D. This film introduces the basic tenets and methodology of Montessori education with film sequences from 3 schools showing children independently learning in their carefully prepared environment. Includes a sequence on Dr. Montessori's life portrayed through rare archival photos.

- 35 minutes, 2004 edition.

**Item Number: 5.685.00**

## Reference & DVD's



### **Camillo Grazzini: Celebrating Fifty Years Of Montessori Service**

Vol. 29, number 1, special edition, David Kahn.

- NAMTA JOURNAL: 295 pp, soft cover, 2004 edition

**Item Number: 5.362.00**



### **DVD: Montessori In Action**

The narrative explains the fundamental principles of the Montessori approach to early education. The video is essential viewing for any parent contemplating a Montessori education for their child. It also serves as an introduction to Montessori education for those who wish to deepen their knowledge in this fascinating area of educational philosophy.

- Narrated by Lynne Lawrence

**Item Number: 9.756.00**

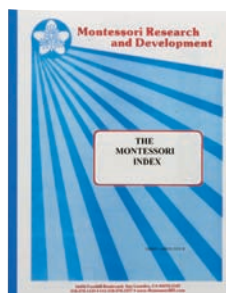

### **The Montessori Index**

Virginia B. Fleege. An index of subjects from the books of Maria Montessori and other authors.

- 155 pp, soft cover, 1987 edition.

**Item Number: 5.379.50**

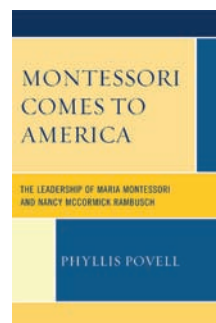

### **Montessori Comes to America**

Phyllis Powell. In Montessori Comes To America, Powell traces the evolution of women's leadership and its influence on the Montessori Methods development.

- 154 pp, soft cover, 2010 edition.

**Item Number: 5.459.00**

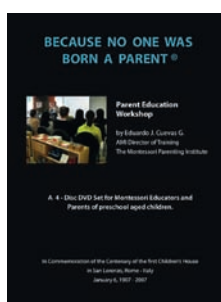

### **DVD: Because No One Was Born A Parent...**

Eduardo Cuevas. The 'Because No One Was Born A Parent'® DVD series introduces parents and educators to the fundamentals of child development from a Montessori perspective.

The 4-disc set is a professional development tool for educators and administrators- includes the Workshop, plus an additional disc that introduces the concept of a Parent Study Program and a step-by-step model for setting one up.

- 4 Disc Set

**Item Number: 5.686.00**



# Arts And Crafts

Children love to work with Arts and Crafts. It is a wonderful form of expression; it inspires their creativity and stimulates their minds. They create things they love, and have fun while doing it.

In addition, working with art is known to have many developmental benefits for the child. They extend their creative thinking abilities, they learn to express their feelings with or without words, and they practice their problem-solving and critical-thinking skills.

In this chapter you will find everything you need to enhance the art area in your classroom. We have finger and poster paint – in a wide variety of vibrant colors of the finest quality. All are non-toxic and washable. Easels, drying racks, paper, paint brushes, paint pots, glue, paste, crayons, markers, chalk and much more. All you will need to stimulate the child's creativity.

Art introduces children to cultures from around the world. Art builds confidence. Art builds community. Art is essential for every child.

**Finger-Paint: 1 Liter**

9 vibrant colors delivered in a handy squeeze bottle.  
The paint is non-toxic and has an ideal consistency for spreading.

**Item Number: 030.001 - White**

**Item Number: 030.002 - Yellow**

**Item Number: 030.003 - Red**

**Item Number: 030.004 - Violet**

**Item Number: 030.005 - Blue**

**Item Number: 030.006 - Green**

**Item Number: 030.007 - Brown**

**Item Number: 030.008 - Black**

**Item Number: 030.009 - Orange**



## For Painting

### Poster Paint: 1 Liter

Economical, ready-to-use poster paint, in large, handy, squeeze bottles. The paint flows thickly and dries quickly. Matt finish, covers well. Interpaint can be used on almost any absorbent surface. There are 23 striking colors and 1 varnish.

Item Number: 062.030 - Gold

Item Number: 062.031 - Silver

Item Number: 062.032 - Glitter-Silver

Item Number: 062.033 - Bronze

Item Number: 062.601 - White

Item Number: 062.603 - Yellow

Item Number: 062.605 - Yellow Gold

Item Number: 062.610 - Orange

Item Number: 062.611 - Light Red

Item Number: 062.612 - Dark Red

Item Number: 062.615 - Light Green

Item Number: 062.616 - Dark Green

Item Number: 062.620 - Light Blue

Item Number: 062.621 - Dark Blue

Item Number: 062.627 - Brown

Item Number: 062.628 - Light Brown

Item Number: 062.629 - Chocolate Brown

Item Number: 062.645 - Black

Item Number: 062.650 - Violet

Item Number: 062.651 - Pink

Item Number: 062.652 - Light Pink

Item Number: 062.653 - Lemon Yellow

Item Number: 062.654 - Peach

Item Number: 062.670 - Varnish



**Lyons Paint Brushes: Long Handle – Flat Bristles**

Wooden handle with natural finish, fitted with a seamless aluminum ferrule. The length of the handle varies from 28 to 35 cm, depending on the size. Sold in boxes of 12.

- Item Number: 040.113 – Paint Brush No. 6: Flat Bristles (12)**
- Item Number: 040.115 – Paint Brush No. 10: Flat Bristles (12)**
- Item Number: 040.117 – Paint Brush No. 14: Flat Bristles (12)**
- Item Number: 040.119 – Paint Brush No. 18: Flat Bristles (12)**
- Item Number: 040.121 – Paint Brush No. 22: Flat Bristles (12)**



**Lyons Paint Brushes: Long Handle – Round Bristles**

Wooden handle with natural finish, fitted with a seamless aluminum ferrule. The length of the handle varies from 28 to 35 cm, depending on the size. Sold in boxes of 12.

- Item Number: 040.170 – Paint Brush No. 4: Round Bristles (12)**
- Item Number: 040.171 – Paint Brush No. 6: Round Bristles (12)**
- Item Number: 040.173 – Paint Brush No. 10: Round Bristles (12)**
- Item Number: 040.175 – Paint Brush No. 14: Round Bristles (12)**
- Item Number: 040.177 – Paint Brush No. 18: Round Bristles (12)**



**Watercolor Paint Brushes: Tapered Bristles**

Wooden handle with red enamel finish, fitted with a seamless aluminum ferrule. The length of the handle varies from 17 to 21 cm, depending on the size. Sold in boxes of 12.

- Item Number: 040.071 – Watercolor Paint Brush No. 2: (12)**
- Item Number: 040.074 – Watercolor Paint Brush No. 5: (12)**
- Item Number: 040.077 – Watercolor Paint Brush No. 8: (12)**
- Item Number: 040.079 – Watercolor Paint Brush No. 10: (12)**



## For Painting

### Dabbing/Spatter Painting Paint Brushes

Wooden handle with natural finish, fitted with an aluminum ferrule. The girth of the round bristle varies from 6 to 18 mm, depending on the size. Sold in boxes of 12.

- Item Number: 077.036 – Dabbing/Spatter Painting Brush No. 4: (12)**
- Item Number: 077.037 – Dabbing/Spatter Painting Brush No. 8: (12)**
- Item Number: 077.038 – Dabbing/Spatter Painting Brush No. 10: (12)**
- Item Number: 077.039 – Dabbing/Spatter Painting Brush No. 16: (12)**



### Toddler Paint Brush: Per 12

Specially made for small hands. Brush is 17 cm in length and has a colorful red wooden handle. Sold in boxes of 12.

**Item Number: 040.100**

### Non-Spill Paint Cups

Made of unbreakable plastic with an airtight lid, which prevents the paint from spilling or drying out. Available in 2 sizes – 125 ml and 320 ml. Paint cups fit inside the Trays (see 512.060 and 512.061).

- Item Number: 512.268 – Paint Cup With Lid (125 ml): 1**
- Item Number: 512.058 – Paint Cup With Lid (320 ml): 1**



### Paint Cup Trays

Plastic trays designed for use with the Paint Cups. Holds 6 cups side by side. Available in two sizes – one for holding the 125 ml size paint cups; the other for holding the 320 ml size paint cups. (Paint Cups sold separately).

- Item Number: 512.060 – Paint Cup Tray - 125 ml: Holds 6 Cups**
- Item Number: 512.061 – Paint Cup Tray - 320 ml: Holds 6 Cups**







**Round Paint Cups With Lid: Set Of 3**

Cups are round with a flat bottom for stability. Set includes 3 different size cups, each with a lid: 44 mm, 50 mm and 57 mm.

**Item Number: 040.098**

**Finger-Paint Pots: Set Of 10**

Unbreakable plastic finger-paint pots, each with an airtight lid that prevents the finger-paint from spilling or drying out. Pots are stackable for easy storage. Set of 10 individual pots.

**Item Number: 522.790**



**Paint Palette**

A plastic palette divided into 6 sections for use with tempera, watercolor or poster paint. Sections are 55 mm in diameter.

**Item Number: 040.134**

## For Painting



### Two-Piece Paint Palette Tray

Item is two-pieces – a 4-section palette and a bottom tray. The bottom tray holds the 4-section palette like a bucket to prevent paint from spilling over and has notches to hold the brushes.

**Item Number: 522.097**



### Spatter Paint Screen

Red plastic frames the screen and has a handle for ease of use. For spatter and other painting. Screen size 9 x 14 cm.

**Item Number: 047.001**

### Paper For Painting

Available in 3 different sizes – 25 x 32.5 cm, 32.5 x 50 cm and 50 x 65 cm. Paper weight: 90 grams. Sold in packs of 500 sheets.

**Item Number: 092.014 – Paper For Painting – 25 x 32.5 cm: (500)**

**Item Number: 092.012 – Paper For Painting – 32.5 x 50 cm: (500)**

**Item Number: 092.011 – Paper For Painting – 50 x 65 cm: (500)**





**Post-It Drawing Paper: 30.5 x 23 cm**  
Item Number: 125.010

### **Drying Racks**

Metal racks for drying children's paintings or other art projects. Two sizes to choose from – one has 25 shelves (46 x 34 x 97 cm); the other 30 shelves (71 x 50 x 112 cm). Both are provided with rubber castors.

**Item Number: 523.019 – Drying Rack: 25 Shelves**

**Item Number: 523.033 – Drying Rack: 30 Shelves**



## For Painting

### Airer: Paint/Clothes Drying Stand

Wooden stand for drying children's paintings or other art projects. Legs fold for easy storage. 45 x 35 x 56 cm.

**Item Number: 522.478**



### Clothes Pins: (24)

Contains a bag of 24 clothes pins.

**Item Number: 036.220**

**Easel: 2 Boards**

The 2 Board Easel is sturdy and adjustable in height. The design allows 2 children to work simultaneously - 1 on each side. The paper is attached using clamps, tape or other means (not included). For canvas use, we suggest resting the canvas on the tray. 55 x 142 x 59 cm.

**Item Number: 1.877.00**



## For Painting

### Easel: 4 Boards

The 4 Board Easel is sturdy and is adjustable in height. The design allows 4 children to work simultaneously - 2 on each side. The paper is attached using clamps, tape or other means (not included). For canvas use, we suggest resting the canvas on the tray. 105 x 142 x 59 cm.

**Item Number: 1.876.00**





**Crayons: 12 Colors**

Wax crayons in 12 brilliant colors. Crayons are 116 mm long and 14 mm in diameter.

**Item Number: 010.001**

**Heutink Gigantjes Markers: 10 Colors**

The thick outside diameter of these markers are great for small hands. Easily washed from most fabrics. 10 assorted colors in a plastic wallet.

**Item Number: 080.024**



**Heutink Basic Markers: Fine Point - 10 Colors**

These excellent markers have a hard tip for drawing fine lines. Easily washed from most fabrics. 10 assorted colors in a plastic wallet.

**Item Number: 080.058**



**Heutink Basic Markers: Medium Point – 10 Colors**

These excellent markers have a medium point and are easily washed from most fabrics. 10 assorted colors in a plastic wallet.

**Item Number: 080.023**



## For Drawing

### Anti-Dust Chalk: White

Designed to prevent chalk residue when writing, and dust clouds when cleaning. Sold in boxes of 12.

**Item Number: 035.006**



### Anti-Dust Chalk: Colored

Designed to prevent chalk residue when writing, and dust clouds when cleaning. Sold in boxes of 12. Six colors – 2 each of: yellow, orange, green, blue, purple and pink.

**Item Number: 035.016**

### Small Blackboard Eraser

**Item Number: 7.405.00**



### Heutink Goldline: Lead Pencils (12)

Lead pencils with medium lead hardness. Sold in boxes of 12.

**Item Number: 061.065**



### 3-Sided Lead Pencils: (72)

Lead pencils that match our 3-Sided Inset pencils. The 3-Sided pencil is more comfortable in the hand and aids in teaching the children the correct way to hold a pencil. Sold in a box of 72.

**Item Number: 061.240**





### 3-Sided Inset Pencils

Our 3-sided inset pencils come in a wide variety of colors that match perfectly with the Montessori materials. We chose 3-sided as it is more comfortable in the hand, and aids in teaching children the correct way to hold a pencil. 18 colors, sold in single boxes of 12.



**3-Sided Inset Pencils: Red**  
Item Number: 7.202.00



**3-Sided Inset Pencils: Gold**  
Item Number: 7.206.00



**3-Sided Inset Pencils: Dark Blue**  
Item Number: 7.203.00



**3-Sided Inset Pencils: Yellow**  
Item Number: 7.207.00



**3-Sided Inset Pencils: Green**  
Item Number: 7.204.00



**3-Sided Inset Pencils: Orange**  
Item Number: 7.208.00



**3-Sided Inset Pencils: Violet**  
Item Number: 7.205.00



**3-Sided Inset Pencils: Light Blue**  
Item Number: 7.209.00

## For Drawing



**3-Sided Inset Pencils: Light Green**  
Item Number: 7.210.00



**3-Sided Inset Pencils: White**  
Item Number: 7.214.00



**3-Sided Inset Pencils: Black**  
Item Number: 7.211.00



**3-Sided Inset Pencils: Dark Green**  
Item Number: 7.215.00



**3-Sided Inset Pencils: Gray**  
Item Number: 7.211.50



**3-Sided Inset Pencils: Light Yellow**  
Item Number: 7.216.00



**3-Sided Inset Pencils: Pink**  
Item Number: 7.212.00



**3-Sided Inset Pencils: Light Brown**  
Item Number: 7.217.00



**3-Sided Inset Pencils: Brown**  
Item Number: 7.213.00



**3-Sided Inset Pencils: Peach**  
Item Number: 7.218.00



**Colored Inset Pencil Holders: Set Of 11**  
Item Number: 7.305.00

**Natural Wood Pencil Holder**  
Item Number: 7.317.00



**Pencil Sharpener: For 3-Sided Pencils - Small**  
Item Number: 025.214



**Pencil Sharpener: For All Pencil Types - Table Model**  
Item Number: 035.055

**Pencil Sharpener: For All Pencil Types - Electric**  
Item Number: 035.063



## For Crafting

### Craft Paper: Round

Our round craft paper is available in 2 different sizes: 12 cm round and 16 cm round. 12 assorted colors. Sold in packs of 480 sheets.

**Item Number: 084.017 – Craft Paper Round - 12 cm: (480)**

**Item Number: 084.018 – Craft Paper Round - 16 cm: (480)**



### Craft Paper Boxes

Varnished beech wood boxes specially designed for our square craft papers. 4 different sizes: 10 x 10 cm, 12 x 12 cm, 16 x 16 cm, and 20 x 20 cm. (paper not included).

**Item Number: 009.140 – Craft Paper Box: 10 x 10 cm**

**Item Number: 009.141 – Craft Paper Box: 12 x 12 cm**

**Item Number: 009.142 – Craft Paper Box: 16 x 16 cm**

**Item Number: 009.143 – Craft Paper Box: 20 x 20 cm**



### Craft Paper: Square

Our square craft paper is available in 5 different sizes: 8 x 8 cm, 10 x 10 cm, 12 x 12 cm, 16 x 16 cm, and 20 x 20 cm. 12 assorted colors. Sold in packs of 480 sheets.

**Item Number: 084.034 – Craft Paper Square - 8 x 8 cm: (480)**

**Item Number: 084.035 – Craft Paper Square - 10 x 10 cm: (480)**

**Item Number: 084.036 – Craft Paper Square - 12 x 12 cm: (480)**

**Item Number: 084.037 – Craft Paper Square - 16 x 16 cm: (480)**

**Item Number: 084.038 – Craft Paper Square - 20 x 20 cm: (480)**





### **Stand For Paper Boxes**

An excellent Stand that saves precious shelf space. Specially designed to hold our Craft Paper Boxes. Boxes are easily attached to the front (paper boxes not included).

**Item Number: 522.675**

### **Crêpe Paper: 10 Colors**

Paper size: 50 x 250 cm with a 75% stretch. Set of 10 brilliant colors.

**Item Number: 083.115**



### **Sewing/Embroidery Paper – Assorted Colors: (100)**

An excellent paper used for the introduction of sewing and embroidery activities to the children. Develops hand-eye coordination and is a good preparation for writing. Paper size: 23.7 x 31.2 cm. Paper weight: 290 grams. 14 vibrant colors, sold in packs of 100 sheets.

**Item Number: 049.007**

## For Crafting

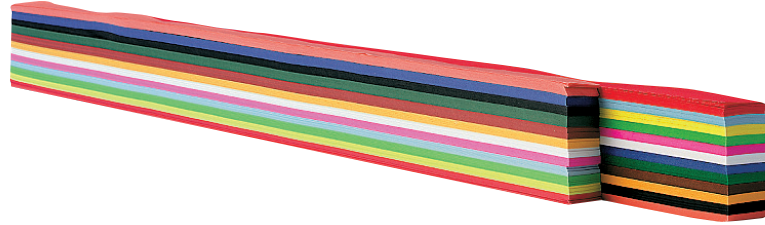

### Weaving Strips

Pack of 480 strips in 12 colors. 40 strips per pack.  
Colors are: cherry red, canary yellow, marine blue, sky blue, may green, violet, orange, fawn, pearl grey, black, cerise and dark green.

**Item Number: 084.006 - 50 x 1 cm (480)**

**Item Number: 084.007 - 50 x 1.5 cm (480)**

**Item Number: 084.008 - 50 x 2 cm (480)**

**Item Number: 084.010 - 50 x 4 cm (480)**

### Weaving Strips: Display

For storing the 4 sizes of weaving strips  
53 x 12.5 x 7 cm (weaving strips not included).

**Item Number: 522.620**





**Weaving Mats: White (100)**  
Item Number: 522.170

**Weaving Mats: Colored (50)**  
Item Number: 083.093



### Craft Mats

These craft mats are available in 2 sizes: 19 x 33 cm and 40 x 57 cm. Used for a wide array of art and craft projects. Protects tables and desks. Mat thickness: 3 mm.

**Item Number: 009.149 – Craft Mat: 19 x 33 cm**

**Item Number: 009.150 – Craft Mat: 40 x 57 cm**

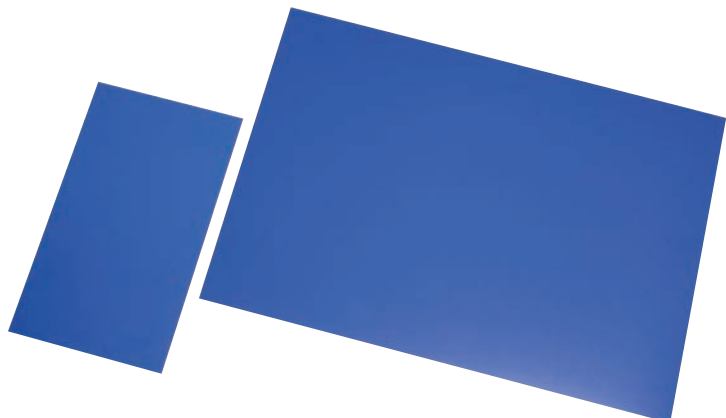

## For Crafting

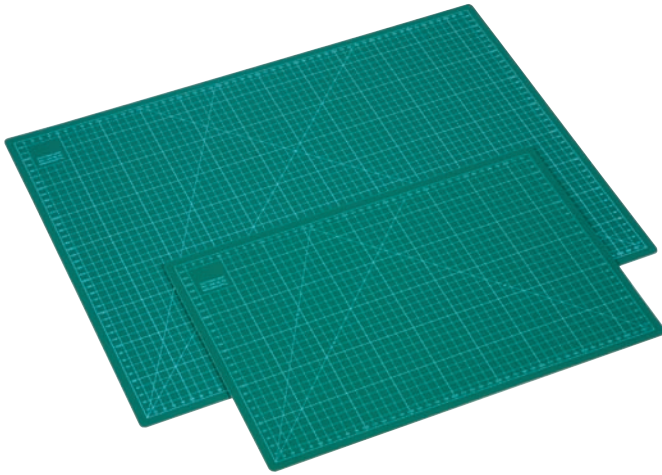

### Cutting Mats

These cutting mats are available in 2 sizes: 30 x 45 cm and 45 x 60 cm. Used for all types of cutting. Protects tables and desks. Mat thickness: 3 mm.

**Item Number: 021.530 – Cutting Mat: 30 x 45 cm**

**Item Number: 021.531 – Cutting Mat: 45 x 60 cm**

### Cutting And Scissor Tray

An all-inclusive set for cutting exercises in the classroom. Includes: a wooden tray and small box, a pair of scissors and several scissors exercise sheets. See 5.677.00 Scissors Exercises to order additional sheets.

**Item Number: 0.400.00**



**Blunt Scissors: 10 cm**

**Item Number: 7.701.00**



**Toddler Scissors: 9 cm**

**Item Number: 7.703.00**



**Sharp Scissors: 13 cm**

**Item Number: 076.002**



**Glue And Paste Box**

An all-inclusive set for gluing and pasting exercises in the classroom. Includes: a wooden box with six compartments, a glue/paste brush and a glass jar with lid. The lid of the box has a cutout hole that holds the jar upright to avoid spilling the contents.

**Item Number: 0.401.00**



**Glue/Paint/Paste Jar With Lid: (50 cc)**

A 50 cc glass jar with a screw top lid for storing glue, paint or paste.

**Item Number: 040.110**



**Paste Or Glue Brush (20 cm): Per 12**  
**Item Number: 040.094**



**Interglue: White Glue**

An outstanding glue with an excellent adhesive quality. Suitable for paper, cardboard, wood, felt, textiles, leather, etc. Dries completely transparent, is washable, easy to remove from the fingers and is non-toxic. Water-based. Environmentally friendly.

**Item Number: 016.001 – White Glue: (115 ml)**

**Item Number: 016.005 – White Glue: (1 Liter)**

## Glue And Paste



### Transparent Glue

A water-based, transparent, odorless, glue. Suitable for use on paper, cardboard, cork, wood, felt and various light plastics. An excellent glue for use with Toddlers. Washable in cold water. Environmentally friendly.

**Item Number: 081.095 – Transparent Glue: (115 ml)**

**Item Number: 081.096 – Transparent Glue: (1 Liter)**

### Plakplak: Powder Glue

A transparent cellulose adhesive in powder form. Perfect for gluing paper and working with paper maché. Mix with water. Solvent-free. One box makes approx. 25 liters of glue.

**Item Number: 030.044**



### Glutofix

A transparent cellulose adhesive in powder form. Perfect for gluing paper and working with paper maché. Mix with water. Solvent-free. One box makes approx. 25 liters of glue.

**Item Number: 030.043**

### Collall Glue/Paste: (150 ml)

Fantastic glue/paste sold in a plastic jar. Use with all types of paper. Solvent-free.

**Item Number: 082.010**





# Music

Music has been in our world from the time that only animals roamed the earth. It is thought that animals use a form of music to communicate – birds ‘sing’ songs we say, humpback whales ‘sing’ sonatas to communicate... It appears too that the first humans made music. They carved whistles out of animal bones and used them for communicating.

It is thought that when young children listen to music, that it helps them understand the beginnings of mathematics. In fact, it was Pythagoras that devised a mathematical formula for what is today’s musical scale.

The importance of music to children and humans in general is why we have expanded our assortment to include Music. We offer full sets of musical instruments, individual musical instruments, instruments of the world, and instruments that many of you may have never seen.

It is a wonderful assortment and we are sure you and your children will receive hours of pleasure playing and learning about them. Music is emotion, music is nostalgic, music is therapeutic and healing, and music is for every age.

**Music Instruments Set**  
Item Number: 522.160



**Cabinet For Music Materials**  
Item Number: 522.140







**Instruments Of The World: In Basket**

A set of 14 percussion instruments from Ghana, India and Indonesia supplied in a large basket.

**Item Number: 085.125**

**Rainmaker: 120 cm**  
**Item Number: 085.134**



**Rainmaker: 75 cm**  
**Item Number: 085.133**

**Rainmaker: 50 cm**  
**Item Number: 085.132**

### Djembe Drums

These hard crafted Djembe drums from West Africa are made out of one piece of wood.



Djembe Drum: 23 cm  
Item Number: 085.127



Djembe Drum: 36 cm  
Item Number: 085.128

### Recorder

Item Number: 085.044



### Maracas: (2)

Item Number: 085.031



## Trommels

Drums of varying sizes with complex tones.  
Made from natural skins.

**Trommel: 18 cm (28 cm diameter)**  
Item Number: 102.153



**Trommel: 31 cm (17 cm diameter)**  
Item Number: 102.154



## Hand Bells

Set of 8 high quality hand bells with pure tones.  
Item Number: 085.045

**Pipe Drum: 2 Tone**  
Item Number: 085.002





**Rhythm Sticks: (2)**  
Item Number: 085.024

**Cabasa**

Item Number: 085.040



**Hand Drum**

Item Number: 085.004

**Tuning Fork**

Item Number: 085.033

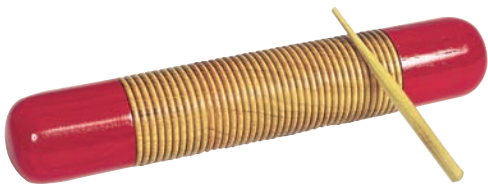

**Guiro**

Item Number: 085.041

**Metal Shaker Tube**

Item Number: 085.021

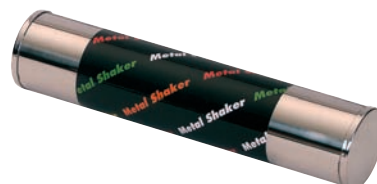



Toys for Life

# Enrichment

Young children learn through sensory perception. Quite often, grasping an object evolves into 'grasping' an idea. It is important for children to work with materials that not only are pleasing to the touch, but also enhance the learning experience in and of its self. The materials showcased on these pages support this theory in its entirety.

This chapter represents 3 of our Brands – Nienhuis, Toys for Life and Educo. The items that pertain to the specific brands are identified by the respective logos located at the bottom of each page. All are crafted of the finest materials, produced with the same care and responsibility as our Montessori materials, and have been developed in conjunction and consultation with educators and didactic specialists worldwide.

We have re-introduced past successes, included many old favorites, and added a slew of exciting new puzzles, games and manipulatives. There is even an outdoor play section to browse.

For Montessori classrooms... For after care programs... For children everywhere...





**The Animal Continent Box**

A first introduction to animal species from each of the 7 continents. Through working with The Animal Continent Box, children are inspired to work with the Puzzle Map Of The World Parts. Set includes: 28 high quality plastic animals, separate continent, picture, and label cards, 1 copy card and instructions, all housed in a nesting beechwood box.

**Item Number: 0.665.01**



**Animals Of The World**

A complimentary set to The Animal Continent Box. 4 species from each of the 7 continents are pictured and described. Set includes: a wooden box, 28 plastic animal description and picture cards, 7 continent tab cards and a spiral bound control booklet.

**Item Number: 0.666.01**



## The Roman Arch

This ingenious representation of a classic design allows the builder to discover the principle of the keystone and its function in the support of an arch. Made from beechwood.

**Item Number: 0.350.00**

### The Nail Board

Using The Nail Board, children learn different geometric shapes, angles, fractions and other patterns and how to create them using elastic bands. As they progress through the activity books, they explore more complex, advanced geometric concepts and relationships. Includes: a beechwood box with lid (lid serves as the nail board), elastic bands (red, green, blue and yellow) a mirror, a protractor (transparent plastic), four activity books and instructions.

**Item Number: 0.630.01**

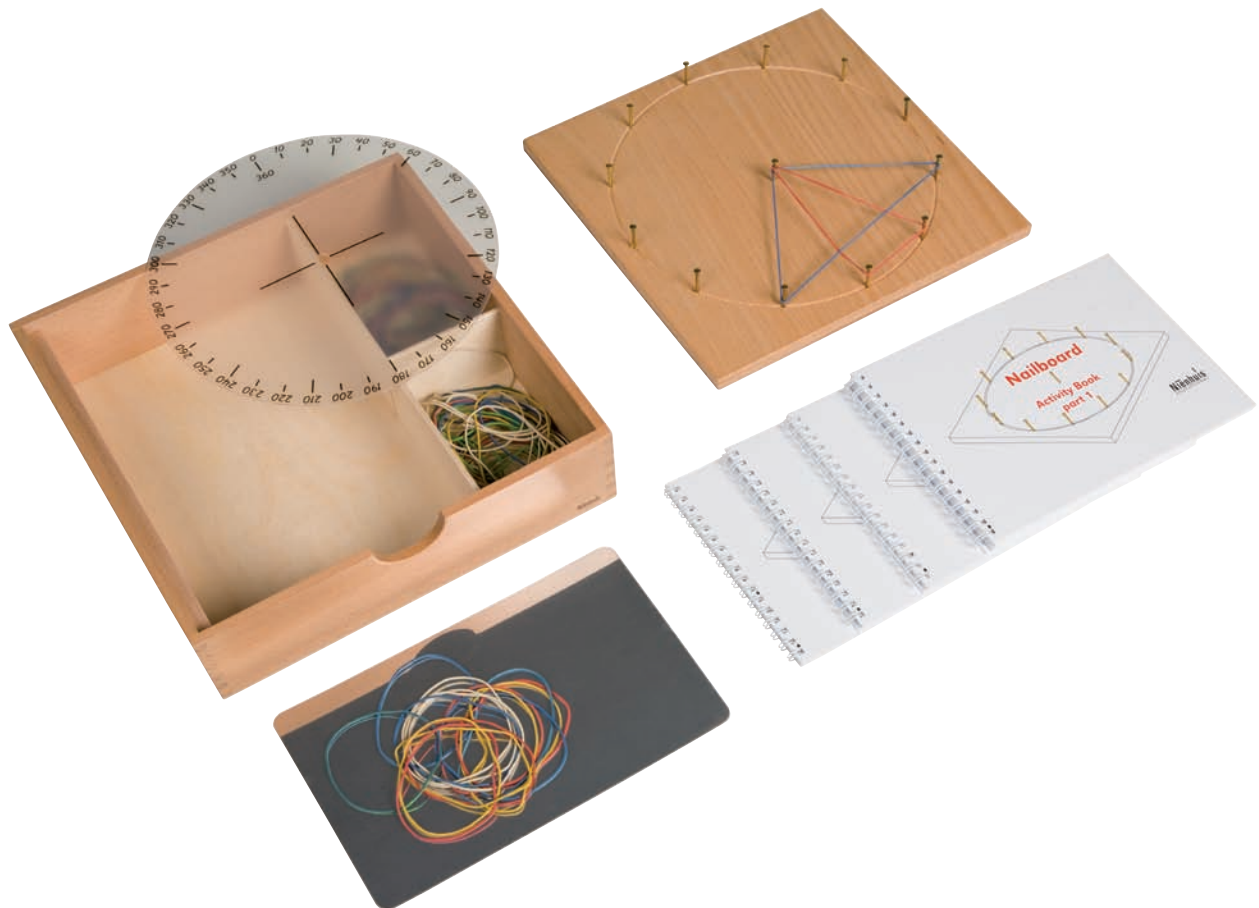

## The Stars Exercise

Using The Stars Exercise, children gain an understanding of the universe and become familiar with the star-spangled sky. The Stars Exercise includes the most significant stars and planets. This material is based on the Montessori concept of starting by showing the whole, in this case, the universe. Includes: a map showing the skies of the northern and southern hemispheres, a gold-colored box and a white box with yellow (northern hemisphere) and white (southern hemisphere) flags, a sheet of labels for the flags. On one side is the Latin name, on the other, the name of the constellations, 2 plastic printed circles showing the constellations, used as the control and instructions.

**Item Number: 0.850.00**



## Pin Flag Stand

Used to hold the pin flags while working with The Stars Exercise. Made of a self-healing material.

**Item Number: 0.174.00**



## Planets Of The Solar System

Contains 2 sets of full color nomenclature cards. 1 set with separate labels and 1 control set labeled at the bottom and a spiral bound book that contains a complete set for teaching and reference use. Cards are made of plastic for durability. Includes a wooden box for storage.

**Item Number: 0.770.01**





## Tellurium

Tellurium is a model used to demonstrate the movement of the earth and the moon around the sun. This attractive and captivating material is a simplified reproduction of the solar system. Tellurium is not a replica of the reality, but a model to explain the different principles of day and night, summer and winter and the positions of the moon. Tellurium visualizes to the children, the fascinating effects created by the rotational movements in our sun-earth-moon system.

### There are 3 major rotations:

- The earth rotates on its axis every day. The result is day and night, enabling us to see the sun, moon and stars moving across the sky.
- The moon revolves around the earth approximately every four weeks. The result is the different phases of the moon.
- The earth (with the moon) revolves around the sun in one year. This is where we get our seasons and the fact that we can see other constellations.

Using the flashlight, 'sunlight' can be projected on the earth and the moon to show the children the different effects as the earth and the moon revolve. Included is a figure that can be affixed on the globe to make it easier for the children to place themselves in the situation. An instruction manual that gives further information on the use of the Tellurium is included.

**Item Number: 0.851.01**



## Tellurium Activity Set

Additional exercises for use with Tellurium. Includes: exercises cards, divider tabs and a wooden box for storage.

**Item Number: 0.852.01**

## Time Lines

### The Black Ribbon

A black canvas cloth wrapped around a solid beechwood spool. Can be used for various activities in the classroom such as - creating time lines, evolution of man, periods in history, calendars, the solar system. By rolling out the black cloth and placing items on it, the children create a visual 'history' of the subject they are studying (animals not included, see 0.695.51). Length of Black Ribbon: 46 meters.

**Item Number: 0.695.00**

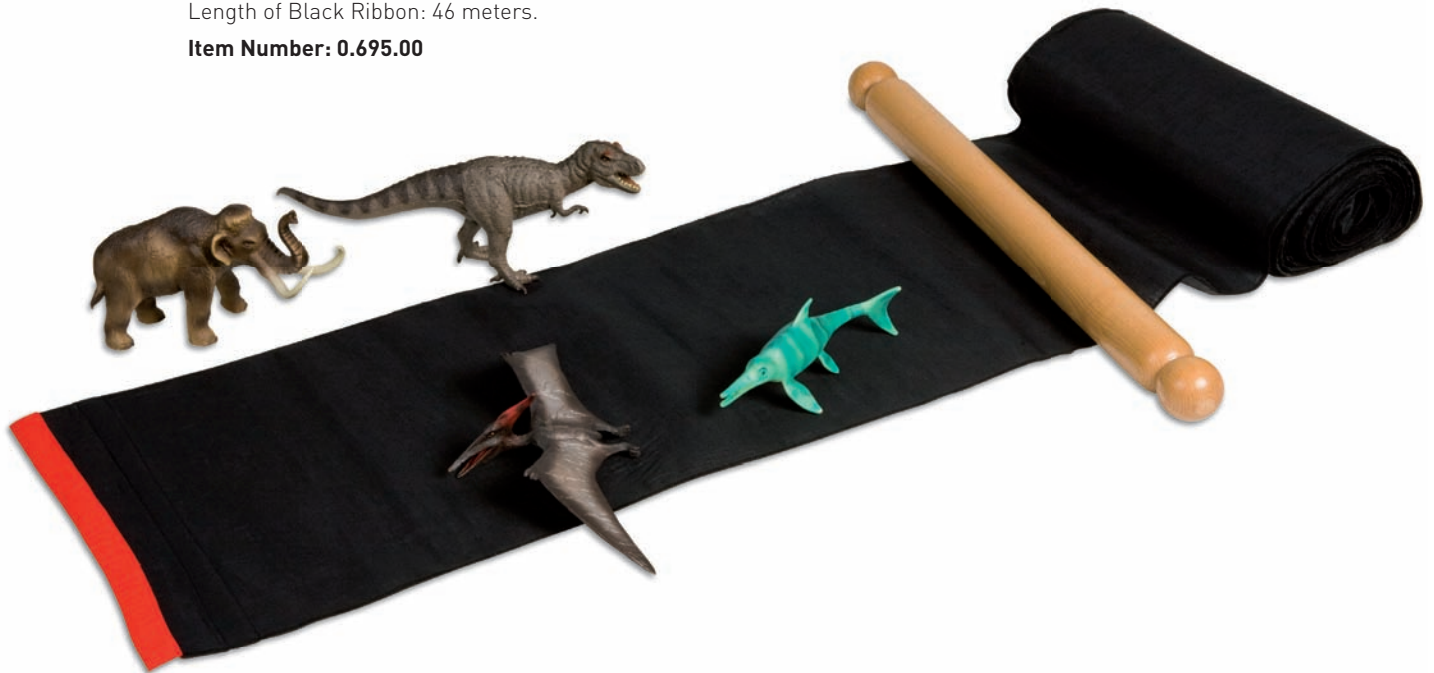

### Animals And Book For The Black Ribbon

Material includes: a set of large, high-quality plastic animals and a book with descriptions of each animal. This item is designed for use with The Black Ribbon (0.695.00).

**Item Number: 0.695.51**



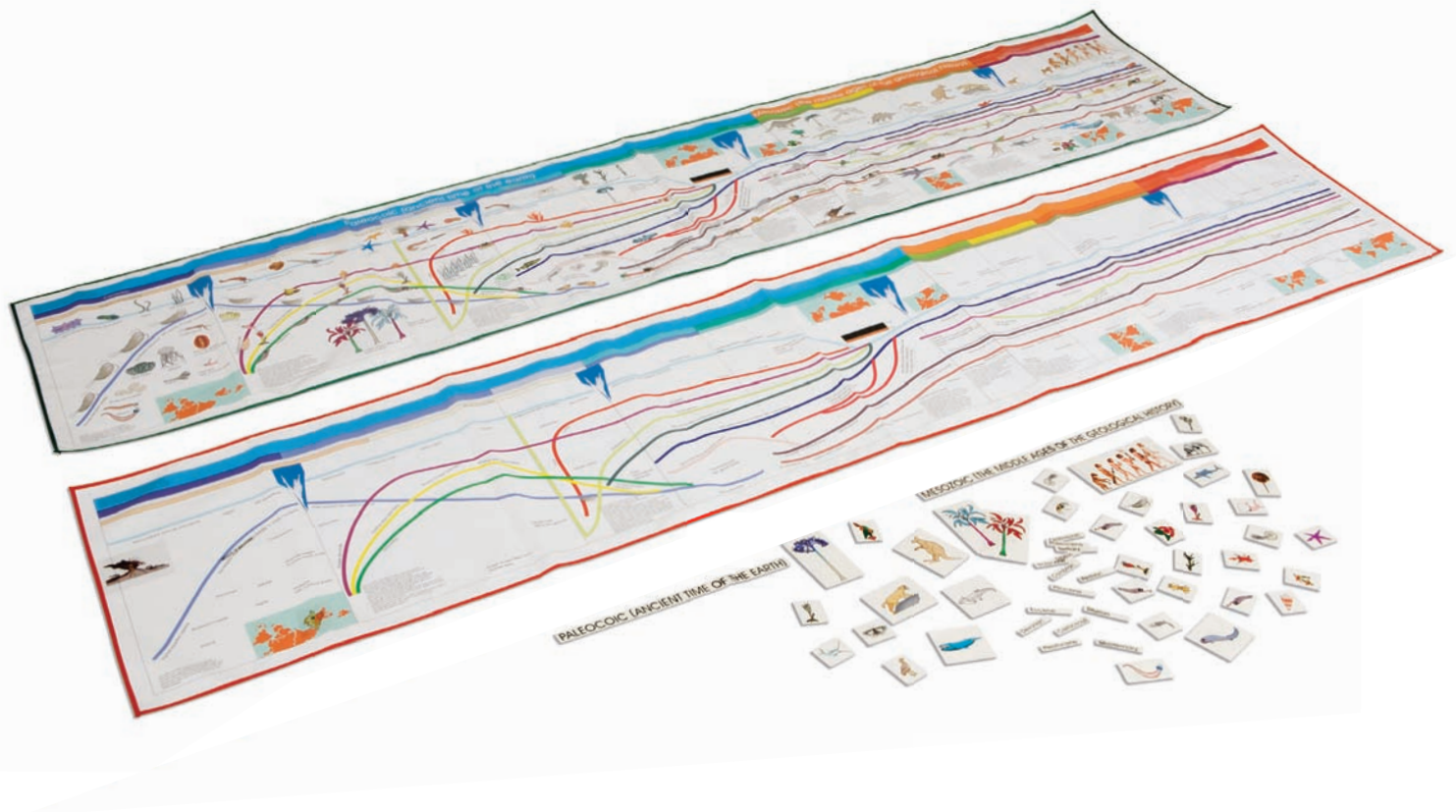

### **Evolution Time Line**

The time line of life represents the beginning of life on earth from the simplest forms through the appearance of human beings. A great variety and magnificence of life is presented, with each organism a contributor to a vast cosmic scheme. It traces the Palaeozoic, Mesozoic, and the Cainozoic periods, beginning with the kingdom of Trilobites and ending with the human being. The teacher indicates on a time line where vertebrates began, followed by fish and plants, then amphibians, reptiles, birds, and mammals. This time line is the basis for lessons in chemistry, nutrition, categories of animals and plants, care and requirements of different animals, and their interrelationship with an ecological system. Students are introduced to formal scientific language of zoology, botany, and anthropology. Set includes: 2 time lines - 1 with text and pictures, and 1 without (lines only) made of a coated fabric (measuring 57 x 240 cm) and a wooden box with transparent word cards and pictures for use on the time line.

**Item Number: 0.696.01**

## Time Lines

**The Rolling Calendar**

Developed in a Montessori classroom, this wall mounted, interactive calendar personalizes time by creating a daily record of the children's writing and drawing. With The Rolling Calendar, children are exposed to the concept of time. A full week can be presented. The sliding guide can be used to separate the past (on the left) and the future (on the right). Through use, the children gradually grasp the idea of abstract concepts of time, such as today, tomorrow, yesterday, last week, etc. Includes: a beechwood base with 2 spindles and a sliding guide (95 x 13 cm), a bracket for mounting The Rolling Calendar to a wall and 1 roll of paper.

**Item Number: 0.855.00**

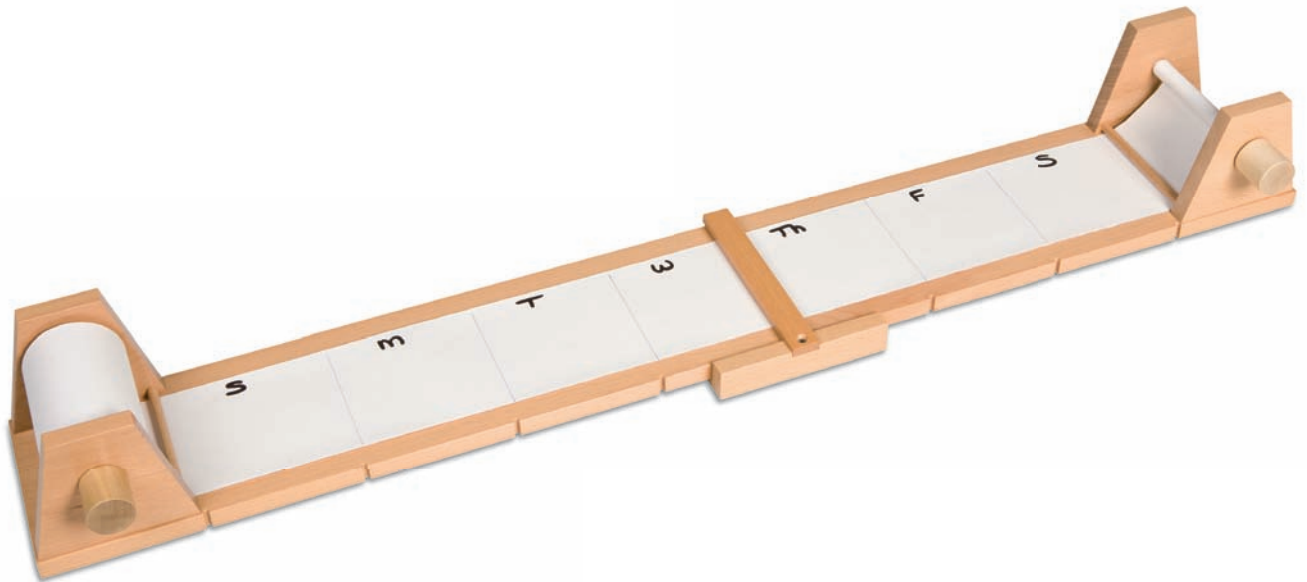

**Roll Of Paper: The Rolling Calendar**

**Item Number: 0.855.50**

**Small Wooden Scale**

This scale is specially designed for young children as an initial introduction to the concepts of weight and balance. Weights are ordered separately (9.124.00).

**Item Number: 9.129.00**



**10 Weights in Wooden Storage Block**

10 weights for use with the Small Wooden Scale (9.129.00) and other classroom activities.

**Item Number: 9.124.00**

## Weight And Measurement

### Measurement Material

The idea of this material is to teach the various units of measurement, weights, liters, volume and area. It is best if the children know the basic concepts of measurement before working with this material. Authors: Rob Weichelt and Corine van der Veen.



### Chart For Measurement

Includes: one Chart For Measurement, a box with lid containing: 20 exercise cards, 10 tiles printed with numerals 0 - 9, 7 tiles printed with measurements mm - km and one green skittle.

**Item Number: 2.005.01**

### Chart For Area

Includes: one Chart For Area, a box with lid containing: 20 exercise cards, a strip printed with  $\text{mm}^2$  to  $\text{km}^2$ , a strip printed with ca to ha, 10 tiles printed with numerals 0 - 9 and one green skittle.

**Item Number: 2.006.01**

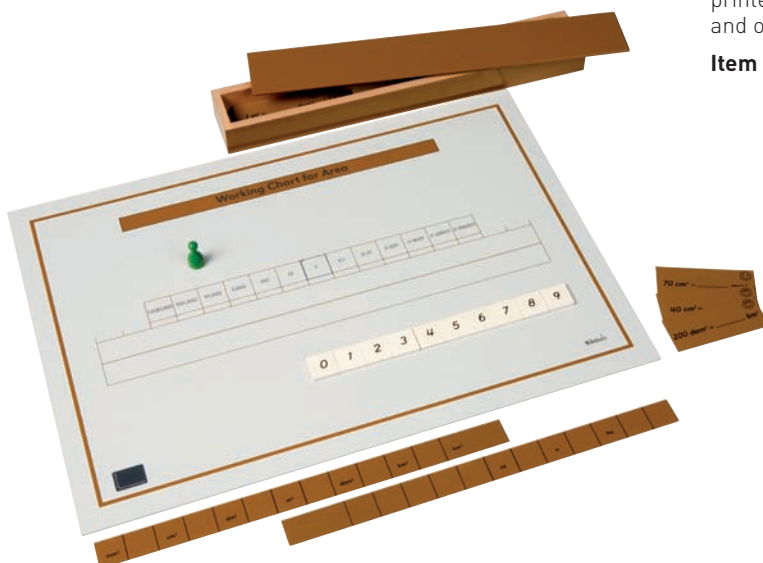

**Chart For Calculation Of Volume**

Includes: one Chart For Calculation Of Volume, a box with lid containing: 20 exercise cards, a strip printed with mm<sup>3</sup> to km<sup>3</sup>, a strip printed with ml to kl, 10 tiles printed with numerals 0 - 9 and one green skittle.

**Item Number: 2.007.01**



**Chart For Weight**

Includes: one Chart For Weight, a box with lid containing: 20 exercise cards, 10 tiles printed with numerals 0 - 9, 7 tiles printed with mg - kg and one green skittle.

**Item Number: 2.008.01**



## Weight And Measurement

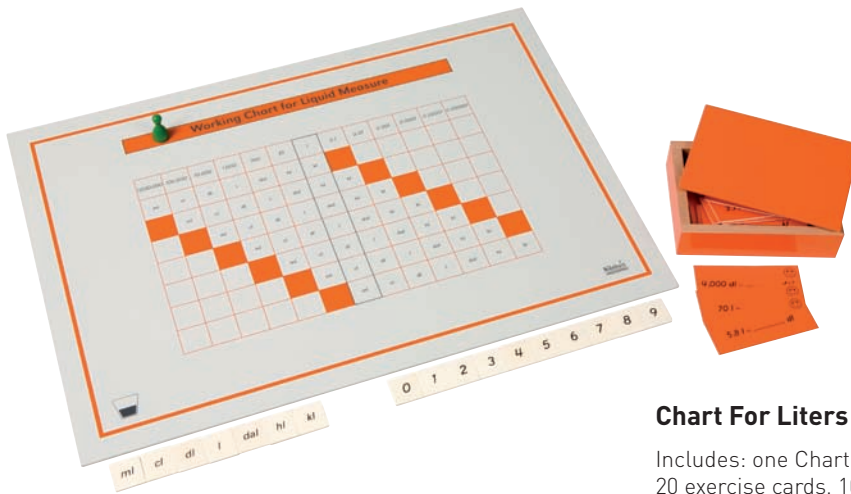

### Chart For Liters

Includes: one Chart For Liters, a box with lid containing: 20 exercise cards, 10 tiles printed with numerals 0 - 9, 7 tiles printed with ml - kl and one green skittle.

**Item Number: 2.009.01**



### Exercise Chart: Measurement Material

Contains one Exercise Chart for use with the measurement material.

**Item Number: 2.010.01**

### Chart With Explanation Of The Abbreviations

Contains one chart used as a control. Explains the abbreviations used in the charts.

**Item Number: 2.010.51**





**Solaris**

The Solaris clock turns telling time into a creative activity. Children can build their own clock using the Solaris components. There are several interchangeable faces - Arabic numerals, Roman numerals, divided into minutes and a sundial. These clock faces are commonly found in everyday life. Introducing the concept of time as a function of the sun and the rotation of the earth opens to the children to an entirely new perception of time concepts and their relationships. The supplied compass is needed to orient the clock to North and introduces the concept of direction on the planet's surface (also known as "magnetic" North). The many applications of this truly unique material are a valuable addition to any classroom. Includes: 1 clock (37 x 31 x 10 cm) with a storage compartment for the clock faces, 4 interchangeable clock faces in different colors (diameter 27 cm), 2 removable clock hands, 1 sundial pointer, 1 compass, 1 whiteboard marker and instructions.

**Item Number: 3.150.00**



## Time

### Clock With Movable Hands

A freestanding Clock With Movable Hands and removable clock numbers 1-12 in red and 13-24 in blue used for teaching children to tell time. Includes: a stand with a storage tray and lid for storing the numbers. Diameter of the clock face is 28 cm.

**Item Number: 3.100.00**



### The Clock Exercise

The Clock Exercise introduces the concept of time. It develops visual perception as well as language. Time is presented as 4 segments: the whole hour, a quarter past the hour, half past the hour and a quarter to the hour. Each of the individual 'faces' is a wooden tablet with the time shown both in the hands position and with the name written at the bottom of the tablet. The working stands have a slot for holding the tablet while at the same time, hiding the printed words on the bottom. The separate labels can be set on the stand in front of the "face" as the child names the time. The faces and labels are printed in 4 colors for coding and separating the exercises. Includes: 48 face tablets, 48 label tablets, 2 working stands, a wooden box with compartments and instructions.

**Item Number: 3.101.01**



**Clock Stamps**

Rubber stamps with several versions of clock faces - 12 hour, 24 hour, Roman Numerals, Blank, 12 hour digital, and 24 hour digital. Used as an aid in teaching children to tell time. An ink pad and a box for storing each stamp may be purchased separately.



**Clock Stamp: 12 Hour**  
Item Number: 3.102.00



**Clock Stamp: 24 Hour**  
Item Number: 3.103.00



**Clock Stamp: Roman Numerals**  
Item Number: 3.104.00



**Clock Stamp: Blank**  
Item Number: 3.105.00



**Clock Stamp: 12 Hour Digital**  
Item Number: 3.106.00



**Clock Stamp: 24 Hour Digital**  
Item Number: 3.107.00

**Clock Stamp: Box For Storage**  
Item Number: 3.109.00



**Clock Stamp: Ink Pad**  
Item Number: 132.031

## Motor And Tactile

### Grippy

The main objective of Grippy is that of recognizing objects through the sense of touch. Includes: a red board with holes, 20 knobs made of different shapes and types of wood, two small bags and instructions. The board is equipped with a rope, so it can be suspended. Author: R. Wienert

**Item Number: 3.400.00**



### Senso

Senso is a tactile matching game which develops perceptual skills as the child feels and discriminates different textures and shapes. Children of all age groups will enjoy Senso. For up to 4 players. Contents:

- 4 wooden game boards with 9 squares of different shapes and textures printed on each board in flint-grain. All the boards are color-coded to make sorting the game pieces easier for the child
- 36 wooden squares with each of the patterns on the game boards printed in flint-grain.
- a wooden tray
- instructions

**Item Number: 3.201.00**

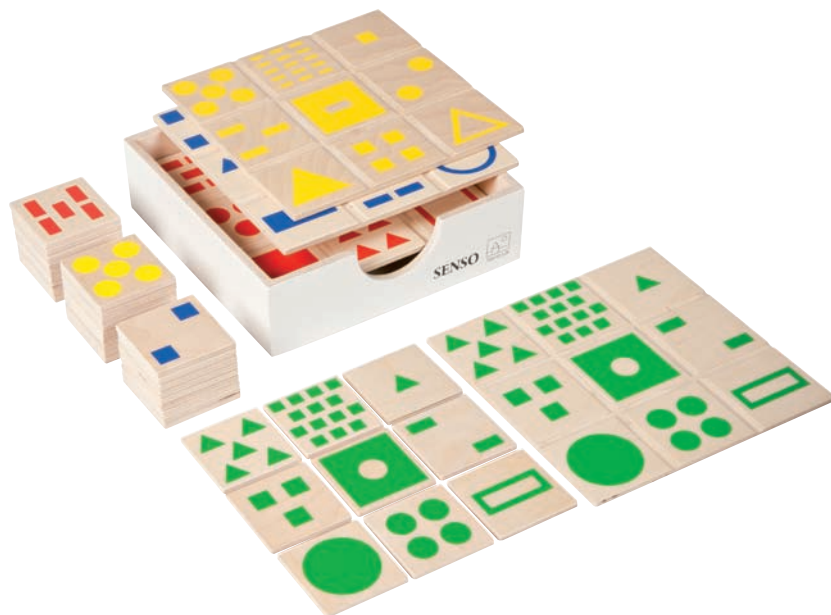



**Senso Junior**

Senso Junior is a tactile matching game which develops perceptual skills as the child feels and discriminates different textures and shapes. Senso Junior practices building skills in visual discrimination. Children also will experience working with mirror-images when checking the result of the exercise.

Contents:

- a box with a lid (21 x 21 x 5.5 cm)
- 4 wooden game boards with four squares with different shapes printed on each board in flint-grain
- 16 wooden squares with 4 different shapes, printed in flint-grain
- a plastic mirror
- instructions

**Item Number: 3.265.00**

**Sensidisc**

Playing with Sensidisc helps children practice tactile and visual perception through sensory-motor activities. It also helps train the memory and develop social skills. By feeling, the child discovers various shapes and structures, which it learns to recognize and describe.

Contents of each:

- 1 game board (48 x 20 cm)
- 10 discs (8 cm)
- 10 shapes
- 1 bag
- instructions

**Sensidisc: Geometric Shapes**

**Item Number: 3.028.00**

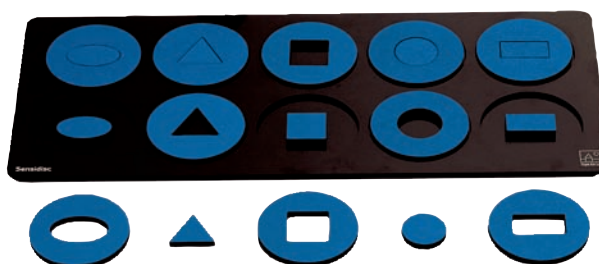

**Sensidisc: Structures**

**Item Number: 3.029.00**



## Motor And Tactile

### Tactile Materials

Using their sensory perception, children explore the world around them. With a sense of touch, they discover various shapes and features of objects. One can feel whether an object is hard, soft, sharp, large, small, etc. By giving names to the various objects, children expand their vocabulary. An exciting touching, guessing, and searching game can be played with the sets of tactile materials and the matching cards.



**Tactile Box**  
Item Number: 522.873

#### Tactile Box: Materials Set 1

- 10 geometric shapes
- 10 cards with matching pictures
- plastic box  
(Tactile Box not included)

Item Number: 3.243.00



#### Tactile Box: Materials Set 2

- 12 varied objects
- 12 cards with matching pictures
- plastic box  
(Tactile Box not included)

Item Number: 3.244.00



**Vetrovorm: Threading Game**

Through 'threading' the colored strings through the pattern cards, the children create interesting pictures and patterns, as well as develop their hand-eye coordination. After they have mastered threading with the supplied pattern cards, the children are encouraged to create their own designs to thread on the supplied blank cards.

Contents:

- wooden box with lid (35 x 19 x 8 cm)
- 12 plastic cards with printed patterns or designs (16 x 16 cm)
- 6 blank plastic cards (16 x 16 cm)
- 24 colored string laces

**Item Number: 522.462**

**Vetrovorm: Additional Laces (24)**

**Item Number: 522.576**

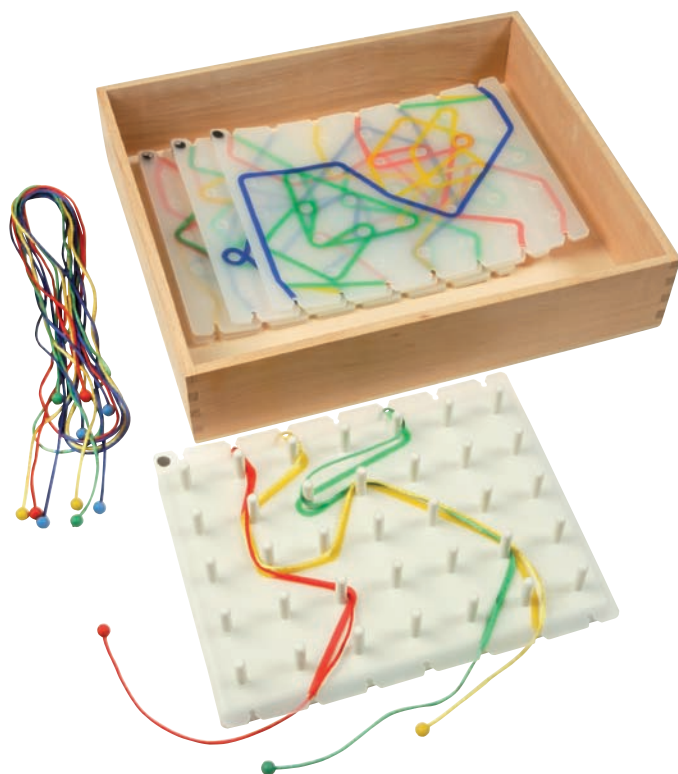

**Rope Figures: Thread Design Board**

Rope Figures is an exciting game where children create colorful patterns through 'following' the ropes on the pattern cards. By placing the transparent control card over the pins on the game board, the children see the route of the ropes and try and duplicate their path. The control cards are divided into 3 levels of difficulty.

Contents:

- a wooden box
- game board
- 16 control cards (28 x 23 cm)
- 8 colored ropes (2 each of 4 colors)

**Item Number: 522.940**

## Motor And Tactile

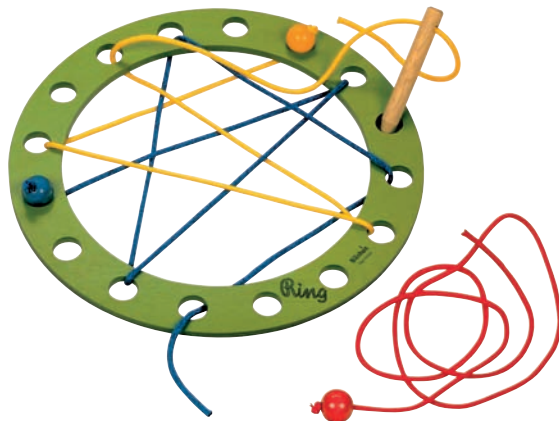

### Ring

With a ring and a string children develop their hand-eye coordination and invaluable manipulative skills while having fun! By using the easy-to-grasp wooden needle and threading colorful strings through large holes in the ring, the child creates patterns. Through play with Ring, fine motor skills for more complex activities such as folding, cutting, pasting and handwriting are developed.

Contents:

- a colorful wooden ring
- 3 colored laces
- a safe wooden needle
- instructions

**Item Number: 3.424.00**

### Skribi

With Skribi children practice hand-eye coordination. Writing is prepared by making large writing motions on the playing board. It is fun and exciting to play Skribi alone or with others.

Contents:

- a box with a lid (50.5 x 33 x 3 cm) with holes, used as playing board
- 3 playing cards (49 x 31.5 cm)
- 4 transparent cups: 2 large and 2 small
- 10 marbles in 2 colors
- instructions

Author: C. Campanario

**Item Number: 3.251.00**



### Skribi: Supplementary Set

3 playing cards. With these cards it is also possible for children to practice with both hands. Practicing coordination between the left and the right hand is an important preparation for writing.

**Item Number: 3.251.A0**





### Draw What's Missing: Set 1

It is a challenge to discover where 'the mistake is' and ... to correct it. Concentration, great attention to detail and good observation skills are taught with using Draw What's Missing. The children observe the card, figure out 'what is missing' and fill in the missing part with the included pen. There are also 'connect the dot' exercises included in the set. As the children work through the series of exercises, their precise motor skills are further developed as well. Once these exercises are mastered, the children can move on to Set 2 for further difficulty.

Contents:

- a wooden box with lid (27 x 22 x 2 cm)
- 3 cards with 36 exercises: 'draw the missing items'
- 3 cards with 24 exercises: 'connect the dots'
- 1 felt-tip pen (water-soluble)
- instructions

**Item Number: 3.726.00**

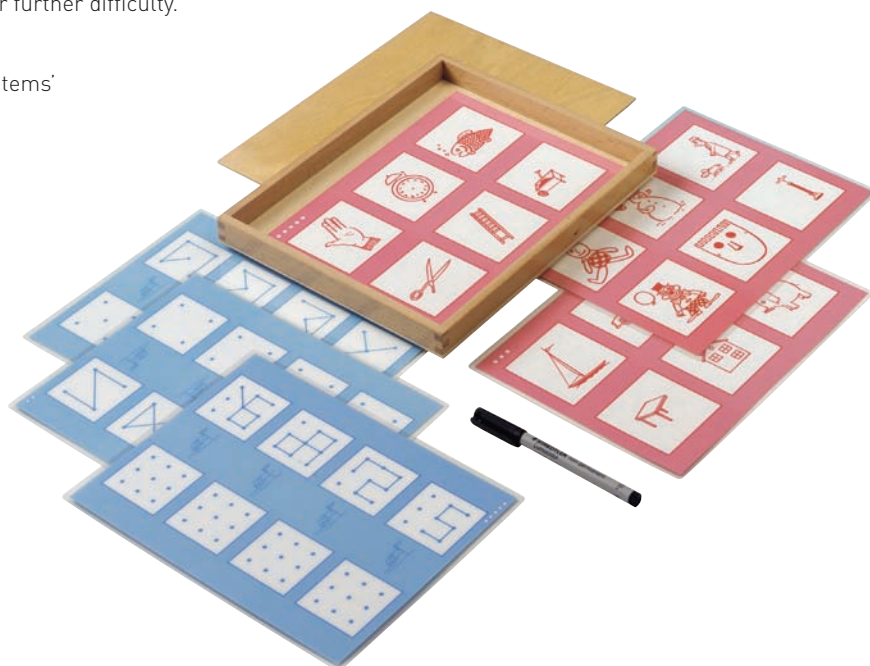

### Draw What's Missing: Set 2

The primary aim of this set is the stimulation of visual observation. This is done by identifying and then completing the missing parts in the illustrations. In particular, finishing mirror-image illustrations. It helps to exercise the left-right distinction and spatial orientation in a flat space. The latter is particularly important for properly distinguishing letters and figures, for example: bone and done, form and from and figures such as 12-21, 13-31, etc.

Contents:

- a wooden box with lid (27 x 24 x 2.8 cm)
- 6 plastic cards printed on two sides, with 12 illustrations
- 6 felt-tip pens (water-soluble): black, brown, red, blue, green and orange
- instructions

**Item Number: 3.093.00**



## Motor And Tactile

### Rubando

Using Rubando, children practice learning to tie their shoes through two exciting games. For those who learn to tie their own shoes, the teacher can issue a 'Shoe-Tying Certificate'. (Rubando Board Stand sold separately).

Contents:

- 4 shoelace-tying boards
- 1 die with shoelace-tying symbols
- 1 die with 2 black dots
- 1 'Shoe-Tying Certificate' copying card
- instructions

Author: B. Bothe

**Item Number: 3.005.00 – Rubando: Basic Set**

**Item Number: 3.005.10 – Rubando: Board Stand**



### Hand-Eye Coordination

The cards, made of high quality plastic, contain a series of exercises designed to train hand-eye coordination systematically.

Contents:

- a wooden box with lid (28 x 23 x 2 cm)
- 30 exercise series on 15 cards, printed on both sides
- 1 felt-tip pen (water-soluble)
- instructions

**Item Number: 3.715.00**



**Kwinto Motor Skills Set**

Kwinto is a multifunctional box containing various games, specifically developed to aid in the development of controlled voluntary movements necessary in the preparation of writing. The specific aims are designed to encourage: the mobility and function of fingers and hands, hand-eye coordination, development of right or left-handed writing preference, relaxed writing motion, spatial orientation and concentration.

Contents:

- a yoyo
- felt-tip pen
- a catching cup
- an hourglass
- tiddlywinks
- a soft ball
- a small top
- a spinning disc with a string
- a box with 50 cubes
- a box with counters
- 3 pattern cards
- spills sticks
- a round card with a scoring system designed for use as a target for the ball and tiddlywinks games
- instructions
- a beech wood box with lid that can be used as a drawing board and for storing the above contents.



Author: Henk Schweitzer.

**Item Number: 2.002.00**



**Kwinto Stereoboard**

There is more involved in the preparation of writing than practicing writing patterns. The child first must be able to discriminate spatial orientation (left, right, top, bottom). Holding a writing instrument correctly, a natural writing posture, well developed hand-eye coordination, and hand and finger movement are additional conditions that must be present when learning to write.

Contents:

- a beech wood frame (55 x 55 x 10 cm) with a transparent whiteboard
- 2 whiteboard markers
- instructions

Author: Henk Schweitzer

**Item Number: 2.001.00**

**Kwinto Whiteboard Markers: 10**

**Item Number: 2.001.50**



## Motor And Tactile

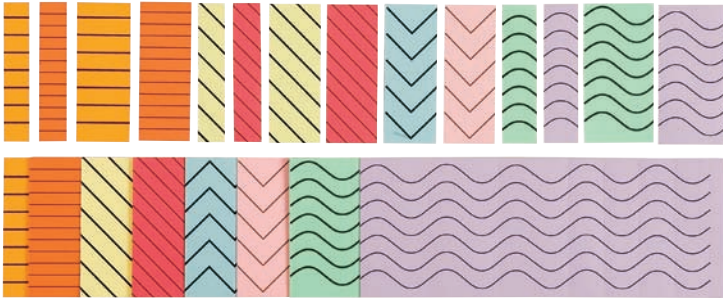

### Scissors Exercises

14 sequential exercises used for the development of scissors mastery. Narrow strips are for single-cut exercises and wide strips for multiple cuts. 14 different strips provide progressive levels of difficulty. Includes: micro-perforated pads for easy removal of individual cutting strips and convenient storage, 3400 strips: 8-10/sheet, 50 sheets/pad and instructions.

**Item Number: 5.677.00**

### Building Blocks: Multi Colored Wood

A selection of 100 bright colored building blocks in a variety of shapes to encourage imaginative construction play. The blocks have different shapes and sizes and are packed in a sturdy wooden box. (30 x 21 x 8 cm).

**Item Number: 522.413**



### Building Blocks: Natural Wood

100 blocks in different shapes. Supplied in a cotton bag.

**Item Number: 522.480**



## Observing And Understanding

### Arbio

Children everywhere are familiar with trees, where they live, at school, where they travel and camp. Arbio takes advantage of the child's natural interest in nature, in particular trees, and offers the opportunity to study and learn about the differences and characteristics of trees. The child is challenged to find the correct "whole" tree by examining the trees, fruits or leaves and fitting together two pieces.

Contents:

- a wooden box with lid
- 24 wooden tablets showing the 12 trees in summer on one side; winter on the other
- 24 wooden tablets showing 12 types of leaves
- 24 wooden tablets showing 12 different tree fruits
- 1 control card
- instructions

**Item Number: 3.234.00**



### Arbio: Supplementary Set

A set containing 24 cardboard cards showing the trees in winter and 12 name cards giving the common as well as the Latin name of the trees. Includes: a plastic box for storage.

**Item Number: 3.234.06**



## Observing And Understanding

### Papilo

Papilo teaches children about shape and color comparison as well as encourages discussions about butterflies, the different species, their life cycle and the different types of plants they prefer. When put together, the pieces form a beautiful circle of butterflies.

Contents:

- a wooden box with lid
- 36 tablets with partial illustrations of 6 different butterflies
- 36 pieces with partial illustrations of 6 different plants
- instructions

**Item Number: 3.264.00**



**Papilo: Coloring Pad (50)**  
**Item Number: 3.264.01**

**Legumo**

Legumo is a lotto depicting whole and sliced vegetables. Vocabulary development, memory and knowledge of the different varieties of vegetables are learned through play.

Contents:

- a wooden box
- 4 lotto boards
- 24 tablets with pictures of whole vegetables
- 24 tablets with pictures of sliced vegetables
- instructions

**Item Number: 3.830.00**



**Frutty**

Frutty is a lotto depicting whole and sliced fruits. Vocabulary development, memory and knowledge of the different varieties of fruits are learned through play.

Contents:

- a wooden box
- 4 lotto boards
- 24 tablets with pictures of whole fruits
- 24 tablets with pictures of sliced fruits
- instructions

**Item Number: 3.831.00**



## Observing And Understanding

### Dresscode

Dresscode is an original game on the theme of clothing. Logical thinking and problem-solving are practiced through play and children learn to work with features and requirements. The child lays the correct sets of clothing next to the instruction card on the play board and checks his or her solution.

Contents:

- a wooden box with lid (35 x 18 x 5 cm)
- 8 instruction cards at 3 levels
- 19 clothing sets
- 3 play boards
- instructions

Author: Meeple

Item Number: 3.002.00



### Criteria

Criteria is a game in which the following concepts are addressed: logical thinking, features, differences and correspondence. The instruction cards show four pictures. Each picture does not belong with the other three for its own unique reason. The player places the right pictocards next to the pictures to show what this unique reason is. Criteria is self-checking.

Contents:

- a wooden box with lid (35 x 18 x 5 cm)
- 18 instruction cards at 3 levels
- 12 pictocards
- instructions

Author: Meeple

Item Number: 3.001.00





**Diario**

Children can exercise many skills by playing with Diario, the daily routine game. One important skill is the ability to organize activities within a time frame. Diario emphasizes the what and when of successive daily activities in a playful manner. Visual observations are stimulated by examining the game board and all the related game cards. To decide which card belongs to a particular time of day, the child has to utilize and therefore train his/her memory. In the end, the game helps train social skills because there is much to see, discuss and consider. The material is self-checking.

Contents:

- a wooden box with lid (28.5 x 25 x 3 cm)
- 1 six-sided game board (27 x 23 cm)
- 36 cards: six for each of the six parts of the day
- 1 spinner
- instructions

Author: C. den Dulk

**Item Number: 3.077.00**



**Feelings And Emotions**

Children learn important emotional skills at an early age: learning to mimic, using words and gestures to express feelings; learning to recognize and understand their own feelings and those of others, so they can get along better and easier with others. With 'Feelings And Emotions', children are encouraged to act out and talk about feelings in general, as well as their own feelings, in a playful manner.

Contents:

- a wooden box with lid (33.9 x 33.9 x 40 cm); the lid serves as the game board
- 20 situation cards with a green edge (5 illustrations for each basic emotion)
- 32 yellow emotion cards
- 4 colored markers
- 4 card holders
- 1 die with dots from 1 to 6
- instructions

Author: C. den Dulk

**Item Number: 3.092.00**



## Observing And Understanding

### Bas Lottos

Playing with the Bas Lottos helps exercise various skills. Children learn how to observe and recognize the parts and the whole of objects. They develop language skills by talking about and naming the illustrations. Moreover, they are encouraged to talk about their own experiences in situations similar to those illustrated. The various themes tie in perfectly with the experiences of young children. The material is self-checking.

Contents:

- a wooden box with lid
- 4 lotto boards with a control on the reverse side
- 48 small boards
- instructions

©: Uitgeverij Groen

**Item Number: 3.047.00 - Bas Lotto: Set 1 - Bas At Home**

**Item Number: 3.048.00 - Bas Lotto: Set 2 - New Experiences**

**Item Number: 3.049.00 - Bas Lotto: Set 3 - Holiday Adventures**

**Item Number: 3.062.00 - Bas Lotto: Set 4 - Bas Going Places**



**Citadel**

The houses are placed on the game board by looking at and comparing them. Citadel is a game for children who already have some experience in sorting according to size and determining position. These are two important basic skills needed to learn to read, write and do arithmetic. Children also develop logical thinking, spatial awareness and learn to cooperate and help each other when doing assignments. The material is self-checking.

Contents:

- a wooden box with lid (25.5 x 25.5 x 3 cm)
- a game board (22.5 x 22.5 cm)
- 12 houses in 4 colors and 3 sizes
- 16 assignment cards (4 sets of 4), self-checking on the reverse side
- 4 control cards
- instructions

**Item Number: 3.054.00**



**Symetrix**

By playing with Symetrix, children practice their visual perception by 'reading' and carrying out the assignment. In addition, the child learns to deal with concepts of order and spatial orientation. The child logically analyzes what is observed and converts these observations into fine motor activities. The game stimulates social development by requiring a high degree of cooperation. The material is self-checking.

Contents:

- a wooden game board (26 x 26 x 1.5 cm)
- 2 mirror supports
- 2 plastic mirrors (14 x 14 cm)
- 20 plastic assignment cards
- 1 card holder
- 20 colored wooden counters
- 1 cloth bag
- instructions

**Item Number: 3.041.00**

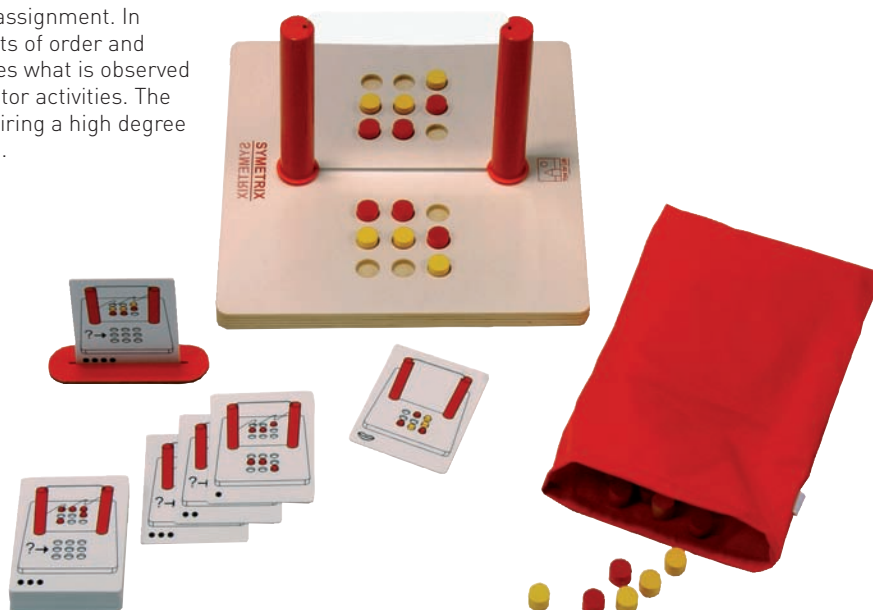

## Observing And Understanding

### Mini, Midi, Maxi

Learning to see and experience the differences between small, larger and the largest. Language plays a key role in this material. The following concepts are encountered during play: smallest, largest, larger than, smaller than, equally large, etc. The material is self-checking.

Contents:

- a wooden box with lid (24 x 24 x 6 cm)
- 36 wooden figures
- 24 assignment strips with control on the reverse side
- 9 cards for the matrix game (size and figures)
- 4 small game boards
- 8 assignment cards for the board game
- 4 wooden stands
- instructions

Item Number: 3.050.00



### Spatial Relations

Growing children experience spatial notions daily. They start with concrete situations, which often happen unconsciously. The parent or teacher stimulates linguistic conceptual development by manipulating the spatial situations more consciously and more explicitly, by giving specific assignments.

Contents:

- 2 nesting wooden boxes with 1 lid (32 x 20 x 3 cm)
- 56 wooden tablets
- instructions

Item Number: 3.723.00





**Ritmo**

The objective of Ritmo is to help children learn to discriminate and recognize sounds. Various sounds are produced that the children try to recognize and then find the appropriate illustration to match the sound.

- Contents:
- a wooden box with lid (27.5 x 12 x 3.5 cm)
  - 16 cards
  - 32 assignment strips
  - 1 card holder
  - instructions

Author: L. Bos

**Item Number: 3.031.00**

**Concentra**

Concentra is a picture puzzle in sudoku style. While playing with Concentra, children train their thinking and combination skills, as well as stimulate their concentration and analytical sense. There are 3 levels of difficulty per puzzle: "easy", "difficult" and "very difficult". The material is self-checking.

- Contents:
- a wooden box with lid (27.6 x 24 x 2.8 cm)
  - 6 coded game boards
  - 60 picture cards
  - 6 coded control cards
  - instructions

Author: M. Junga

**Item Number: 3.095.00**



## Observing And Understanding

### Duo Lotti

When playing with Duo Lotti, children exercise various skills. Among others, the lotto game fosters observation and language development. Because this game has several variations, it is also very challenging.

Contents:

- a wooden box with lid (24 x 24 x 3.5 cm)
- 4 game boards (20 x 20 cm)
- 64 single cards (4.5 x 4.5 cm)
- 32 cards with two illustrations (9 x 4.5 cm)
- instructions

Author and illustrator: L. Bos

**Item Number: 3.075.00**



### Parcours

With Parcours children practice many skills. As they 'read' the route cards, their visual perception is being trained. The perceptions go through a logical reasoning process and are converted into delicate hand-eye coordination and visual tracking as they follow the route. Learning to observe carefully and hand-eye coordination are prerequisites for learning to read, write and do sums.

Contents:

- 1 game board (37 x 37 cm)
- 4 cars and 4 red counters
- 1 number and 1 color die
- 48 playing cards
- 1 cotton bag
- instructions

Author: L. Bos

**Item Number: 3.033.00**



### **Panoramix: Geometric Shapes**

Panoramix is a fun and interesting game, which develops the child's perceptual skills and stimulates language development. Many of the prerequisite skills for reading, writing and arithmetic such as visual memory, auditory discrimination, spatial awareness, memory skills and logical thinking are experienced with the numerous activities possible with this game.

Contents:

- a wooden box with lid (24 x 20 x 7.5 cm)
- 2 wooden stands
- 36 geometric shapes
- 32 assignment cards
- a white background plate
- a cotton bag
- instructions

Author: L. Bos

**Item Number: 3.034.00 - Panoramix: Geometric Shapes**

**Item Number: 3.036.00 - Panoramix: Additional Shapes & Cards (Geo)**

**Item Number: 3.038.00 - Panoramix: Additional Stands (2)**



### **Panoramix: House - Tree - Animal**

This is the easier version of Panoramix. Basic skills such as visual perception and spatial awareness are learned when working with this set.

Contents:

- a wooden box with lid (24 x 20 x 7.5 cm)
- 2 wooden stands
- 12 figures
- 20 assignment cards
- a white background plate
- a cotton bag
- instructions

Author: L. Bos

**Item Number: 3.035.00 - Panoramix: House - Tree - Animal**

**Item Number: 3.037.00 - Panoramix: Additional Shapes & Cards (House)**

**Item Number: 3.038.00 - Panoramix: Additional Stands (2)**



## Observing And Understanding

### Casita

The aim of Casita, is to exercise visual observation and concentration. Describing the illustrations stimulates speech development and increases the vocabulary. Many of the prerequisite skills for reading, writing and arithmetic such as visual memory, auditory discrimination, spatial awareness, memory skills and logical thinking are experienced with the numerous activities possible with Casita.

Contents:

- a wooden box with lid (34.6 x 18.6 x 4.8 cm)
- 4 wooden houses, each with 2 stands
- 48 illustrated cards
- 16 coded assignment cards
- instructions

Author: Michalina Nowakowska

Item Number: 3.045.00



### Listen Well

When playing with Listen Well, children are taught important learning concepts. Skills such as, spatial awareness, concentration, comprehension, recognition of ordinal numbers and vocabulary are put to a test as they learn to critically listen to short stories. The children take a set of assignment cards and place them in a row in front of them. Next, they listen to the story on the CD and answer the questions put forth. For example: they hear the following question: "on what picture is the duck standing in front of its pen?" The child would then take a look at the pictures sitting in front of them and select the one that they think is correct, and place it in the tray. When all eight questions are answered, and all the cards are in the tray, the lid is closed and the tray is turned over. When the lid is removed from the tray, an image is revealed. If the image is complete, the exercise was done correctly. This material is self-checking. (Listen Well Tray sold separately 523.007).

Contents:

- a wooden box with lid (34 x 20 x 5.5 cm)
- 64 assignment cards
- CD
- instructions

Item Number: 522.928 – Listen Well

Item Number: 523.007 – Listen Well: Tray





**Okidee**

Okidee helps children practice forming ideas at various levels. Quantity, shape, position and direction are dealt with. The structure of the exercises present these ideas first in concrete form and afterwards, more abstractly.

Contents of each set:

- one box with a slot (35 x 11 x 3 cm)
- one lid, which serves as the working top (35 x 9.5 cm)
- 8 printed plastic exercise strips (33 x 8 cm)
- 24 printed plastic answer cards (7 x 5.5 cm)
- instructions

© Annemariet van Beers (1983) c/o Beeldrecht, Amsterdam

**Okidee: Direction**  
Item Number: 3.304.00



**Okidee: Quantity**  
Item Number: 3.306.00





**Menu**

Good nutrition is important for everyone. With Menu, children will learn to recognize the nutritional groups and where the products come from. That milk comes from the cow and not from the factory, the egg from the chicken, etc. Through play and talk, children can have fun learning how to eat a varied and healthy diet.

Contents:

- a wooden box with lid (23.5 x 15.5 x 7 cm)
- 2 series of 36 printed boards (7 x 5.5 cm)
- 6 printed hexagons
- 1 spinner
- instructions

**Item Number: 3.020.00**



**Mini Memo**

Mini Memo helps children to: develop their motor reflex skills, learn to recognize similarities and differences in shape, color and size, train their memories, and develop social skills by playing with others.

Contents:

- a blue lacquered box (31 x 31 x 3.5 cm)
- a plastic cover (the game board)
- 16 small yellow plastic cups
- two sets of 16 objects
- instructions

**Item Number: 3.212.00**



## Observing And Understanding

### Transparanto

Transparanto is a fanciful lotto for young children. Transparanto helps develop observation of shapes and vocabulary and children learn to combine two parts into complete picture.

Contents:

- a wooden box with lid (22 x 13.5 x 4 cm)
- 4 plastic lotto cards (19.5 x 11 cm)
- 24 transparent cards (6.5 x 5.5 cm)
- a cotton bag (28.5 x 18 cm)
- instructions

**Item Number: 3.014.00**



### Grimas

Besides spoken language, facial expressions play an important role in communication. It is almost impossible to express emotions without them. Grimas is a fun game for young children, designed to help them learn to express their feelings without spoken language.

Contents:

- a plastic case (26 x 20 x 5 cm)
- four wooden stands
- 30 cards: 25 each with different faces and 5 auxiliary cards
- a mirror
- five different attributes: a pair of spectacles, a headband, a plastic nose, a pair of earrings and a bow-tie
- instructions

**Item Number: 3.261.00**



**Memos**

Working with Memos stimulates the development of perception in the following areas: color, shape, pattern, quantity, and pictures of objects. Memos also aids in the development of memorization and motor skills. Since Memos is played with several children, it also contributes to social development. In addition, simple math skills are exercised by having the children count and compare the number of discs that each collected at the end of the game.

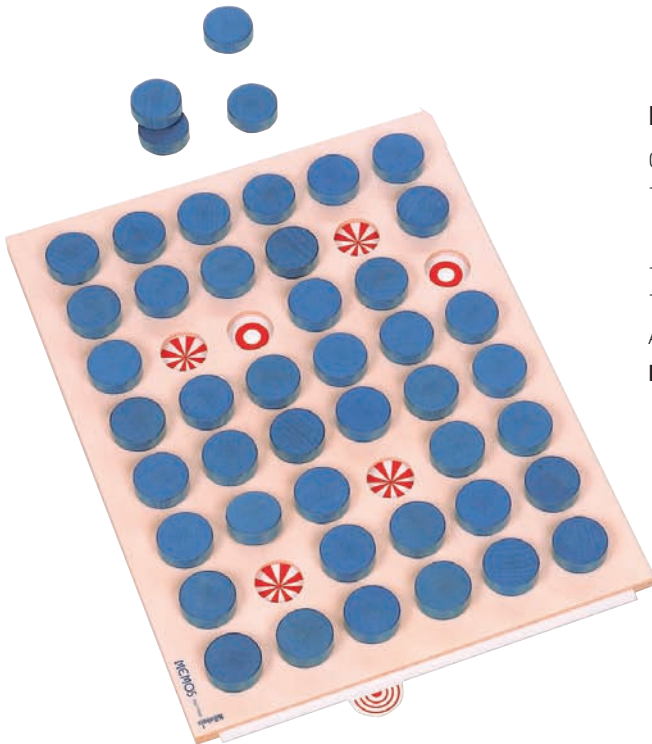

**Memos: Game Board**

Contents:

- a wooden game cassette with 48 holes to fit the wooden discs (39 x 30 x 1.2 cm). The exercise cards slide into the bottom of the game cassette (exercise cards not included).
- 48 wooden discs
- instructions

Author: M. Junga

**Item Number: 3.214.06**

**Memos: Exercise Cards - Memos 1**

Contents - 1 each of:

- geometric shapes
- toys
- color combinations
- musical instruments
- patterns
- means of transport
- counting
- animals

**- Item Number: 3.214.01**

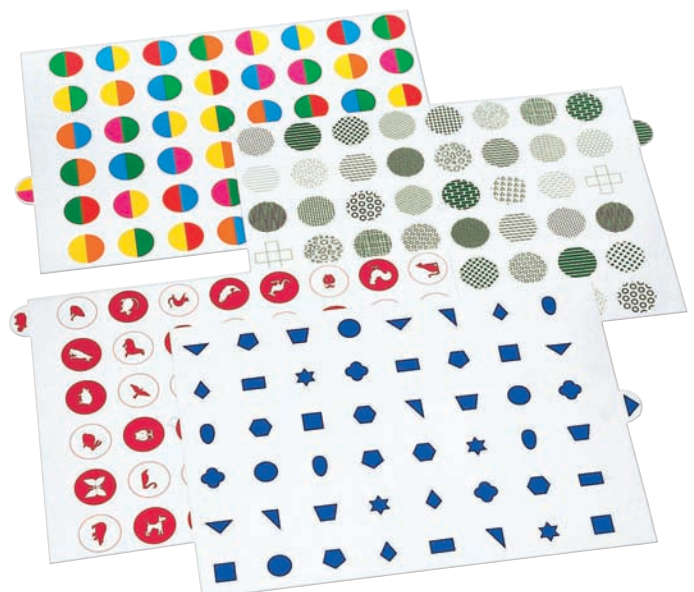

## Observing And Understanding

### Memos: Exercise Cards - Memos 2

Contents - 1 each of:

- geometric figures
- combinations of colors
- circles
- divided circles
- little house, little tree, little pet
- halves
- faces
- flags
- food and drinks

**Item Number: 3.214.02**



### Memos: Exercise Cards - Memos 3

Contents - 1 each of:

- symbols
- ladybirds
- balloons
- clocks
- familiar objects
- counting
- numbers
- letters

**Item Number: 3.214.03**



**Campolino**

Campolino is the name of a farmer whose farm is in shambles. The aim of this game is for the children to help Campolino tidy things up. When looking to see what belongs together, the children exercise logical combinations. Speaking and listening skills, concentration and memory are also exercised. Because the children work together and consult with one another, the game is good for practicing social skills.

Contents:

- a wooden box with lid (22.5 x 22.5 x 4 cm)
- 4 matrix boards (20 x 20 cm)
- 36 cards (5 x 5 cm)
- instructions

Author and illustrator: L. Bos

**Item Number: 3.074.00**



**Matrix Mix**

By playing with Matrix Mix, children exercise many skills: visual observation, logical connections, concentration and memory. The various subjects that the children encounter while playing the different games are: colors, sizes and quantities up to five. In addition, by playing together and discussing their answers, the children practice their social skills.

Contents:

- a wooden box with lid (33 x 33 x 4 cm)
- 4 coded game boards
- 4 sets of coded cards for the four game boards
- a spinner
- instructions

**Item Number: 3.094.00**



## Observing And Understanding

### Dubbeldam

Dubbeldam is a fun and interesting game which develops a child's perceptual skills and stimulates language development. Many of the prerequisite skills for reading, writing and arithmetic such as visual memory, auditory discrimination, spatial relationships, memory skills and logical thinking are experienced with the numerous activities possible with this game.



#### Contents:

The material is contained in a unique wooden box which both stores the material neatly and becomes the working area for the activities contained in the game.

Dubbeldam contains:

- 2 plastic charts printed with the background scene of the farm on one side and the town scene on the other side
- 2 plastic charts with the meadow for the farm scene on one side and the intersection for the town scene on the other side
- 2 charts with a grid of five times five squares on one side and ten times ten squares on the other

- 2 beechwood trays containing 52 brightly painted wooden objects, 2 object cards for sorting the number and type of objects into two matching sets, 1 dice with dots from one to three
- 20 activity cards with symbols in the lower right hand corner of the cards indicating the theme of the card
- 2 wooden stands to hold the activity cards
- a wooden partition consisting of two sections and a wooden block
- instructions

Author and illustrations: D. Strick

**Item Number: 3.850.00**





## Turn Over

Turn Over is a perceptual matching game. It provides a host of challenges in making logical relationships, and develops the basic skills necessary for reading, writing and arithmetic. Fundamental perceptual skills of directionality, visual discrimination, cause and effect relationships, and shape and pattern recognition are reinforced in these exercises. Turn Over has a built-in mechanism for self-correction. Turn Over is well suited for children 4 through 12 years of age.

### Turn Over: Board Only

Contents:

- a wooden board with pegs to hold the exercise cards
- 12 colored discs that fit around the perimeter of the board

**Item Number: 3.290.00**

### Turn Over Exercise Cards Sets.

Contents of each set:

- a wooden box with lid (21.5 x 21.5 x 2 cm)
- a set of 12 plastic exercise cards
- instructions

Author: A. van Beers c/o Beeldrecht, Amsterdam

**Item Number: 3.292.01 - Turn Over: Set 1**

**Item Number: 3.294.01 - Turn Over: Set 2**

**Item Number: 3.296.01 - Turn Over: Set 3**

**Item Number: 3.298.01 - Turn Over: Nature**

**Item Number: 3.299.01 - Turn Over: Time**

## Observing And Understanding

### Axi

Axi introduces children to the concept of time. The plastic illustrated cards present various daily activities that children perform throughout the day.

Contents:

- a wooden box (13 x 13 x 6.5 cm)
- 23 plastic, illustrated cards and 1 blank card, notched for hanging
- 5 meters of nylon thread
- 1 clip with a pointing hand printed on it
- instructions

Author and ©: Citogroep Arnhem

**Item Number: 3.941.00**

### Axi Plus

Axi Plus is intended for children in the third grade of primary school. The illustrations on the Axi Plus cards show daily activities. Through visualizing these activities, the children learn how to perform them.

Contents:

- a wooden box (23 x 18 x 5.5 cm)
- 21 plastic, color-printed cards
- 3 blank plastic cards
- 5 meters of nylon thread
- 1 pointer shaped like a hand
- instructions

Author and ©: Citogroep Arnhem

**Item Number: 3.946.00**



**Plan**

Plan is intended for the first two years of primary school. With Plan, children can make independent choices, plan their activities and through this, develop fixed play and work patterns. The illustrations on the Plan cards show play and work activities. By visualizing the activities, Plan is an effective tool for young children to plan their daily activities.

Contents:

- a magnetic activity board with hanging system (81 x 60 cm)
- a beech wood box (13 x 13 x 7.5 cm) containing 32 plastic, color-printed cards, 2 blank cards, 1 magnetic strip (roll), 40 magnetic bar-code strips for the name tags, 80 blank cardboard name tags
- instructions

Author and ©: Citogroep Arnhem

**Item Number: 3.942.00 - Plan: Magnetic Activity Board**

**Item Number: 3.943.00 - Plan: Box With Activity Cards**

**Item Number: 3.943.01 - Plan: Name Tag Holders (40)**

**Item Number: 3.943.02 - Plan: Blank Name Tags (80)**

**Item Number: 3.943.50 - Plan: Set Of 16 Unprinted Cards**

**Plan Plus**

Plan Plus was developed for children in the third year of primary school. It is an extension of Plan.

Contents:

- a wooden box (13 x 13 x 7.5 cm)
- 28 color-printed cards
- 4 plastic, blank cards
- 1 magnetic strip (roll)
- 80 blank cardboard name tags
- instructions

**Item Number: 3.947.00**



## Observing And Understanding



### Classificant I & Classificant II

The objective of Classificant is to teach children between the ages of 2 and 5 to learn to classify objects. This entails grouping objects in specific ways such as by color, shape and size. The objects are two and three-dimensional. Classificant consists of two boxes, one with large objects (Classificant I) and one with small objects (Classificant II). The objects in each box are identical, except for their size. There are four colored lids on each box that are also used as game boards. The opposite side of each lid is white.

When playing as a game, the box and lids serve as templates for the blocks. The children can build and sort the shapes into the boxes by fitting them through the openings on the lids (game boards). When used as a development tool, the children can classify the objects according to color, shape or size. The boxes and the lids provide a means of verification. By experimenting and exploring in this way, they will discover the system inherent in the materials.

Contents of Classificant I:

- 16 three-dimensional shapes (cubes, cylinders, three-sided prisms and four-sided prisms) in four colors
- 16 two-dimensional shapes (squares, circles, rectangles and triangles) in four colors

Contents of Classificant II:

This set contains the same shapes as Classificant I, but smaller in size.

Author: Dr. Jef J. van Kuyk

**Item Number: 3.936.00 - Classificant: I**

**Item Number: 3.935.00 - Classificant: II**

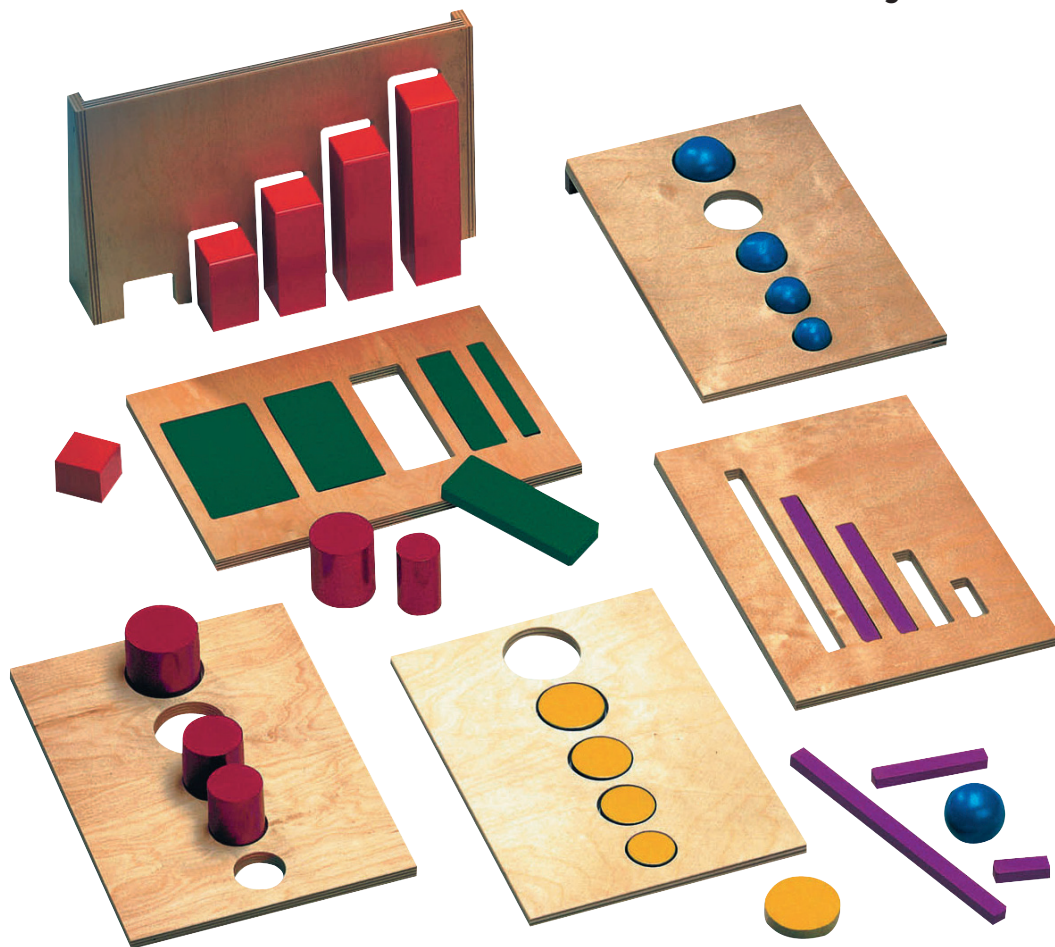

### **Serio**

Serio is designed to teach pre-school children between the ages of 2 and 4 how to put three-dimensional objects with features such as size, thickness, length, height and width into series. Serio can be played as a game where children are free to play as they wish. It is also used as a development tool when the teacher helps the children individually discover the system inherent in Serio. The latter is particularly important for children who have difficulty with self-discovery and taking initiative.

Contents - each sold separately:

- 6 wooden tablets (29.5 x 21 x 1cm) with cutouts for the objects below
- 30 three-dimensional objects:
  - 5 spheres, from large to small
  - 5 discs, from large to small
  - 5 cylinders, from thick to thin
  - 5 rods, from long to short
  - 5 prisms, from high to low
  - 5 prisms, from wide to narrow
- instructions
- a set of 6 exercise cards one side showing the completed flat surface of the objects and an outline representing the flat surface on the other. (available separately)
- presentation tray

Author: Dr. Jef J. van Kuyk

**Item Number: 3.940.01 - Serio: 5 Cylinders**

**Item Number: 3.940.02 - Serio: 5 Discs**

**Item Number: 3.940.03 - Serio: 5 Prisms From Wide To Narrow**

**Item Number: 3.940.04 - Serio: 5 Prisms From High To Low**

**Item Number: 3.940.05 - Serio: 5 Rods**

**Item Number: 3.940.06 - Serio: 5 Spheres**

**Item Number: 3.940.10 - Serio: Set Of 6 Exercise Cards**

**Item Number: 3.939.00 - Serio: Presentation Tray (1)**

## Observing And Understanding

### Seriant I & Seriant II

Seriant is designed to help children between the ages of 4 and 7 learn about the concept of size and how to classify objects based on one and two characteristics. These three areas of development are very important for learning practical skills and for performing activities at home and school.

Contents of Seriant I:

- a box with a lid (32 x 32 x 9 cm) with 4 series of objects increasing in length, thickness, height or width. Each series consists of 12 objects, of which the largest and smallest are duplicated
- instructions

Contents of Seriant II:

- a box with a lid (32 x 32 x 9 cm) with 4 series of objects increasing in length, thickness, height or width. Each series is divided into 2 series of 5 different colors and shades. The shades do not relate to the size of the object; color and size are classified independently
- instructions

Author: Dr. Jef J. van Kuyk

**Item Number: 3.920.00 - Seriant: I**

**Item Number: 3.921.00 - Seriant: II**

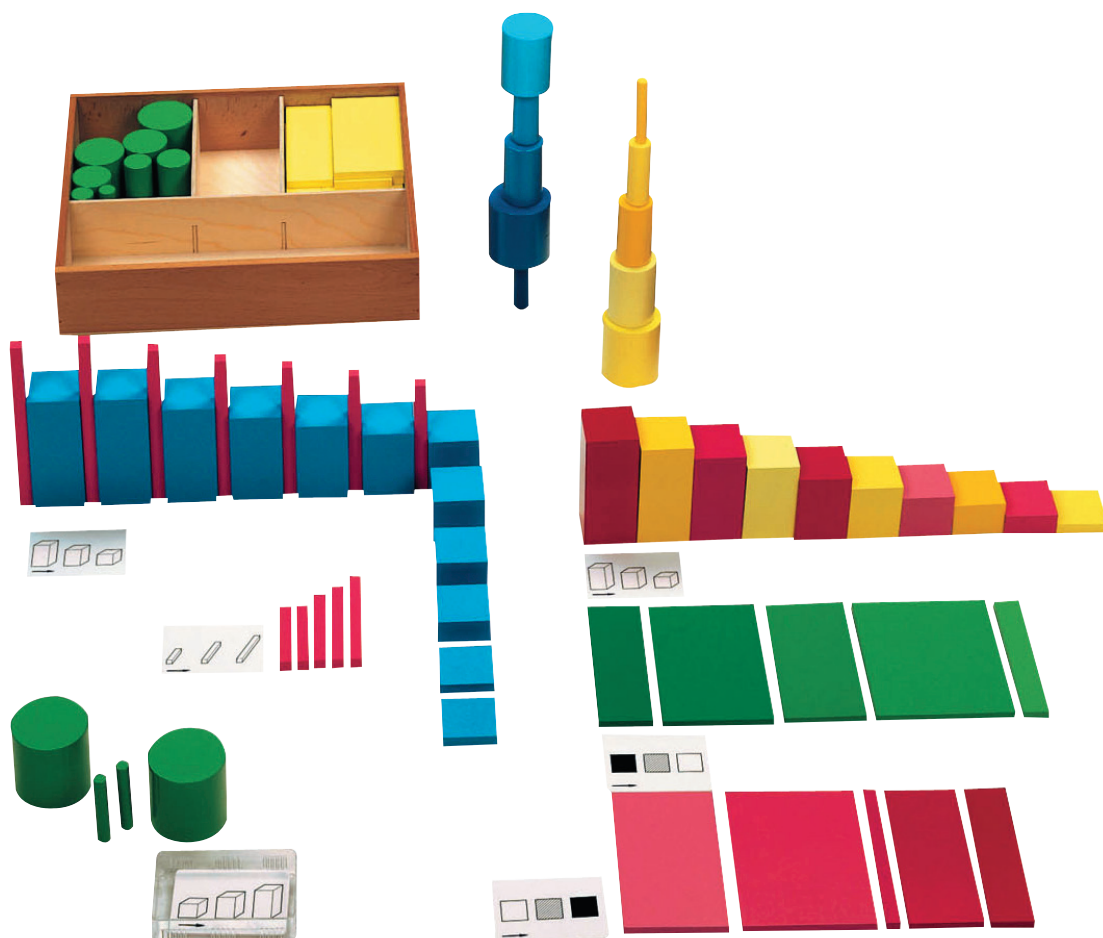

**Comparant**

Working with Comparant helps children learn the following: comparison of quantity (more, less), counting to 5 and 10, how to work with a matrix and performing simple addition and subtraction exercises.

Contents:

- a wooden box with a lid that serves as the matrix (32 x 32 x 9 cm)
- 20 chips – 10 red and 10 yellow
- 20 geese
- 20 houses
- 20 people
- 20 trees
- 5 cards with pictures
- 4 comparison strips
- 2 number strips
- 20 cards with dots: 1-10 structured and 102 unstructured
- 20 number cards: 2 sets of 1-10
- 4 '+' signs, 4 '-' signs, 3 '>' signs, 4 '=' signs
- 3 comparison cards, printed on both sides
- 10 exercise cards, printed on both sides
- instructions

Author: Dr. Jef J. van Kuyk

**Item Number: 3.390.00**



**Pyramid**

The wooden pyramid symbolizes 'The Pyramid Method' of teaching.

The pyramid contains four cornerstones and is constructed in three layers.

These cornerstones represent the child's initiative, the teachers' initiative, nearness (safety) and distance (exploration). Pyramid Presentation Tray sold separately.

Contents:

- a wooden pyramid, divided into 12 pieces, total height 21 cm

Author: Dr. Jef J. van Kuyk

**Pyramid: Beechwood**

**Item Number: 3.945.00**



**Pyramid: Presentation Tray**

**Item Number: 3.945.10**

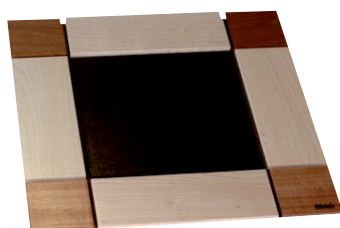

## Colors And Shapes

### Resemblance Color Sorting Task: 1

With using the Resemblance Color Sorting Task, children learn how to: grade and sort the three primary colors, recognize two forms: 3-dimensional and flat, exercise the motor skills (threading) and count.

Contents:

- a wooden box with lid (30 x 25 x 6 cm)
- 240 round and square beads in red, yellow and blue
- three strings
- a form die
- a color die
- 6 exercise cards with threading examples
- instructions

**Item Number: 3.203.00**

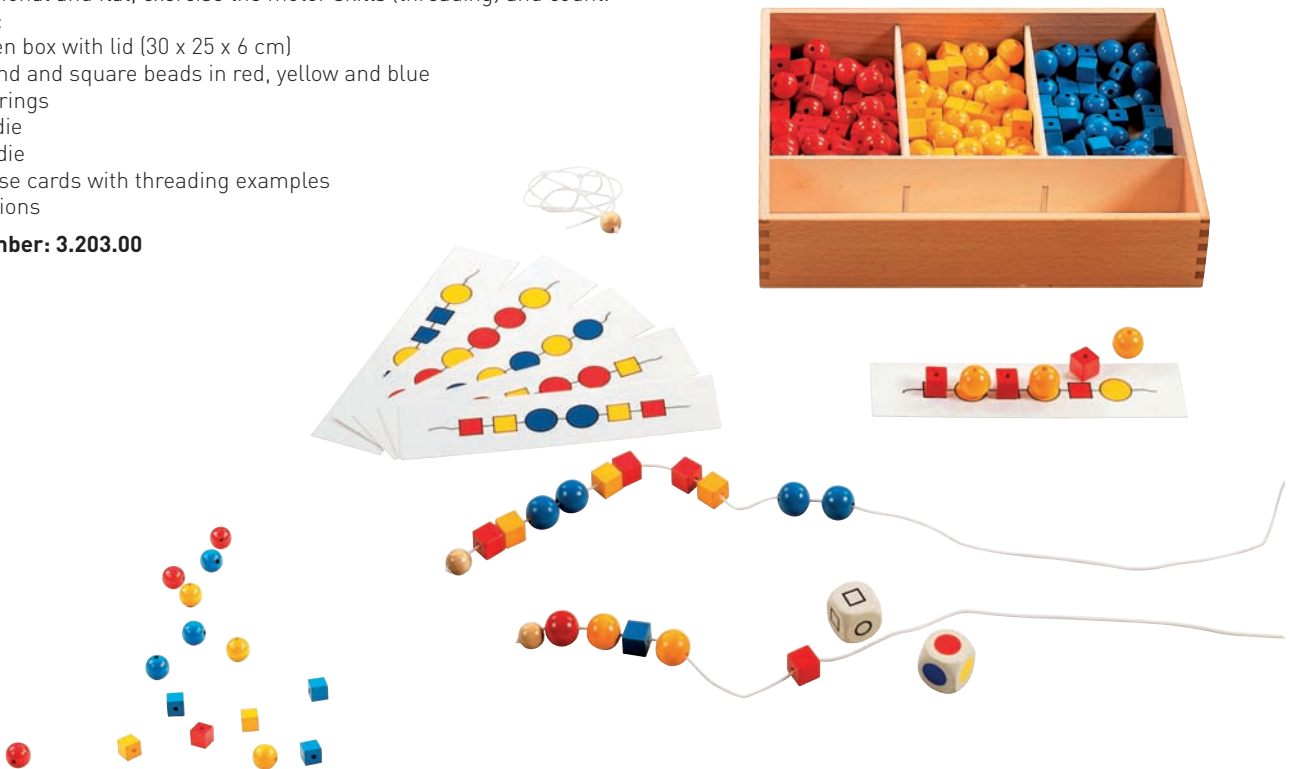

### Resemblance Color Sorting Task: 3

The Resemblance Color Sorting Task 3 is a matching and sorting game using shades of color to develop skills in visual perception and color discrimination. The color task provides an excellent opportunity to introduce vocabulary so that the child may learn the names for each of the colors and the associated descriptive terms.

Contents:

- a wooden box with lid (30 x 25 x 6 cm)
- 24 beechwood skittles painted in 4 graded shades of each of the colors red, yellow, blue, green, orange and purple
- 6 wooden stands to hold each set of skittles and 6 wooden color boards with each of the shades from dark to light to match with the skittles
- instructions

**Item Number: 3.202.00**





**Color Counting And Sorting Game**

This material provides an opportunity for a wide variety of games and activities which develop skills in color recognition, quantity and number and sorting abilities. The versatility of this product allows children to use it at many different levels and to invent their own games.

Contents:

- a wooden box with lid
- 72 painted wooden skittles 12 per color
- 4 dice: 3 and 6 colors, 1-3 and 1-6
- 6 wooden stands
- 6 colored wooden triangles
- 90 colored plastic chips in a box
- instructions

**Item Number: 3.205.00**



**Mozaiko**

By playing with Mozaiko, children practice their visual perception by 'reading' and then performing the exercises. The children analyze the observations logically, and convert them into delicate motor activities. They learn to discriminate by shape, color, position and direction.

Contents:

- a wooden box with lid (22.5 x 22.5 x 4 cm)
- 4 pattern cards with squares
- 4 coded exercise cards with arrows
- 4 activity boards
- 4 wooden markers
- 100 coded plastic mosaic pieces
- instructions

Author: L. Bos

**Item Number: 3.039.00**

## Colors And Shapes

### Blocolo

Through using two and three dimensional materials in a playful manner, the child becomes familiar with the various geometric shapes, cards and spatial concepts (behind, in front, left, right, etc).

Contents:

- a wooden box with lid (28 x 28 x 5 cm)
- 24 wooden blocks
- 4 color cards
- 46 assignment cards
- 14 assignment strips
- 1 cotton bag
- instructions

Author: L. Bos

Item Number 3.027.00



### Patero

In this game the illustrations look very much alike at first glance, however there are subtle differences. Learning to observe small differences in position and detail is a condition for learning to read, write and do mathematics. The material is self-checking.

Contents:

- one storage tray (31 x 16 x 2 cm)
- 4 game boards (14 x 14 cm)
- 32 printed wooden tablets (7 x 4 cm)
- instructions

Author: M. Junga

Item Number: 3.046.00





## Colors And Shapes



### Plus

With Plus, children exercise their powers of observation, their motor skills and spatial insights. By doing the assignments, children learn how composition shapes are put together, which shape comes first and which one belongs on top of it. The assignments take the form of 'sums'. What do they get when they add one shape to another? The result is a composition shape. When playing the communication game, children train their auditory memory by describing the shapes through spoken assignments.

#### Contents:

- a wooden box with lid ( 35.5 x 16.5 x 5 cm)
- 2 activity boards with supports, to be used on both sides
- 7 pegs for the activity boards
- 16 self-correcting assignment cards (4 series)
- 28 wooden figures (2 sets of 14 figures)
- instructions

**Item Number: 3.053.00**

### Koloranto

Playing with Koloranto helps develop shape and color perception. The children learn how to make a whole out of two parts.

#### Contents:

- a wooden box with lid (17 x 12 x 3 cm)
- 9 illustrated strips
- 36 cards with 2 colors
- 18 cards with 1 color
- 18 transparent cards
- instructions

Author: L. Bos

**Item Number: 3.022.00**





## Colors And Shapes

### Tricolino

Tricolino is a game for improving concentration and acquiring a feeling for positions and colors and combinations. It teaches children to shape smaller elements into a whole.

Contents:

- a wooden box with lid (24 x 20 x 2.3 cm)
- 40 triangular pieces (5 x 5 x 5 cm)
- 2 blank spare pieces
- 6 pattern cards printed on both sides
- instructions

Author: C. Kranen

Item Number: 3.008.00



### Careta

Careta teaches children to distinguish and identify colors. This game, for 1-6 children, also teaches them to recognize and sort items according to two characteristics: facial expression and color. And when playing bingo in a group, they practice their social skills.

Contents:

- a wooden box with lid (14 x 14 x 3.5 cm)
- 40 plastic cards (4 x 4 cm)
- 1 double die
- 6 bingo cards (11.5 x 11.5 cm)
- 1 box with counters
- instructions

Item Number: 3.010.00

**Details**

Details is a game where children are taught about observing position, shape and color on pattern cards. They also learn the concept "parts of a whole". This material is an indirect preparation for reading, and is self-checking.

Contents:

- a wooden box with 4 compartments and lid (27 x 20 x 3 cm)
- 4 working cards (23 x 17.5 cm)
- 48 assignment cards (6 x 6 cm)
- 12 black frames used to isolate the "details" (6 x 6 cm)
- instructions

**Item Number: 3.071.00**



**Borboleta**

Borboleta is a fun game that requires children to concentrate and carefully observe differences or similarities. Children have to look for small details, find mirror images and even find the separate details that match a complete image. The games are geared towards color and shape-recognition. When playing together the children practice their social skills. The material is self-checking.

Contents:

- a wooden box with lid (32.5 x 25.5 x 3.5 cm)
- 6 plastic assignment cards
- 24 wooden colored discs
- 2 dice
- 2 wooden game boards (27.5 x 19.5 cm)
- 2 markers
- instructions

**Item Number: 3.091.00**



## Colors And Shapes

### Perlino

Young children will enjoy playing with Perlino, the colorful snake. They will learn to master skills such as: counting, controlled motor dexterity, how to distinguish and identify color, how to grade and combine the 3 primary colors, and how to work with and follow directions on the exercise cards.

Contents:

- a cotton bag (10 x 45 cm)
- a snake (6 x 40 cm)
- 6 exercise cards with threading examples (23 x 3.5 cm)
- 30 beads: 10 red, 10 yellow and 10 blue
- a color die
- instructions

Item Number: 3.026.00



### Tabaletto

With Tabaletto, the child's perceptual awareness is exercised on levels such as: awareness of quantities, colors, shapes and details of a whole. These are important exercises for visual discrimination. Doing the various exercises properly requires and stimulates the use of conceptual and imaginative thinking; it also stimulates language development. The material is self-checking.

Contents of each:

- a wooden game board with frame cover
- 24 printed tablets with control code
- instructions

Author: M. Junga

#### Tabaletto: Counting 1 -10

Item Number: 3.042.00



#### Tabaletto: Animals

Item Number: 3.044.00



#### Tabaletto: Shapes

Item Number: 3.043.00







**Team Building**

Build an elven city together! Team Building encourages children to cooperate as they build. It provides an opportunity to practice spatial perception and the perception of color and shape. Children build the six elven houses on the bases and join up the bases to create an elven city. When two children are playing, each child has blocks of one color and together they build an elven house following the instruction card. They may place only blocks of their own color. When four children are playing, each child has blocks of one shape. They may add only blocks of their own shape. This makes cooperation indispensable.

Contents:

- a wooden box with lid (35 x 18 x 5 cm)
- 96 wooden blocks in 4 shapes and 2 colors
- 18 instruction cards at 3 levels
- 6 bases
- instructions

Author: Meeple

**Item Number: 3.003.00**

**Componere**

With Componere Flori, color and size are key elements. Componere Dotti is further advanced as the children are asked to distinguish 3 sizes instead of 2. The game helps exercise the powers of concentration, analytical thinking and social skills. The material is self-checking.

Contents of each:

- a wooden game board (31 x 28 cm)
- 25 wooden tablets
- instructions

Author: K. Fassbender

**Componere: Flori**

**Item Number: 3.024.00**



**Componere: Dotti**

**Item Number: 3.023.00**

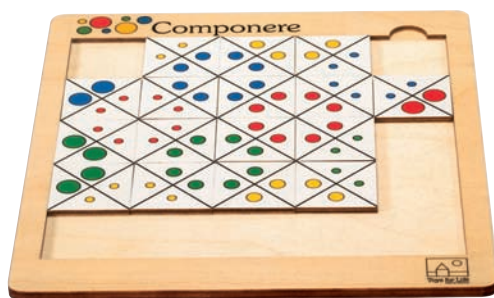

## Colors And Shapes

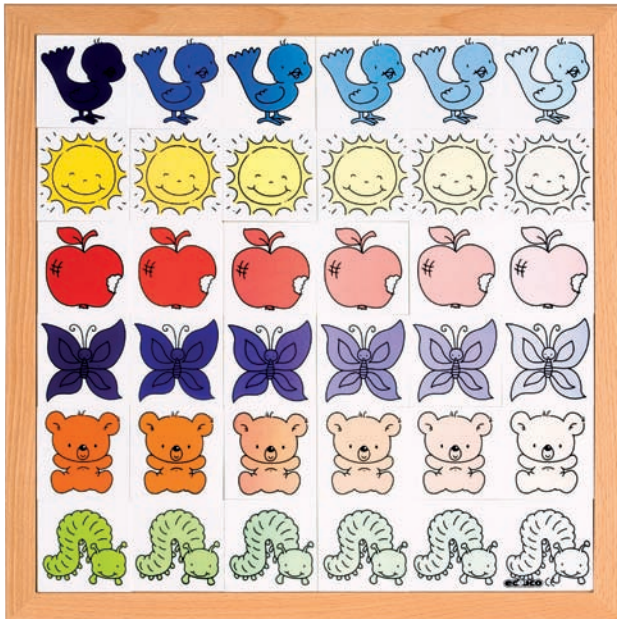

### Color Nuance Game

This game encourages a child to differentiate between grades of a particular color. A beech wood frame holds 36 plastic image cards. Frame size: 40 x 40 cm.

**Item Number: 522.227**

### Rings And Sticks Game

This game actively encourages the development of the child's imagination. There are 248 colored plastic shapes and 24 model cards. The child is encouraged to work progressively by first copying the colored outlined shapes, then the monochrome outlines, then to create their own designs. Includes a box with lid (35 x 19 x 8 cm) and instructions.

**Item Number: 522.172**



**Design Board**

This attractive material is used to develop perception of shape, colors, numbers and fine motor skills. The child uses the 'three finger grip' to hold the beads while positioning them on the nail board, which is an indirect preparation for writing. (Pattern Cards and Beads sold separately).

Contents of each Design Board:

- wooden nail board with a square or round pattern. This is used as the lid for the box.
- wooden box (21 x 21 x 4 cm)

**Item Number: 095.026 – Design Board: Square**

**Item Number: 095.026 – Design Board: Round**

**Item Number: 3.412.20 – Design Board: Pattern Cards – Square (12)**

**Item Number: 3.412.50 – Design Board: Pattern Cards – Round (12)**

**Item Number: 036.094 – Design Board/Kralo: Beads (1000)**



**Kralo**

A variety of different sets, all consisting of a plastic base board, 12 pattern cards, and 500 plastic beads. Packed in a wooden box (22 x 22 x 5.5 cm).

**Item Number: 522.801 - Kralo: Set 1**

**Item Number: 522.802 - Kralo: Set 2**

**Item Number: 522.803 - Kralo: Set 3**

**Item Number: 522.804 - Kralo: Set 4**

**Item Number: 036.094 - Design Board/Kralo: Extra Beads (1000)**

## Colors And Shapes

### Colodie Puzzle Game

A wonderful game for 3-4 year olds, Colodie features 6 classically shaped animal jigsaws. Each puzzle has 6 pieces, each in a different color. By using the 2 colored dice (included), completing the jigsaws can be turned into a party game - throw the dice, find the right piece - the first child to complete their jigsaw is the winner.

Includes a wooden box with lid (23 x 20 x 8) and instructions.  
Puzzle size: 18 x 18 cm

**Item Number: 522.040**



### Geo Forms Play

A plastic board with 9 different geometric shapes in 6 colors.  
Size: 25 x 25 cm.

**Item Number: 522.847**

### Figurondo

Create the figures that are indicated on the different pattern cards by using the colored chips.

Contents:

- a partitioned wooden box with lid (31.5 x 22.5 x 7 cm)
- 12 pattern cards: 6 with simple abstract images, 4 with concrete images, 2 blank
- colored chips

**Item Number: 522.936**



### Find The Shape

A beautiful set of games for shape recognition. There are three levels of difficulty. In level 1, the child has to discover the shape that is hidden in the picture. In level 2, the child has to discover the letters that are hidden in the pictures. In level 3, the child has to discover what fits together to create a whole. When the exercises are completed, the cards are turned over to see the control on the back of the cards. If all was completed correctly, a new shape is shown.

Contents:

- a wooden box with lid (34 x 20 x 6 cm)
- 9 assignment cards
- 36 matching cards
- instructions

**Item Number: 522.909**



### Tangrams

Tangrams contains 7 different double-sided plastic shapes (6 of each shape are provided) which are used in conjunction with 24 plastic assignment cards. Half the cards show a full shape pattern, the others, just the outline. The children can also create their own patterns and designs. Includes a partitioned wooden box with lid (35 x 19 x 8 cm) and instructions.

**Item Number: 522.023**

## Colors And Shapes

### Happy Hammer: Geo

A revised version of the original favorite. Children create figures from the pattern cards or of their own on the cork board with the shapes, the hammer, and nails. (additional nails, shapes, cork boards, hammers, and nails available separately).

Contents:

- a partitioned wooden box with lid (40 x 34 x 8 cm)
- 2 cork boards (30 x 22.5 cm)
- 2 small hammers
- 12 pattern cards
- 144 plastic shapes
- 1 box of nails

**Item Number: 522.355**

Available Separately:

**Item Number: 522.357 – Happy Hammer: Set Of Plastic Shapes**

**Item Number: 512.091 – Happy Hammer: Cork Board With Pattern Cards**

**Item Number: 512.092 – Happy Hammer: Cork Board Only (1)**

**Item Number: 512.090 – Happy Hammer: Box Of Nails**

**Item Number: 522.380 – Happy Hammer: Small Hammer**



### Happy Hammer: Farm

Whether the children follow the 12 pattern cards, or make up their own scenes, this is a great activity featuring farmyard figures. (additional nails, farmyard figures, cork boards, hammers and nails available separately).

Contents:

- a partitioned wooden box with lid (40 x 34 x 8 cm)
- 2 cork boards (30 x 22.5 cm)
- 2 small hammers
- 12 pattern cards
- 72 plastic farmyard figures
- 1 box of nails

**Item Number: 522.353**

Available Separately:

**Item Number: 522.805 – Happy Hammer: Set Of Plastic Farmyard Figures**

**Item Number: 512.091 – Happy Hammer: Cork Board With Pattern Cards**

**Item Number: 512.092 – Happy Hammer: Cork Board Only (1)**

**Item Number: 512.090 – Happy Hammer: Box Of Nails**

**Item Number: 522.380 – Happy Hammer: Small Hammer**



**Figurogram**

This is a fascinating set that promotes the developmental understanding of shape, color, form and pattern. In addition to following the pattern cards, the children can also create their own limitless patterns and designs.

Contents:

- a partitioned wooden box with lid (35 x 19 x 8 cm)
- 48 plastic shapes
- 18 pattern cards
- 1 plastic safety mirror
- instructions

**Item Number: 522.231**



**Building Spatial**

This game explores the spatial relationship between 2-D and 3-D shapes and designs. The children use wooden blocks to try to re-create the images on the pattern cards. Using the plastic mirror is added later to add difficulty to the exercises.

Contents:

- a partitioned wooden box with lid (35 x 19 x 8 cm)
- 24 pattern cards
- 40 wooden blocks
- 1 plastic safety mirror

**Item Number: 522.234**

## Colors And Shapes

### Insert Mosaic: 15 mm

Is a developmental game that hones motor skills as well as color and pattern perception. The pins are a mix of round and square shapes in 6 colors, and are made of virtually unbreakable plastic. The insert frames are made of flexible plastic.

Contents:

- a wooden box with lid (40 x 34 x 9 cm)
- 2 insert frames
- 10 pattern cards
- 400 plastic pins – round and square
- instructions

**Item Number: 522.334**

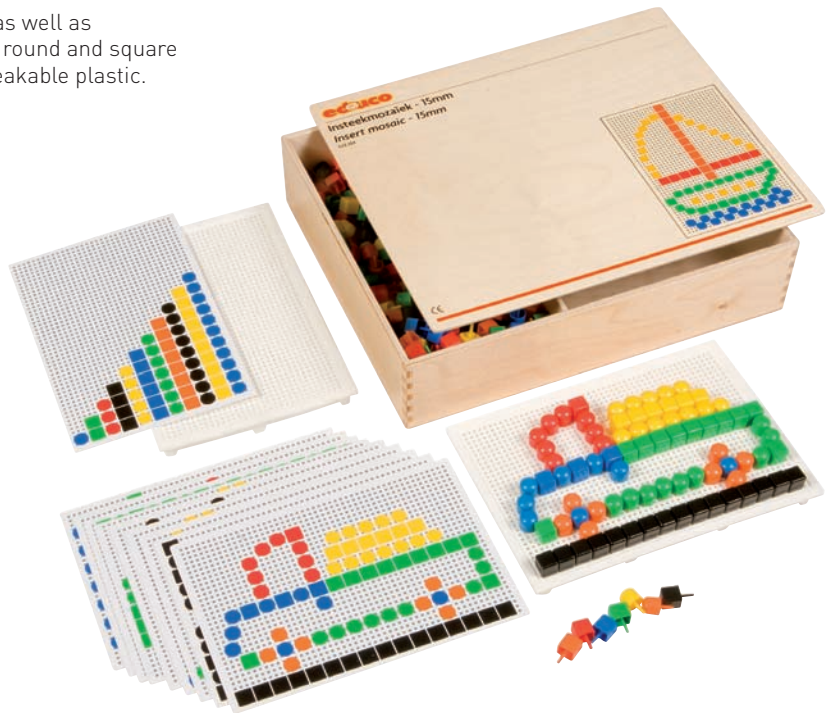

### Jumbo Insert Mosaic

A transparent insert mosaic frame game, that encourages children to exercise their color and shape perception. Children will love to make their own creations, but can also use the included pattern cards if they wish. The cards have 8 levels of difficulty. (Frame sold separately).

Contents:

- a wooden box with lid (31 x 29 x 8.5 cm)
- 8 pattern cards
- 160 colored pegs

**Item Number: 523.096 – Jumbo Insert Mosaic**

**Item Number: 523.095 – Jumbo Insert Mosaic: Frame**





**Fröbel Magnetic Mosaic Set**

Children develop their color and shape perception abilities by playing with the Fröbel Mosaic set. The designs will neatly stick to the assignment cards because of the magnetic materials. The assignments cards increase in difficulty.

Contents:

- a plastic box with lid (23 x 17.5 x 4.5 cm)
- 9 assignment cards – magnetic and printed on both sides
- 1 blank card – magnetic
- mosaic shapes – colored on both sides

**Item Number: 523.141**



**Figuroform**

How many different ways can you form a circle? Figuroform offers virtually endless ways of looking at a simple form and how it is constructed. It is also a simple way to introduce children to the concept of fractions (1/4, 1/2, etc.) and geometric shapes (semi-circle, oval, etc.).

Contents:

- a wooden box (35 x 35 x 8 cm)
- 3 plastic working boards
- 12 assignment cards
- plastic shapes in 6 colors

**Item Number: 522.949**



## Language

### Vidico

Vidico is a multifunctional material that can be used with many language methods. A list of words is created on the exercise card and is inserted into the wooden cassette. One by one the child removes the cover and either spells the word out-loud, or writes the word onto the working chart. The concept is to isolate each word so the child, as he learns, is not distracted and is able to focus on one word at a time. Use of Vidico, has proven to be very helpful for children that have difficulty spelling and is excellent for teaching vocabulary and foreign languages. The possibilities are endless. This material is self-correcting.

Contents:

- a wooden cassette
- 1 blank plastic working chart for copying
- 11 plastic exercise cards for copying
- instructions

Author: S. de Vries

Item Number: 0.815.00



**Rubber Stamp Set: Alphabet Letters - Outline**

Item Number: 042.066

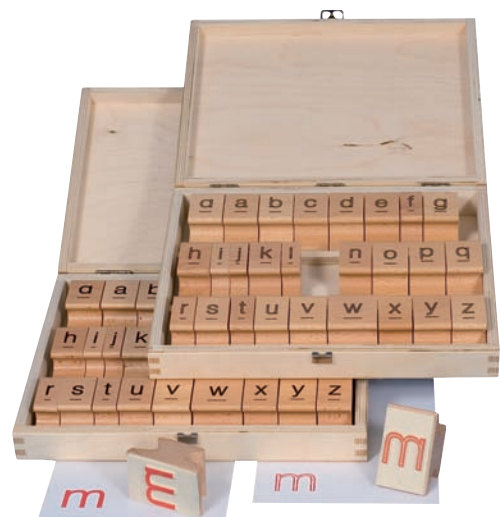

**Rubber Stamp Set: Alphabet Letters - Solid**

Item Number: 042.452



**Farfalla**

Farfalla is designed to stimulate children to work with, and understand numbers. In addition to learning to recognize and name numbers, they also learn their numeric values. Because there are various levels to the game, older children can take it a step further, and create equations and their sums.

Contents:

- a wooden box with lid (30.8 x 30.8 x 3.5 cm)
- 1 game board in 4 parts (50 x 50 cm) each
- 24 butterfly cards
- 2 each of 12 cards with dots
- 2 each of 12 cards with numbers
- 2 (+) symbol cards
- 2 (-) symbols cards
- 1 die
- instructions

Author: G. Otter

**Item Number: 3.073.00**

**Contini**

While playing with Contini, children will have fun learning the concept of the quantities of 1 through 6. They will learn the relationship between the quantities, their symbols and their values. The children also learn to calculate quantities at a glance and do simple addition problems up to six.

Contents:

- a wooden box with lid (24 x 24 x 4 cm)
- 8 lotto boards – 4 with apples, 4 with numbers
- 2 spinners – 1 with apples, 1 with numbers
- 72 cards: 4 each of 6 with apples, images and numbers
- instructions

**Item Number: 3.078.00**



## Mathematics

### Calculino

Calculino is an entertaining game with early addition and subtraction activities for primary school children. The children can work on their own, as the material is self-checking, or in pairs. When working together, one child reads out the exercise and the other child puts the puzzle piece with the correct answer on the table. When the exercise is finished, the children can see if they did the exercise correctly, by checking the control card.

Contents:

- a wooden box with lid (25.6 x 17.6 x 2.9 cm)
- 12 wooden puzzle pieces with numbers
- 20 exercise cards (control on the back)
- instructions

**Item Number: 3.030.00**



### Numerix

When using Numerix, children practice different notions of quantity, counting to ten, connecting a symbol (the figure) to a quantity and extending their vocabulary. The material is self-checking.

Contents:

- a wooden box with lid (20 x 20 x 3 cm)
- 4 theme cards
- 40 small cards, printed on both sides
- 40 plastic tokens
- instructions

Author: L. Bos

**Item Number: 3.021.00**



**Dotsy**

With Dotsy the ladybug, children learn the number combinations from 1 to 10. There are a different number of dots on each of the "wings" - 5 is the largest number represented. Children create a ladybug by splitting the numbers 1 to 10 through the use of the "wings". Dotsy, indirectly prepares children for the addition of numbers through 10.

Contents:

- a wooden box with lid (26.2 x 18.6 x 4.1 cm)
- 2 activity boards in the shape of leaves, with recesses for the number cards in the wings
- 62 wings
- 2 answer cards
- 48 round assignment cards (two times 10 number cards, 1 to 10 and 28 arithmetic assignments from 1 to 10)
- instructions

Author: Jitske de Jong

**Item Number: 3.072.00**

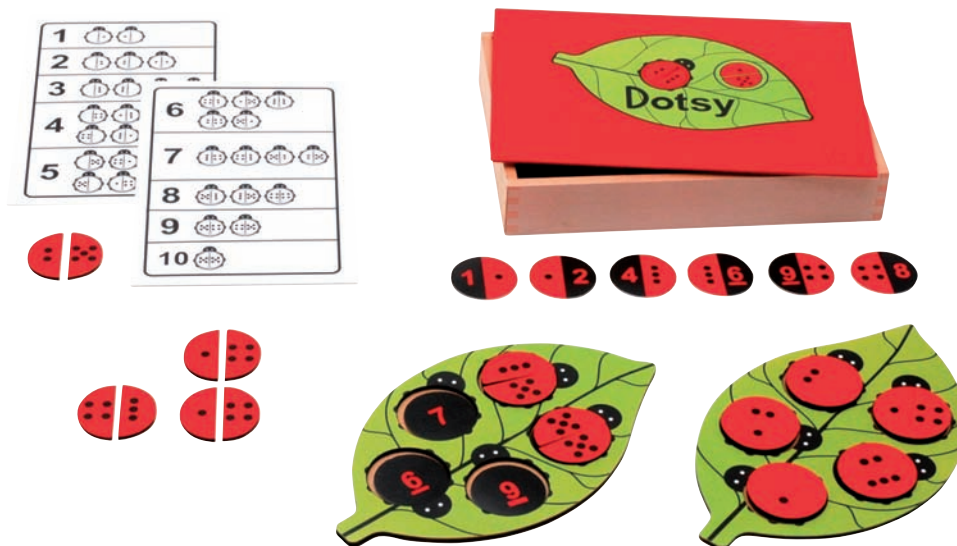

**Quantity Splitting Box**

Classroom observation has shown that it is difficult for children to master the addition and subtraction combinations of numbers. The Quantity Splitting Box helps to make this essential element of arithmetic, a pleasant and rewarding experience. Children will find this game a fun and interesting way to practice and memorize simple arithmetic combinations.

Contents:

- two stacking wooden boxes. The upper box has a sliding panel and a sloping bottom panel with a hole in the center. The lower box is divided into two compartments with a solid bottom panel. In addition, two pieces of felt, one green and one red, fit into the compartments of the lower box.
- 20 marbles
- instructions

Authors: A. Postma and J. v. d. Ploeg

**Item Number: 3.200.00**



## Mathematics

### Color And Counting Lotto

This material is designed to develop a variety of skills, including color matching and number recognition. Using the Color And Counting Lotto, the children practice recognizing numbers by counting the quantities and then associating the proper numeral with them. The lotto is also used to perform simple sums using the + and = signs. The Color And Counting Lotto provides opportunities for language enrichment by teaching the names for each of the numbers as well as associated mathematical terms.

Contents:

- a wooden box with lid
- 10 pairs of colorful wooden tablets
- 60 wooden tablets with numerals, signs, and dots printed on them
- instructions

**Item Number: 3.228.00**



### Counting Lotto

While playing with the Counting lotto children develop skills in counting as well as providing practice in associating number quantities and numerals from 0 to 9. The versatility of the Counting Lotto allows the child to progress in a series of activities from simple counting of colorful objects, to abstract recognition of numbers. This material is well suited for young children.

Contents:

- a wooden box with lid (38 x 20 x 5.5 cm)
- 4 wooden boards with four rows of pictures on each, showing items to be counted, from 0 to 9
- 1 set of printed numerals on wooden squares from 0 to 9
- 1 set of wooden squares with dots for the quantities 0 to 9
- instructions

**Item Number: 3.230.00**



**Quanty**

When playing with Quanty, children become familiar with: the concept of quantities from 1-5, the comparison of quantities, the combination quantity symbol, they learn to recognize quantities at a glance (universal quantity perception) and how to work with a matrix grid.

Contents:

- a wooden box with lid (31 x 31 x 5 cm), lid also serves as matrix field
- a series of wooden fruits and vegetables
- 40 boards with pictures of fruits and vegetables, hands, colors and figures
- a pentagon for the placing of the boards
- two spinners
- 10 exercise cards
- instructions

Author: Swientjes

**Item Number: 3.260.00**



**Serpa**

When working with Serpa, the children experiment with: counting from 1 – 10, the sequencing of numbers, the concept of 'more than and less than', recognizing quantities at a glance, and a combination of quantity symbols.

Contents:

- a wooden box with lid (24 x 24 x 3.5 cm)
- 45 plastic cards consisting of:
  - 12 'snake' cards
  - 10 'objects' cards
  - 10 'symbols' cards
  - 10 'dots' cards
  - 3 control cards
- instructions

Author and illustrator: A. Sommerfeld

**Item Number: 3.070.00**



## Mathematics



### Apple Tree Game

When playing with this material, children develop concepts in quantity recognition, more-than and less-than relationships, simple combinations of numbers, as well as fundamentals of addition and subtraction. The game has different levels of complexity, making it possible for the children to develop skills in a series of steps. The Apple Tree Game can be played by two or more players.

Contents:

- a wooden tray (39 x 27 x 2 cm), the tray has two compartments
- 60 wooden pegs, representing the apples
- 2 dice
- instructions

**Item Number: 3.223.00**

### Apple Tree Counting Set

There is no a better way to develop number recognition and demonstrate addition combinations than with the Apple Tree Counting Set. Each of the numbers 1 to 10 is represented by both dots and numerals printed on the wooden pieces with the apple tree.

Contents:

- a wooden box (15 x 14 x 5 cm)
- 10 wooden boards (12 x 9.5 cm), with an apple tree printed on each board. Each apple tree has 10 holes. Each board has dots and symbols for one of the numbers 1 to 10 printed in the corner
- 60 green and 60 red wooden pegs representing apples
- instructions

**Item Number: 3.429.00 - Apple Tree Counting Set**

**Item Number: 3.432.00 - Extra Apples: Green (60)**

**Item Number: 3.433.00 - Extra Apples: Red (60)**





**Dubio Junior**

Dubio Junior is designed to enable young children to exercise their various skills independently. This self-checking material enables the child to discover whether he or she has performed an assignment correctly.

Contents:

There are multiple sets of assignment cards, designed for young children. Each set consists of 20 assignment cards, except for the ABC, which comprises 26 assignment cards. All sets are supplied in a plastic box.

**Item Number: 3.089.00 - Dubio Junior: Activity Box**

**Item Number: 3.090.10 - Dubio Junior: abc Lowercase Letters**

**Item Number: 3.090.DE - Dubio Junior: ABC Uppercase Letters**

**Item Number: 3.090.20 - Dubio Junior: Counting To 10**

**Item Number: 3.090.30 - Dubio Junior: Addition To 10**

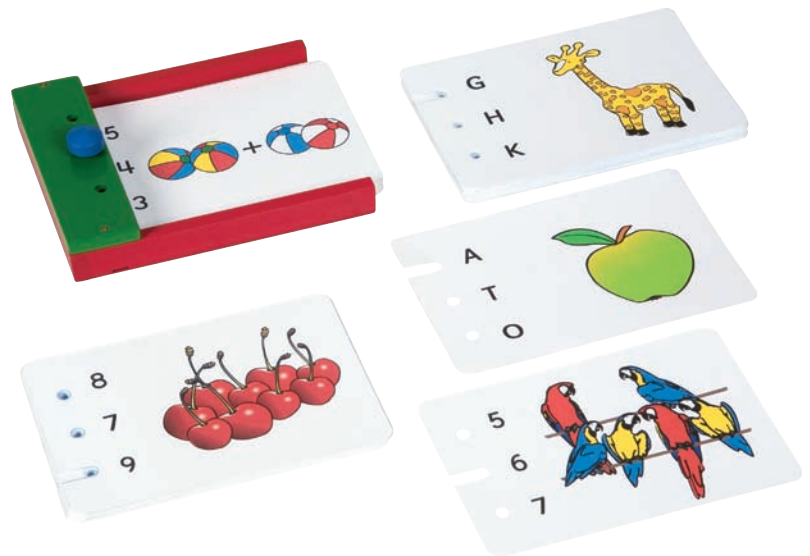

**Math Bus**

The Math Bus is designed to help young children improve their number skills (0 - 10). Working with the Math Bus provides a fun way to develop mathematical awareness, including counting skills, number value, simple addition and subtraction and number equations. (Math Bus Stand and exercise cards sold separately).

Contents:

- 1 bus (44 x 24 x 2 cm)
- 10 passengers
- instructions

Authors: E. v. d. Kamp and E. v. d. Moolen-Kelholt

**Item Number: 3.018.00 - Math Bus**

**Item Number: 3.018.A0 - Math Bus: Stand**

**Item Number: 3.018.B0 - Math Bus: Exercise Cards**



## Mathematics

### Flip Flop

Flip Flop offers many possibilities, such as working with arithmetic assignments, language assignments, etc. Flip Flop can be played individually or with a group of children. When a group of children play with this material, they can consult about the correct answers and then check the answers together. Flip Flop is self-checking.

©: Brio Lek & Lär and Nienhuis

**Item Number: 3.110.00 - Flip Flop: Box**

**Item Number: 3.111.00 - Flip Flop: Control Cards**

**Item Number: 3.112.00 - Flip Flop: Counting 1 - 10**

**Item Number: 3.113.00 - Flip Flop: Addition 1 - 10**

**Item Number: 3.114.00 - Flip Flop: Addition 10 - 20 a**

**Item Number: 3.115.00 - Flip Flop: Addition 10 - 20 b**

**Item Number: 3.116.00 - Flip Flop: Subtraction 1 - 10**

**Item Number: 3.117.00 - Flip Flop: Subtraction 10 - 20 a**

**Item Number: 3.118.00 - Flip Flop: Subtraction 10 - 20 b**

**Item Number: 3.119.00 - Flip Flop: Multiplication Tables 1 and 2**

**Item Number: 3.120.00 - Flip Flop: Multiplication Tables 3 and 4**

**Item Number: 3.121.00 - Flip Flop: Multiplication Tables 5 and 6**

**Item Number: 3.122.00 - Flip Flop: Multiplication Tables 7 and 8**

**Item Number: 3.123.00 - Flip Flop: Multiplication Tables 9 and 10**

**Item Number: 3.124.00 - Flip Flop: My First Words - In And Around The House**

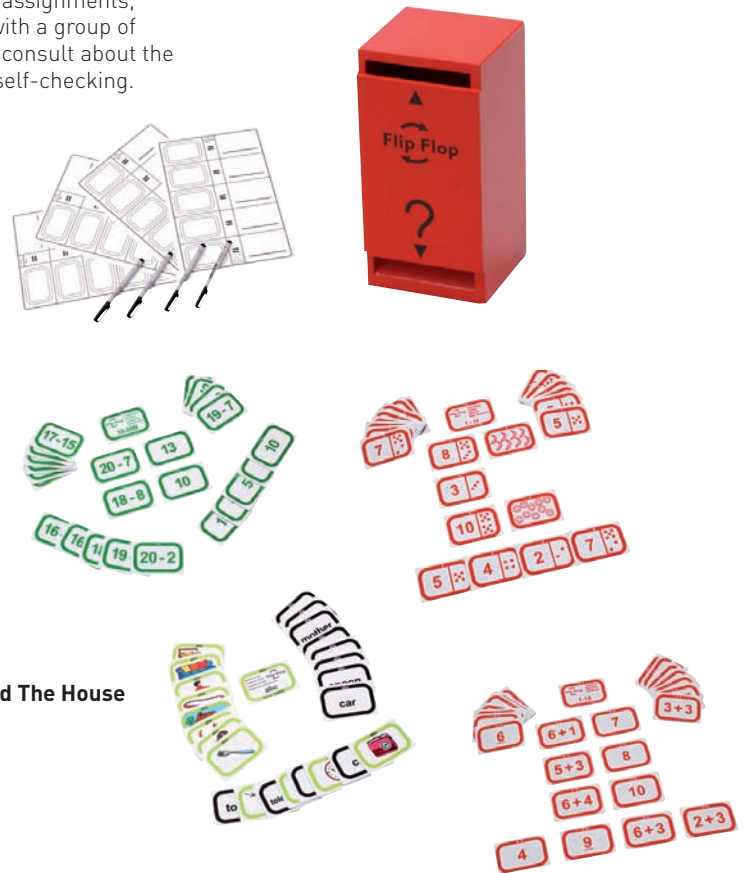

### Bus 20

Bus 20 is designed to help young children to achieve improved number skills (0 - 20). Working with Bus 20 provides a fun way to develop mathematical awareness, such as counting skills, number value, and simple addition and subtraction. Bus 20 is an extension of the Math Bus. With the Math Bus, exercises went through 10; with Bus 20, addition and subtraction go through 20. (Math Bus Stand sold separately).

Contents:

- 1 double-decker bus (50 x 25 cm)
- 20 passengers (7 x 3 cm)
- 7 exercise cards (20 x 14.5 cm)
- instructions

**Item Number: 3.076.00 - Bus 20**

**Item Number: 3.076.10 - Bus 20: Stand**



**Dubio**

Children gain their initial understanding of mathematic concepts and skills from real-life situations. As the learning process takes place, it is important that the child be able to check their work to get immediate satisfaction. With Dubio, children work the problems, discover solutions on their own and learn to recognize 'connections' where they may exist. The various sets of Dubio progress from simple to more complex mathematical calculations. Dubio is self-correcting.

Contents:

- a wooden box with four holes and a wooden peg (12 x 10 x 3 cm)
- instructions.

**Item Number: 3.450.00**

**Dubio Exercise Cards**

The following sets of 20 cards with 40 exercises, are available separately.

**Item Number: 3.451.10 - Dubio: Classifying Numbers 1 - 12**

**Item Number: 3.451.20 - Dubio: Classifying Numbers 11 - 20**

**Item Number: 3.451.30 - Dubio: The Number - Images**

**Item Number: 3.451.40 - Dubio: Dividing**

**Item Number: 3.451.50 - Dubio: Calculating To 10**

**Item Number: 3.451.60 - Dubio: Calculating To 20**

**Item Number: 3.451.70 - Dubio: Tens And Units**

**Item Number: 3.451.80 - Dubio: Hundred - Field**

**Item Number: 3.452.10 - Dubio: Calculating To 100 - Set A**

**Item Number: 3.452.20 - Dubio: Calculating To 100 - Set B**

**Item Number: 3.452.30 - Dubio: Multiplication - Set A**

**Item Number: 3.452.40 - Dubio: Multiplication - Set B**

**Item Number: 3.452.50 - Dubio: Division**

**Item Number: 3.452.60 - Dubio: Time**

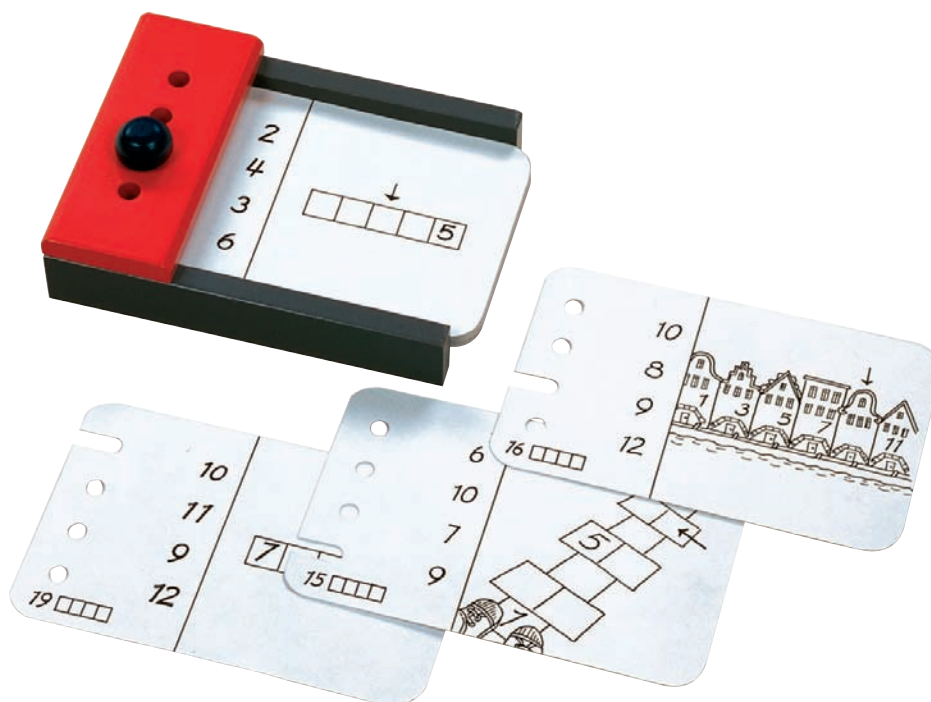

## Mathematics

99

99 is a fun, social game for 2 to 4 players. The object is to apply 'quick answers' to mathematical problems. It may be played at different levels: from simple addition, to more sophisticated operations involving addition, subtraction, multiplication or division.

Contents:

- the box is divided into 4 compartments with differing colors.

The top of the box is the game board and has a green knob.  
[31 x 31.5 cm].

- 6 dice

- 1 with signs + - x ÷

- 3 with the numbers 0 - 5

- 2 with the numbers 5 - 10

- 8 marbles in four different colors

- instructions

Author: F.J. Govaert

**Item Number: 3.865.00**

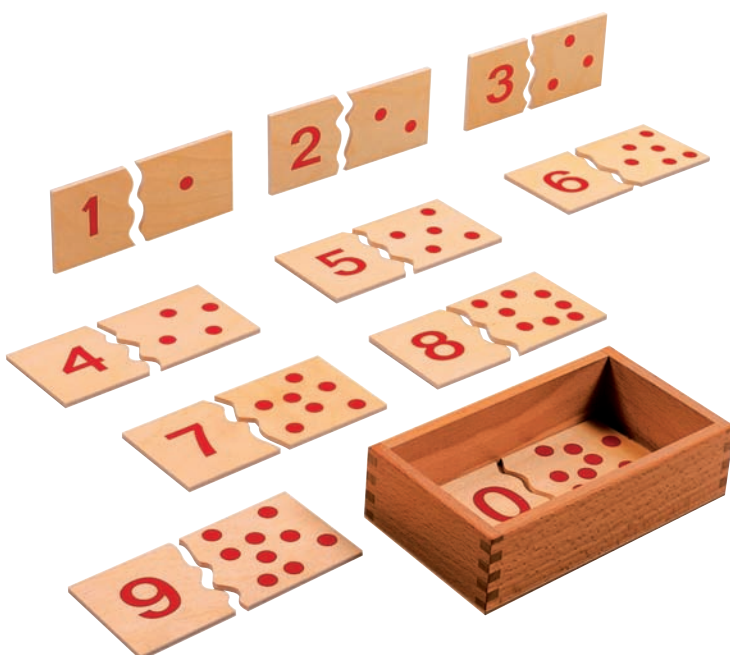

### Number Puzzle 1-10

This puzzle serves as an introduction to quantity and symbol relationship.

Contents:

- a wooden box with lid (16 x 9 x 5 cm)

- 20 wooden tablets that fit together when correctly matched

**Item Number: 3.530.00**



**Counting Circle Puzzle**

A jigsaw board puzzle that helps to reinforce an understanding of the numbers 1 to 10. This is achieved by placing the correct "cake wedge" into the circle. Each section of the cake wedge has a picture that matches the number. For example: the number 7 has a picture of 7 little fish and one of 7 dots belonging to it and the 3 blocks are placed into a wedge. Frame size: 33.5 x 33.5 cm.

**Item Number: 522.053**

**Numbers Puzzle**

Geared towards the comprehension of quantities, this game has 10 jigsaws featuring a number from 1-10. The number of the jigsaw denotes how many pieces that jigsaw has. The jigsaw pieces are made of wood. Includes a wooden box with lid (35 x 20 x 6 cm)

**Item Number: 522.094**



**Tello**

Tello teaches children how to make equal quantities of different objects. The game has 5 plastic number boards, each concentrating on two different numbers, that cover the numbers 1-10. The child picks out various objects relating to one of the numbers. Tello can be played individually or by a group of children.

Contents:

- a partitioned wooden box with lid (41 x 20 x 6 cm).
- 5 plastic number boards
- 30 plastic number/symbol cards (38 x 14 cm).
- 55 plastic cap inserts
- 55 tiddlywinks and 55 pawns
- instructions

**Item Number: 522.496**

Mathematics

Numbers And Counting



**Five In A Row**

This is a box set of 8 different matching games. Each game consists of an assignment card, 16 image cards and 4 symbol cards. The cards belonging to each game are lined by both a symbol and a colored frame. By using a wooden stand (available separately), the children check their own work by looking at a picture on the back of the image card to see if everything is in the correct order. This is a simple, clever and colorful way of introducing preparatory math. Includes a partitioned wooden box with lid (31 x 29 x 8 cm) and instructions.

**Item Number: 522.237 - Five In A Row**

**Item Number: 522.200 - Five In A Row: Game Stand**

**Magnetic Counting Board**

A motor skills board, that can be used to playfully practice motor skills as well as gain numeric comprehension. Using the instruction cards with sample patterns, the colored balls are moved to the right place using the magnetic pen. Board size: 29.5 x 29.5 cm.

**Item Number: 522.952**

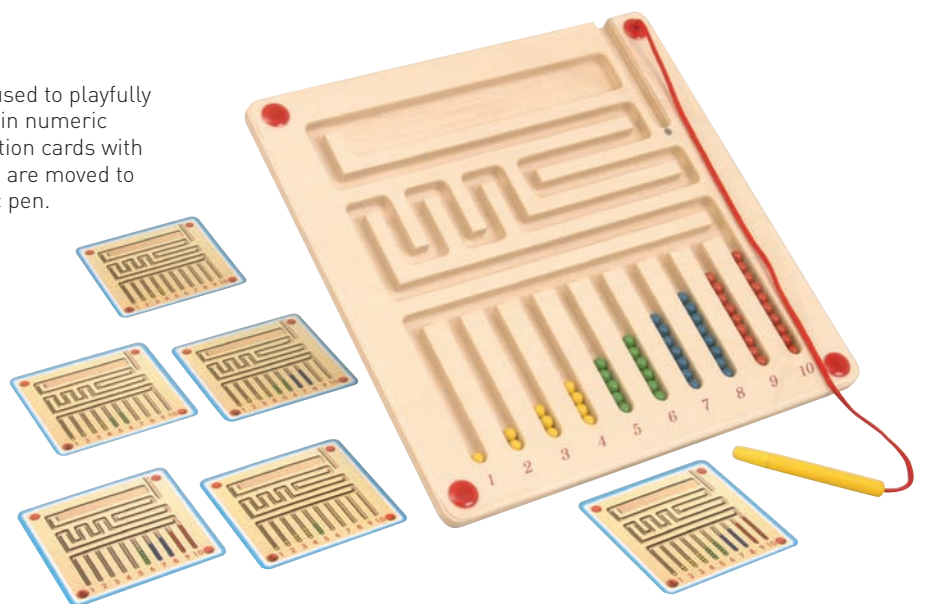

**Season Puzzle**

This 32-piece puzzle consists of seasonal scenes. Each scene is composed of eight pieces. Includes a wooden box with lid (25 x 14.5 x 5 cm) and instructions,

**Item Number: 3.226.00**



**Animal Combination Puzzle**

12 animals are illustrated on 24 wooden tablets, which the child pairs to complete each animal. As all tablets fit together, the child can make funny combinations. This encourages language development as a child tells about its own imaginary animals.

Contents:

- a wooden box with lid (28.5 x 14 x 5 cm)
- 24 wooden tablets (8.5 x 5.2 cm)
- instructions

**Item Number: 3.232.00**



Puzzles And Lottos

**Giant Floor Puzzles**

The detailed images printed on Trizzle, Dinos and Atlantis not only create much discussion by the children as they work to put it together, they also lend to the difficulty level in doing so. Each puzzle segment is triangular. When put together, they form one large hexagon (52 cm diameter). Each puzzle contains 24 triangular segments housed in a triangular box with lid (30 x 30 x 30 x 5 cm). Instructions are included.

Illustrations: E. van Masvelt

**Trizzle**  
Item Number: 3.856.00



**Atlantis**  
Item Number: 3.848.00



**Dinos**  
Item Number: 3.849.00





**Geo**

Geo teaches the child to distinguish and name geometric shapes. A circle, a square and a triangle are represented in various sizes and positions, as well as being separated into various pieces. Careful observation and concentration is required to complete the puzzles.

Contents:

- a wooden storage tray (26 x 26 x 2.5 cm)
- 4 puzzles, with 9 pieces each
- 4 pattern cards for self control
- instructions

Author: C.Wickeroth

**Item Number: 3.833.00**



**Block Puzzle**

This puzzle consists of 6 large oblong wooden blocks, that when put together, create an image of one of four animals - a duck, a sheep, a cow and a rabbit. All animals are depicted in one color per animal.

Contents:

- 6 oblong wooden blocks (3.5 x 3.5 x 20 cm)
- 1 wooden storage tray

**Item Number: 3.064.00**



## Puzzles And Lottos

### Flag Puzzles

Children find flags extremely interesting. The colors and shapes of the flags are so varied and captivating, they present many opportunities for practicing observation and learning geography, while having fun. Each 'flag' is created in two pieces. As the children fit the flags together, they compare color and shape. To check their work, when they turn over the completed section, if it is correct, the shape of the country will be visible. A control card is included.

Contents of each:

- a wooden storage tray (26 x 26 x 2.5 cm)
- 18 flags each separated into two segments.
- control card



**Flag Puzzle Of The Americas**

Item Number: 2.000.00

**Flag Puzzle Of Europe**

Item Number: 3.832.00



**Bas Dressing Puzzle**

The Bas Dressing Puzzle provides an opportunity to practice developmental areas such as: language, observation, motor skills and socio-emotional perceptions.

Contents:

- 2 puzzles in a puzzle frame (25 x 34 x 1.2 cm)
- the bottom puzzle shows an illustration of Bas in his underwear
- the top puzzle shows an illustration of Bas in his outerwear
- instructions

Illustrations: Dagmar Stam - ©: Uitgeverij Groen

**Item Number: 3.088.00**



**Tim Tom**

Tim Tom is a puzzle for children between the ages of 4 and 8 years old. The idea is for them to identify with Tim Tom, observe things in nature, and develop interest and awareness for all that lives and grows. A poster is included for creating a picture box. When completed, the Tim Tom puzzle measures: 72 x 48 cm.

Contents:

- a wooden box with lid (28.5 x 14.5 x 8.5 cm)
- 90 wooden puzzle pieces
- 1 square piece (18 x 12 cm)

Illustrations: E. van Masvelt

**Item Number: 3.852.00**



## Puzzles And Lottos Theme And Inlay Boards

### Photo Puzzles

A wonderful series of photo puzzles, one series with farm animals and one series with wild animals. The puzzles each contain 36 or 49 pieces and are available as a set of 4. Puzzle size: 34 x 34 cm.

**Photo Puzzles: Farm Animals - Set Of 4**  
Item Number: 523.003



**Photo Puzzles: Wild Animals - Set Of 4**  
Item Number: 522.989



### Duo Jigsaw Puzzles

The beauty of these puzzle is the way they are put together. The child places the 'center' square in the frame and builds off of this piece. As they work, the pieces are turned in all directions in order to match the correct images. Each puzzle consists of 15 pieces (including the center square). Puzzle size: 36 x 36 cm.

**Duo Jigsaw Puzzle: 1**  
Item Number: 522.874

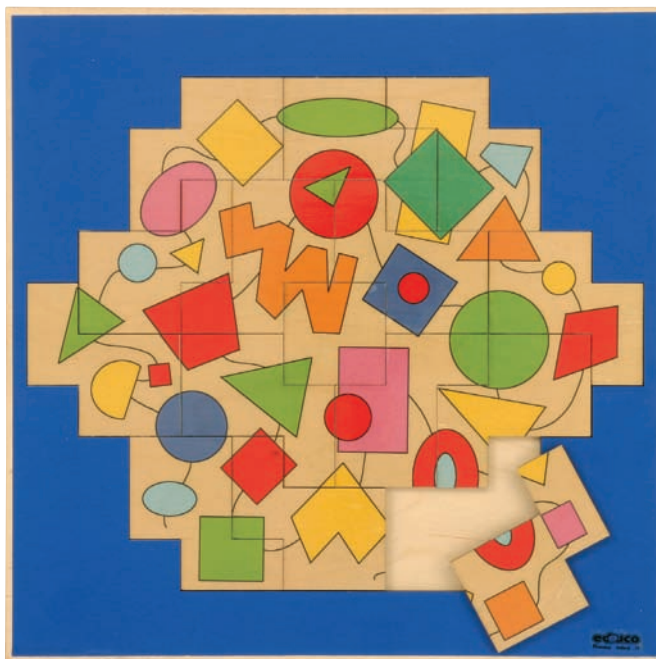

**Duo Jigsaw Puzzle: 2**  
Item Number: 522.966



## Puzzles And Lottos Theme And Inlay Boards

### Fruit/Animal Inlay Boards

With 10 lift-out shapes in each scene, these boards use large easy-grip, lift-out knobs and are suitable for the 2-4 age group.  
Puzzle size: 28 x 28 cm.

**Inlay Board Puzzle: Fruit**  
Item Number: 522.636

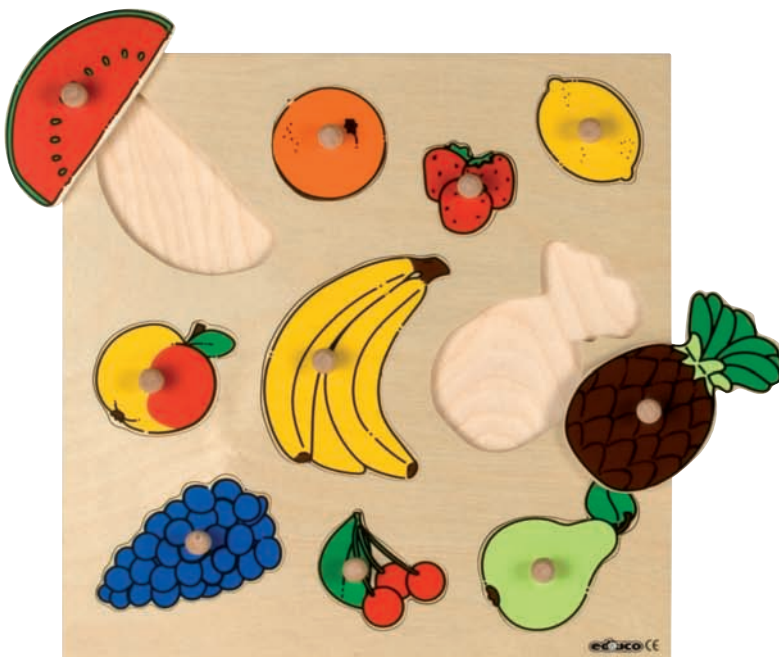

**Inlay Board Puzzle: Animals**  
Item Number: 522.637

### Triama

Two challenging and highly unusual jigsaws where all the pieces are triangular. Full of lovely images, each Triama contains 24 pieces. Puzzle size: 34 x 34 cm.

**Triama: Butterflies Puzzle**  
Item Number: 522.825



**Triama: Flowers Puzzle**  
Item Number: 522.826

Puzzles And Lottos  
Theme And Inlay Boards



Inlay Board Puzzle: Profession Circle  
Item Number: 523.039

Inlay Board Puzzle: Animals Circle  
Item Number: 522.872





**Growth Puzzles**

A series of layered puzzles, which show how things grow. Each phase of growth is larger and requires more pieces to complete the picture. Each puzzle contains 31 pieces. Puzzle size: 24 x 24 x 2 cm.



**Tulip**  
Item Number: 522.009

**Grandmother**  
Item Number: 522.011

**Bird**  
Item Number: 522.016

**Sunflower**  
Item Number: 522.018

Puzzles And Lottos

Growth And Layer Puzzles

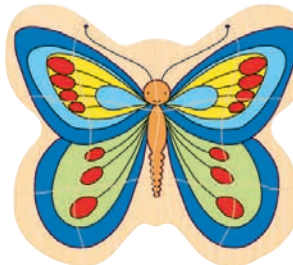
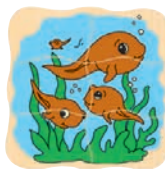

Chicken

Item Number: 522.012

Frog

Item Number: 522.013

Butterfly

Item Number: 522.014

Grandfather

Item Number: 522.015

**Growth Puzzles**

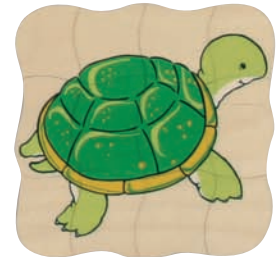
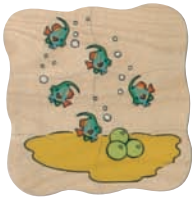

**Fish**  
Item Number: 522.218

**Peacock**  
Item Number: 522.219

**Parrot**  
Item Number: 522.220

**Turtle**  
Item Number: 522.221

## Puzzles And Lottos

### Growth And Layer Puzzles

#### Layer Puzzle: Daily Routine

A four layer level puzzle which shows the daily routine of a child. The first layer contains 4 puzzle pieces, the second layer 8 pieces, the third layer 12 pieces, and the last contains 16 puzzle pieces. Puzzle size: 30 x 30 cm.

**Item Number: 523.060**



### Floor Puzzles

2 large floor puzzles featuring scenes familiar to young children: the House, and the Farm. Each floor puzzle comes in a wooden box with lid (40 x 34 x 8 cm). On the lid is a printed picture of the completed puzzle for the child to use as a guide if necessary. Puzzle size: 60 x 60 cm.

**Floor Puzzle: The Farm**  
Item Number: 522.077



**Floor Puzzle: The House**  
Item Number: 522.078



## Puzzles And Lottos

### Floor Puzzles

#### Floor Puzzle: The Zoo

The Zoo Floor Puzzle is fun in that it is 4 puzzles in one when completed. The 4 individual puzzles can be put together to form one large puzzle (72 x 72 cm). 2 of the puzzles contain 9 pieces and the other 2 contain 16.

**Item Number: 522.965**





### Sand Bucket And Sieves

Solid plastic buckets with strong plastic handles and a wide rim for easy pouring. The sieves are 14.5 cm diameter and fit exactly over the top of the bucket. Comes in assorted colors.

**Item Number: 522.771 - Sand Bucket: Assorted Colors**

**Item Number: 522.776 - Sand Bucket: Transparent**

**Item Number: 522.772 - Sieves for the Sand Bucket**

### Sand Shovel: Red (80 cm)

Made of durable plastic.

**Item Number: 522.773**

### Sand Shovel: Yellow (65 cm)

Made of durable plastic.

**Item Number: 522.774**



### Sand Rake: Blue (75 cm)

Made of durable plastic.

**Item Number: 522.775**

## Outdoor Play

### Sand And Water Scoop

Easy-to-use scoop for both sand and water.  
Made of durable plastic. Assorted colors.

**Item Number: 522.765**



### Geometric Sand Shapes: Set Of 8

2 each of 4 different geometric shapes: circle, rectangle, triangle and square. Made of durable plastic.

**Item Number: 522.848**



### Bug Box With Magnifying Lid

A fun plastic jar used to temporarily capture bugs or other creatures so they can be observed. The magnifying glass that serves as the lid to the jar enables the children to see up-close the bug and observe its form and movement.

**Item Number: 522.022**





# Bikes And Trikes

Outdoor play is essential... It is outdoors where children train their large motor skills, and develop physically, mentally, and socially. Outdoor play contributes to a child's cognitive and social-emotional development. While they play, they also learn.

On the following pages you will find a selection of Winther bikes for your outdoor play area. Winther is a family company that started in 1932. For decades, the Winther brand has focused on making high-quality trikes and bikes for the educational market. Their concept is: "Learning by moving".

As a result of their close cooperation with industrial designers and physiotherapists, their products are designed using ergonomic principles in accordance with a child's development - both physically and with regard to age. They put great emphasis on safety and durability and manufacture products that both children and adults find attractive. Each bike and trike has a resilient powder coating that creates a very strong, impact-proof surface that inhibits rusting. There are no sharp edges that could cause injury, the frames and forks are fully guaranteed, and their products comply with all current safety standards.

Here, we proudly introduce the Winther Circleline and Duo series, as well as the bikes and trikes that Winther exclusively makes for our own Educo brand. Next to each selection you will find the appropriate age range and dimensions. Since safety is also of great importance to us, a child-sized helmet is included with each bike or trike purchase.

**Free helmet**  
with the purchase of any  
bicycle or tricycle.



**Wooden Toddler Trike**

Seat Height: 9.1 inches. Ages: 0-3 years.

**Item Number: 523.104**



**Educo (by Winther) Tricycle: Small**

Seat Height: 11.8 inches. Ages: 2-4 years.

**Item Number: 500.110**

**Educo (by Winther) Tricycle: Medium**

Seat Height: 15 inches. Ages: 3-6 years.

**Item Number: 500.111**



**Educo (by Winther) Tricycle: Easy Rider**

Seat Height: 7.9 inches. Ages: 4-7 years.

**Item Number: 500.112**



### **Educo (by Winther) Tricycle: Taxi**

Seat Height: 15 inches. Ages: 3-7 years.

**Item Number: 500.113**

**Free helmet**  
with the purchase of any  
bicycle or tricycle.



### **Educo (by Winther): Scooter**

Ages: 3-5 years.

**Item Number: 500.114**



### **Educo (by Winther): Bicycle**

Seat Height: 13.4 inches. Ages: 3-6 years.

**Item Number: 500.115**

## Winther Tricycles

The Winther brand is known for producing tricycles and bicycles that are durable, safe and reliable. The Duo line is the new range developed especially for the youngest children. The size is a bit smaller, the seats a bit lower. Perfect for 1 – 4 year old children. The Circleline range is the new heavy-duty line. It includes the classic tricycle as well as scooters, taxis and other exciting versions. All Winther tricycles are easy to ride, train the muscles and develop motor skills.

### Winther Duo: Toddler Tricycle - Small

Seat Height: 9.8 inches. Ages: 1-4 years.

**Item Number: 2.419.00**



### Winther Circleline: Tricycle - Small

Seat Height: 10.5 inches. Ages: 2-4 years.

**Item Number: 2.420.00**



### Winther Circleline: Tricycle - Medium

Seat Height: 13.5 inches. Ages: 3-6 years.

**Item Number: 2.421.00**



### Winther Circleline: Tricycle - Large

Seat Height: 16 inches. Ages: 4-8 years.

**Item Number: 2.422.00**



### Winther Circleline: Tricycle - Easy Rider

Seat Height: 7.5 inches. Ages: 4-7 years.

Item Number: 2.423.00

### Winther Circleline: Tricycle - Taxi

Seat Height: 14 inches. Ages: 3-7 years.

Item Number: 2.424.00



### Free helmet

with the purchase of any bicycle or tricycle.



### Winther Circleline: Tricycle - Push Bike

Seat Height: 10.5 inches. Ages: 2-4 years.

Item Number: 2.426.00



**Winther Circleline: Tricycle - Truck**

Seat Height: 14.5 inches. Ages: 4-8 years.

**Item Number: 2.427.00**

**Winther Circleline: Tricycle - Police**

Seat Height: 13.5 inches. Ages: 4-8 years.

**Item Number: 2.428.00**



**Winther Circleline: Tricycle - Fire Truck**

Seat Height: 13.5 inches. Ages: 4-8 years.

**Item Number: 2.429.00**



### Winther Circleline: Tricycle - Ambulance

Seat Height: 13.5 inches. Ages: 4-8 years.

Item Number: 2.430.00

### Winther Circleline: Tricycle - School Bus

Seat Height: 13.5 inches. Ages: 4-8 years.

Item Number: 2.431.00



### Free helmet

with the purchase of any bicycle or tricycle.



### Winther Circleline: Scooter

Ages: 3-5 years

Item Number: 2.425.00





# Spareparts

Nienhuis bases its success on the manufacturing of high quality Montessori materials, innovative product development, and superb customer service. It doesn't stop there...

We proudly present our selection of Spareparts. There are 1500+ items. Beads, cubes, tablets, knobs, puzzle pieces... Just about anything you might need to keep your classroom in the best possible condition.

The collection is organized by category – Infant Toddler, Practical Life, Sensorial, Language, etc. Each particular page shows the individual Sparepart and its corresponding 'whole' product. Take the Pink Tower for example: this page shows a sizeable image of the Pink Tower, and thumbnail images of each individual cube. The item numbers and descriptions are included.

We feel confident that we succeeded in creating a layout that is not only clear, but also thorough and easy to use.

**Infant Toddler**



**0.411.00.01**  
Object Permanence  
Box: Plastic Ball



**0.421.00.01**  
Imbucare Box:  
Red Cylinder  
3.5 x 4



**0.422.00.01**  
Imbucare Box:  
Red Cylinder  
2.5 x 4



**0.423.00.01**  
Imbucare Box:  
Blue Cube  
4 x 4 x 4



**0.424.00.01**  
Imbucare Box:  
Yellow 3 Side Prism  
4 x 4



**0.425.00.01**  
Imbucare Box:  
Green Rectangular Prism  
4 x 4 x 2



**0.431.00.01**  
Imbucare Peg Box:  
Yellow Peg  
2 x 7



**0.431.00.02**  
Imbucare Peg Box:  
Red Peg  
2 x 7



**0.431.00.03**  
Imbucare Peg Box:  
Blue Peg  
2 x 7



**0.432.00.01**  
Imbucare Box:  
Yellow Knit Ball



**0.451.00.01**  
Cubes On Vertical Dowel:  
Blue Cube  
3.2 x 3.2 x 3.2



**0.452.00.01**  
For Item: 0.456.00  
Red Wooden Ring  
4 x 1.4



**0.452.00.02**  
For Item:  
0.456.00/0.458.00  
Blue Wooden Ring  
4 x 1.4



**0.452.00.03**  
For Item: 0.456.00  
Yellow Wooden Ring  
4 x 1.4



**0.452.00.04**  
For Item:  
0.454.00/0.455.00  
Green Wooden Ring  
4 x 1.4



**0.453.00.01**  
Discs On Horizontal Dowel:  
Green Wooden Ring  
5 x 1.2

**Practical Life**



**0.010.00.01**  
Shoe Buttoning Frame:  
Hook

## Sensorial



**0.024.00.01**  
Pink Tower Cube:  
1 x 1 x 1



**0.024.00.02**  
Pink Tower Cube:  
1 x 1 x 1 - (5)



**0.024.00.03**  
Pink Tower Cube:  
2 x 2 x 2



**0.024.00.04**  
Pink Tower Cube:  
2 x 2 x 2 - (5)



**0.024.00.05**  
Pink Tower Cube:  
3 x 3 x 3



**0.024.00.06**  
Pink Tower Cube:  
4 x 4 x 4



**0.024.00.07**  
Pink Tower Cube:  
5 x 5 x 5



**0.024.00.08**  
Pink Tower Cube:  
6 x 6 x 6



**0.024.00.09**  
Pink Tower Cube:  
7 x 7 x 7



**0.024.00.10**  
Pink Tower Cube:  
8 x 8 x 8



**0.024.00.11**  
Pink Tower Cube:  
9 x 9 x 9



**0.024.00.12**  
Pink Tower Cube:  
10 x 10 x 10



**0.024.20.01**  
Unpainted Cube:  
1 x 1 x 1



**0.024.20.02**  
Unpainted Cube:  
1 x 1 x 1 - (10)





**0.025.00.01**  
Brown Stair Prism:  
Clear Lacquer  
20 x 1 x 1



**0.025.00.06**  
Brown Stair Prism:  
Clear Lacquer  
20 x 6 x 6



**0.025.00.02**  
Brown Stair Prism:  
Clear Lacquer  
20 x 2 x 2



**0.025.00.07**  
Brown Stair Prism:  
Clear Lacquer  
20 x 7 x 7



**0.025.00.03**  
Brown Stair Prism:  
Clear Lacquer  
20 x 3 x 3



**0.025.00.08**  
Brown Stair Prism:  
Clear Lacquer  
20 x 8 x 8



**0.025.00.04**  
Brown Stair Prism:  
Clear Lacquer  
20 x 4 x 4



**0.025.00.09**  
Brown Stair Prism:  
Clear Lacquer  
20 x 9 x 9



**0.025.00.05**  
Brown Stair Prism:  
Clear Lacquer  
20 x 5 x 5



**0.025.00.10**  
Brown Stair Prism:  
Clear Lacquer  
20 x 10 x 10



## Sensorial



**0.025.50.01**  
Brown Stair Prism:  
Brown Lacquer  
20 x 1 x 1



**0.025.50.06**  
Brown Stair Prism:  
Brown Lacquer  
20 x 6 x 6



**0.025.50.02**  
Brown Stair Prism:  
Brown Lacquer  
20 x 2 x 2



**0.025.50.07**  
Brown Stair Prism:  
Brown Lacquer  
20 x 7 x 7



**0.025.50.03**  
Brown Stair Prism:  
Brown Lacquer  
20 x 3 x 3



**0.025.50.08**  
Brown Stair Prism:  
Brown Lacquer  
20 x 8 x 8



**0.025.50.04**  
Brown Stair Prism:  
Brown Lacquer  
20 x 4 x 4



**0.025.50.09**  
Brown Stair Prism:  
Brown Lacquer  
20 x 9 x 9



**0.025.50.05**  
Brown Stair Prism:  
Brown Lacquer  
20 x 5 x 5



**0.025.50.10**  
Brown Stair Prism:  
Brown Lacquer  
20 x 10 x 10



**0.025.20.01**  
Unpainted Prism:  
20 x 1 x 1



**Sensorial**



**0.019.00.01**  
1st Cylinder Of  
Block No. 1



**0.019.00.05**  
5th Cylinder Of  
Block No. 1



**0.019.00.09**  
9th Cylinder Of  
Block No. 1



**0.019.00.02**  
2nd Cylinder Of  
Block No. 1



**0.019.00.06**  
6th Cylinder Of  
Block No. 1



**0.019.00.10**  
10th Cylinder Of  
Block No. 1



**0.019.00.03**  
3rd Cylinder Of  
Block No. 1



**0.019.00.07**  
7th Cylinder Of  
Block No. 1



**0.019.00.11**  
Knob For Cylinders:  
Thick (1)



**0.019.00.04**  
4th Cylinder Of  
Block No. 1



**0.019.00.08**  
8th Cylinder Of  
Block No. 1



**0.019.00.12**  
Knob For Cylinders:  
Thick (10)

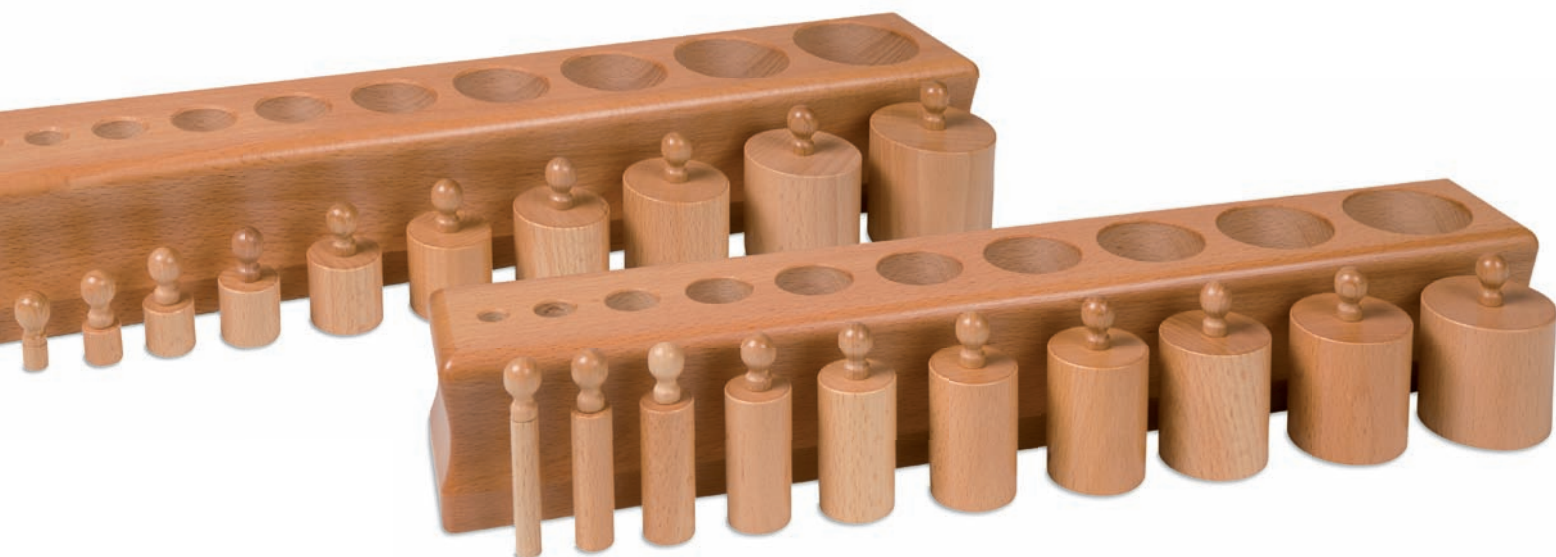

**0.020.00.01**  
1st Cylinder Of  
Block No. 2



**0.020.00.05**  
5th Cylinder Of  
Block No. 2



**0.020.00.09**  
9th Cylinder Of  
Block No. 2



**0.020.00.02**  
2nd Cylinder Of  
Block No. 2



**0.020.00.06**  
6th Cylinder Of  
Block No. 2



**0.020.00.10**  
10th Cylinder Of  
Block No. 2



**0.020.00.03**  
3rd Cylinder Of  
Block No. 2



**0.020.00.07**  
7th Cylinder Of  
Block No. 2



**0.020.00.11**  
Knob For Cylinders:  
Thin (1)



**0.020.00.04**  
4th Cylinder Of  
Block No. 2



**0.020.00.08**  
8th Cylinder Of  
Block No. 2



**0.020.00.12**  
Knob For Cylinders:  
Thin (10)

## Sensorial



**0.021.00.01**  
1st Cylinder Of  
Block No. 3



**0.021.00.05**  
5th Cylinder Of  
Block No. 3



**0.021.00.08**  
8th Cylinder Of  
Block No. 3



**0.021.00.02**  
2nd Cylinder Of  
Block No. 3



**0.021.00.06**  
6th Cylinder Of  
Block No. 3



**0.021.00.09**  
9th Cylinder Of  
Block No. 3



**0.021.00.03**  
3rd Cylinder Of  
Block No. 3



**0.021.00.07**  
7th Cylinder Of  
Block No. 3



**0.021.00.10**  
10th Cylinder Of  
Block No. 3



**0.021.00.04**  
4th Cylinder Of  
Block No. 3



**0.022.00.01**  
1st Cylinder Of  
Block No. 4



**0.022.00.05**  
5th Cylinder Of  
Block No. 4



**0.022.00.08**  
8th Cylinder Of  
Block No. 4



**0.022.00.02**  
2nd Cylinder Of  
Block No. 4



**0.022.00.06**  
6th Cylinder Of  
Block No. 4



**0.022.00.09**  
9th Cylinder Of  
Block No. 4



**0.022.00.03**  
3rd Cylinder Of  
Block No. 4



**0.022.00.07**  
7th Cylinder Of  
Block No. 4



**0.022.00.10**  
10th Cylinder Of  
Block No. 4



**0.022.00.04**  
4th Cylinder Of  
Block No. 4





**0.023.00.01**  
1st Yellow Cylinder

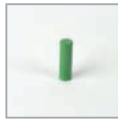

**0.023.00.09**  
2nd Green Cylinder



**0.023.00.17**  
4th Green Cylinder



**0.023.00.02**  
1st Yellow Cylinder (5)

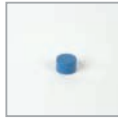

**0.023.00.10**  
2nd Blue Cylinder



**0.023.00.18**  
4th Blue Cylinder



**0.023.00.03**  
1st Red Cylinder



**0.023.00.11**  
3rd Yellow Cylinder



**0.023.00.19**  
5th Yellow Cylinder



**0.023.00.04**  
1st Green Cylinder



**0.023.00.12**  
3rd Red Cylinder



**0.023.00.20**  
5th Red Cylinder



**0.023.00.05**  
1st Blue Cylinder



**0.023.00.13**  
3rd Green Cylinder



**0.023.00.21**  
5th Green Cylinder



**0.023.00.06**  
2nd Yellow Cylinder



**0.023.00.14**  
3rd Blue Cylinder



**0.023.00.22**  
5th Blue Cylinder



**0.023.00.07**  
2nd Yellow Cylinder (5)



**0.023.00.15**  
4th Yellow Cylinder



**0.023.00.23**  
6th Yellow Cylinder



**0.023.00.08**  
2nd Red Cylinder



**0.023.00.16**  
4th Red Cylinder



**0.023.00.24**  
6th Red Cylinder

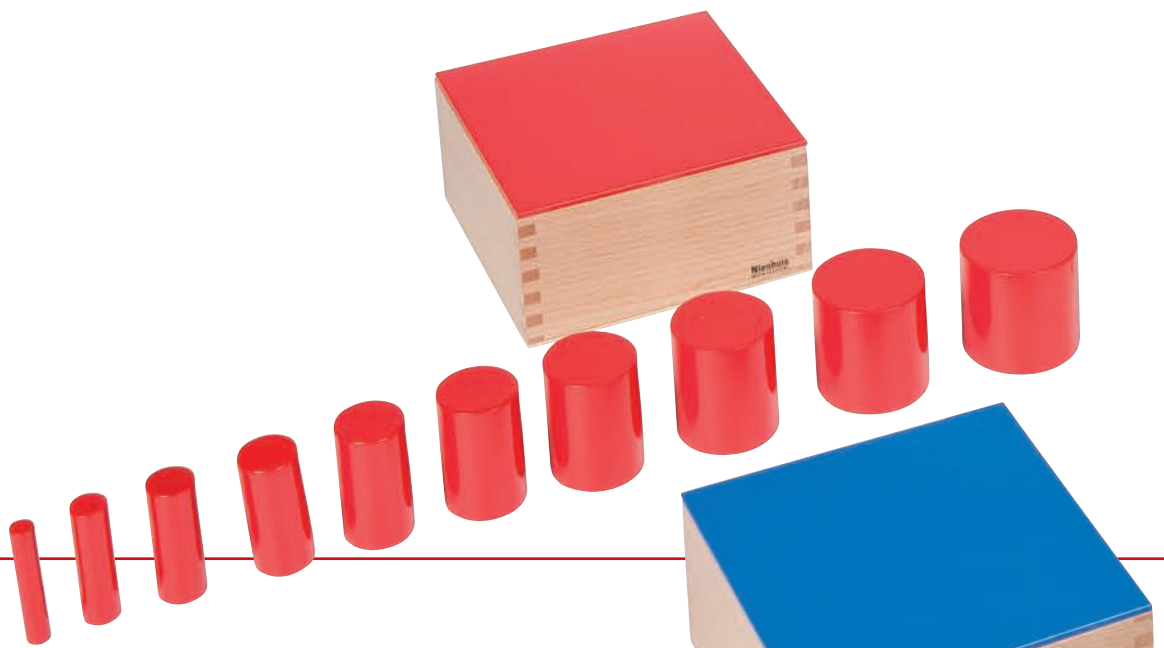

## Sensorial

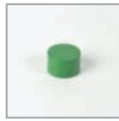

**0.023.00.25**  
6th Green Cylinder



**0.023.00.26**  
6th Blue Cylinder



**0.023.00.27**  
7th Yellow Cylinder



**0.023.00.28**  
7th Red Cylinder



**0.023.00.29**  
7th Green Cylinder



**0.023.00.30**  
7th Blue Cylinder



**0.023.00.31**  
8th Yellow Cylinder

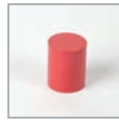

**0.023.00.32**  
8th Red Cylinder



**0.023.00.33**  
8th Green Cylinder



**0.023.00.34**  
8th Blue Cylinder



**0.023.00.35**  
9th Yellow Cylinder



**0.023.00.36**  
9th Red Cylinder



**0.023.00.37**  
9th Green Cylinder



**0.023.00.38**  
9th Blue Cylinder



**0.023.00.39**  
10th Yellow Cylinder

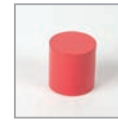

**0.023.00.40**  
10th Red Cylinder



**0.023.00.41**  
10th Green Cylinder



**0.023.00.42**  
10th Blue Cylinder



**0.023.00.43**  
Knobless Cylinders Box:  
Empty



**0.023.00.44**  
Knobless Cylinders Box:  
Lid - Yellow



**0.023.00.45**  
Knobless Cylinders Box:  
Lid - Red



**0.023.00.46**  
Knobless Cylinders Box:  
Lid - Green



**0.023.00.47**  
Knobless Cylinders Box:  
Lid - Blue

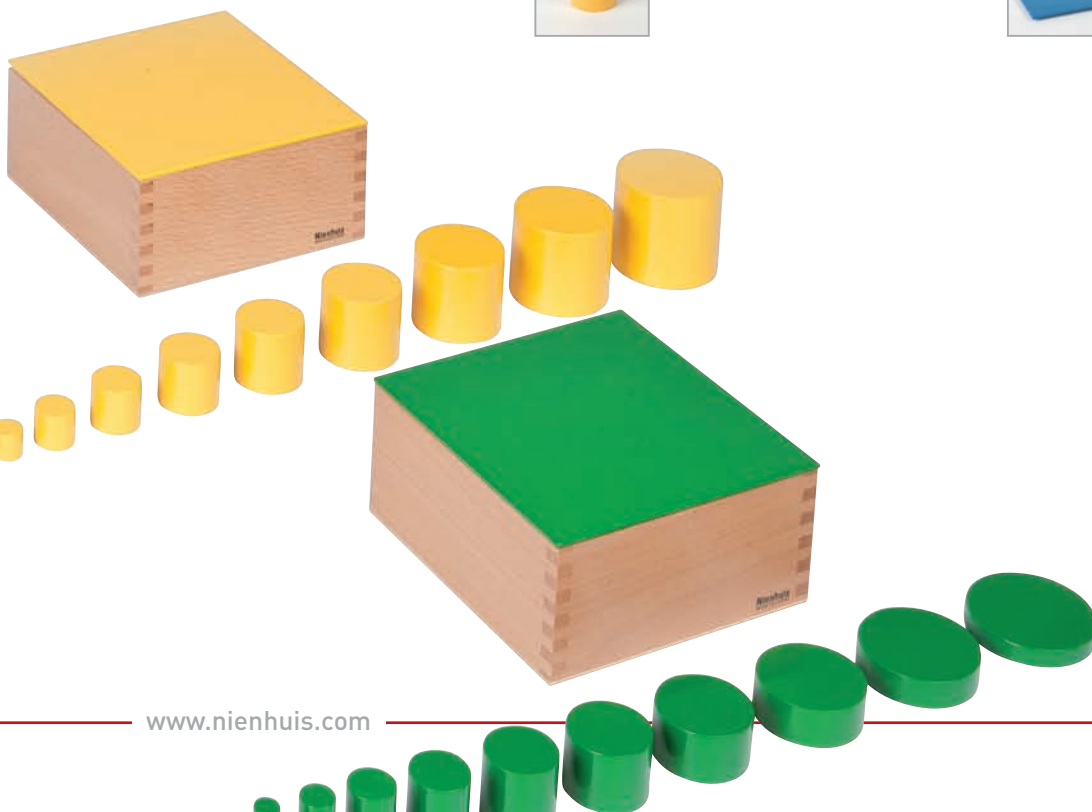



**0.026.00.01**  
Red Rod And  
Number Rod Prism:  
10 cm



**0.026.00.02**  
Red Rod Prism:  
20 cm



**0.026.00.03**  
Red Rod Prism:  
30 cm

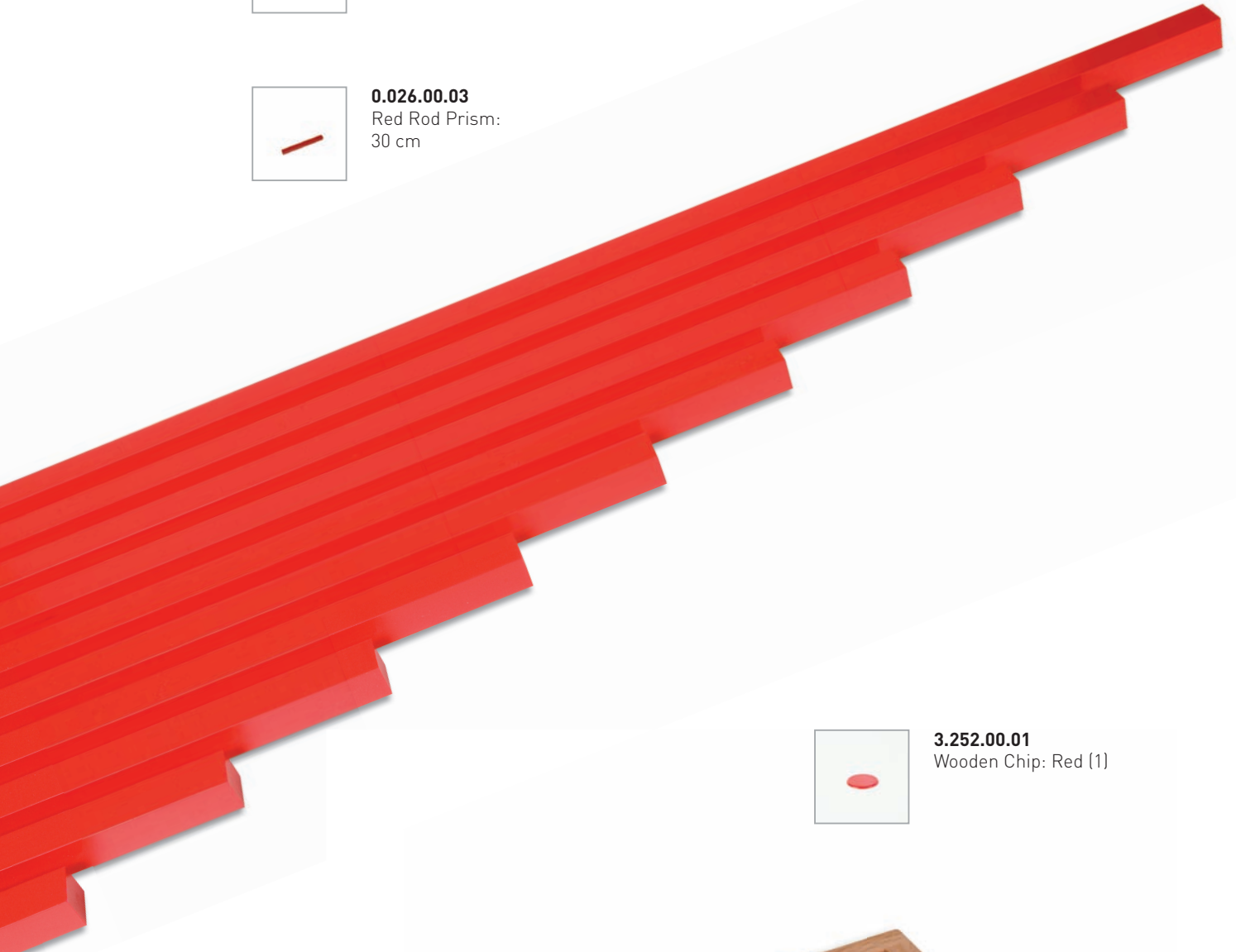

**3.252.00.01**  
Wooden Chip: Red (1)



## Sensorial



**0.051.00.01**  
Color Tablet:  
Red (2)



**0.051.00.02**  
Color Tablet:  
Yellow (2)

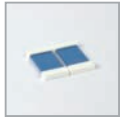

**0.051.00.03**  
Color Tablet:  
Blue (2)



**0.051.00.04**  
Edge For Color Tablet:  
White



**0.052.00.01**  
Color Tablet:  
Yellow (2)



**0.052.00.02**  
Color Tablet:  
Green (2)



**0.052.00.03**  
Color Tablet:  
Pink (2)



**0.052.00.04**  
Color Tablet:  
Orange (2)



**0.052.00.05**  
Color Tablet:  
Gray (2)



**0.052.00.06**  
Color Tablet:  
Brown (2)



**0.052.00.07**  
Color Tablet:  
Purple (2)



**0.052.00.08**  
Color Tablet:  
White (2)

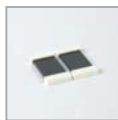

**0.052.00.09**  
Color Tablet:  
Black (2)

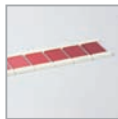

**0.053.00.01**  
Color Tablet:  
Series Of 7 - Red

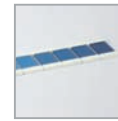

**0.053.00.02**  
Color Tablet:  
Series Of 7 - Blue



**0.053.00.03**  
Color Tablet:  
Series Of 7 - Yellow

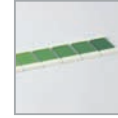

**0.053.00.04**  
Color Tablet:  
Series Of 7 - Green



**0.053.00.05**  
Color Tablet:  
Series Of 7 - Pink

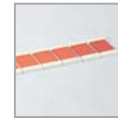

**0.053.00.06**  
Color Tablet:  
Series Of 7 - Orange

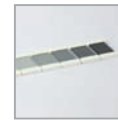

**0.053.00.07**  
Color Tablet:  
Series Of 7 - Gray

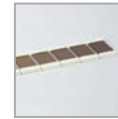

**0.053.00.08**  
Color Tablet:  
Series Of 7 - Brown

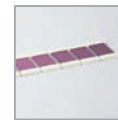

**0.053.00.09**  
Color Tablet:  
Series Of 7 - Purple





**0.012.A0.01**  
First Rough And Smooth Board



**0.012.A0.03**  
Third Rough And Smooth Board



**0.012.A0.02**  
Second Rough And Smooth Board



**0.017.00.01**  
Baric Tablets:  
Wooden Tablet - Light (1)

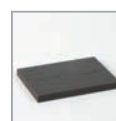

**0.017.00.03**  
Baric Tablets:  
Wooden Tablet - Heavy (1)



**0.017.00.02**  
Baric Tablets:  
Wooden Tablet - Medium (1)



**0.018.A0.01**  
Thermic Tablets:  
Metal Tablet (1)



**0.018.A0.03**  
Thermic Tablets:  
Stone Tablet (1)



**0.018.A0.02**  
Thermic Tablets:  
Wooden Tablet (1)



**0.018.A0.04**  
Thermic Tablets:  
Felt Tablet (1)



**0.018.A0.05**  
Thermic Tablets:  
Glass Tablet (1)



**0.018.A0.06**  
Thermic Tablets:  
Cork Tablet (1)

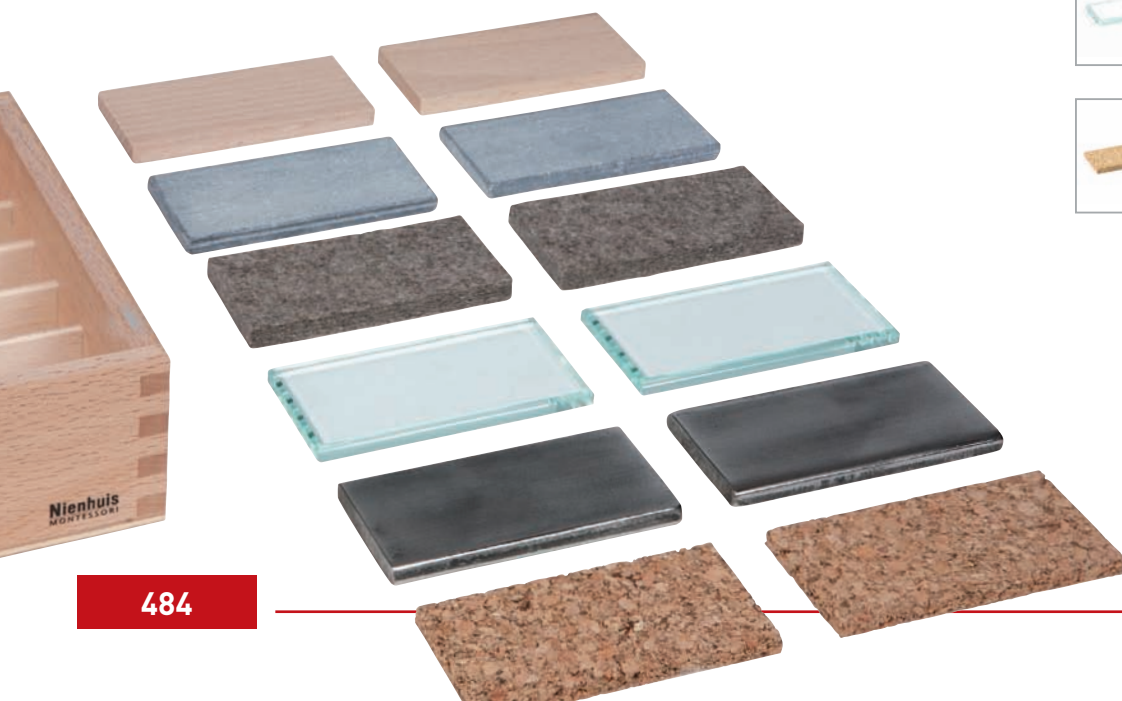

## Sensorial



**0.015.70.01**  
Tasting Exercise:  
Drop Bottle



**0.015.70.02**  
Tasting Exercise:  
Dropper With Screw Cap  
- Black/Red



**0.015.70.03**  
Tasting Exercise:  
Dropper With Screw Cap  
- Black/Black



**0.015.00.05**  
Smelling Bottle:  
Light Gray



**0.015.00.06**  
Smelling Bottle:  
Dark Gray



**0.018.00.01**  
One Thermic Bottle





**0.049.00.01**  
Triangle Box:  
Equilateral Triangle  
- Gray



**0.049.00.02**  
Small Hexagon Box:  
Equilateral Triangle  
- Yellow



**0.049.00.03**  
Blue Rectangle Box:  
Equilateral Triangle  
- Blue



**0.049.00.04**  
Blue Rectangle Box:  
Small Scalene Triangle  
- Blue



**0.049.00.05**  
Blue Rectangle Box:  
Right-Angled Scalene Triangle  
- Blue



**0.049.00.06**  
Blue Rectangle Box:  
Large Scalene Triangle  
- Blue



**0.049.00.07**  
Blue Rectangle Box:  
Right-Angled Isosceles Triangle  
- Blue



**0.049.00.08**  
Large Hexagon Box:  
Equilateral Triangle  
- Yellow / \



**0.049.00.09**  
Small Hexagon Box:  
Equilateral Triangle  
- Green \_



**0.049.00.10**  
Small Hexagon Box:  
Equilateral Triangle  
- Green / \



**0.049.00.11**  
Rectangle Box:  
Equilateral Triangle  
- Yellow \_



**0.049.00.12**  
Small Hexagon/Triangle Box:  
Equilateral Triangle  
- Red \_



**0.049.00.13**  
Triangle Box:  
Equilateral Triangle  
- Red / \



**0.049.00.14**  
Small Hexagon Box:  
Equilateral Triangle  
- Gray / \



**0.049.00.15**  
Large Hexagon/Triangle Box:  
Isosceles Triangle  
- Yellow / \



**0.049.00.16**  
Large Hexagon Box:  
Isosceles Triangle  
- Yellow \_



**0.049.00.17**  
Large Hexagon Box:  
Isosceles Triangle  
- Gray /



**0.049.00.18**  
Large Hexagon Box:  
Isosceles Triangle  
- Red \_

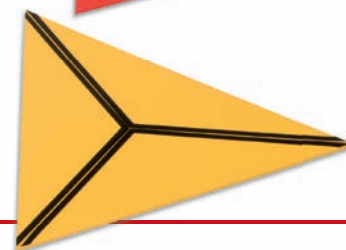
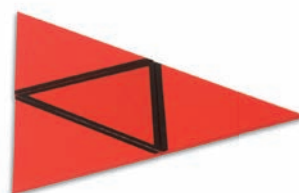
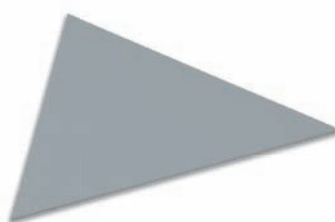

## Sensorial



**0.049.00.19**  
Small Hexagon Box:  
Isosceles Triangle  
- Red \_



**0.049.00.20**  
Rectangle Box:  
Small Scalene Triangle  
- Red \_



**0.049.00.21**  
Triangle Box:  
Right-Angled Scalene  
Triangle - Green Left - I



**0.049.00.22**  
Triangle Box:  
Right-Angled Scalene  
Triangle - Green Right - I



**0.049.00.23**  
Rectangle Box:  
Right-Angled Scalene  
Triangle - Green - I



**0.049.00.24**  
Rectangle Box:  
Small Scalene Triangle  
- Yellow



**0.049.00.25**  
Rectangle Box:  
Right-Angled Scalene  
Triangle - Gray \



**0.049.00.26**  
Rectangle Box:  
Large Scalene Triangle  
- Red I



**0.049.00.27**  
Rectangle Box:  
Right-Angled Isosceles  
Triangle - Green \



**0.049.00.28**  
Rectangle Box:  
Large Scalene Triangle  
- Yellow \_



**0.049.00.29**  
Rectangle Box:  
Empty



**0.049.00.30**  
Rectangle Box:  
Lid



**0.049.00.31**  
Triangle Box:  
Empty



**0.049.00.32**  
Triangle Box:  
Lid



**0.049.00.33**  
Small Hexagon Box:  
Empty



**0.049.00.34**  
Small Hexagon Box:  
Lid



**0.049.00.35**  
Large Hexagon Box:  
Empty



**0.049.00.36**  
Large Hexagon Box:  
Lid

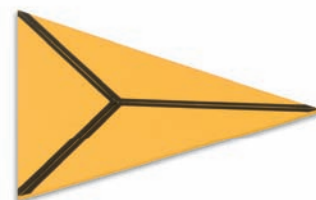





**0.045.00.01**  
Contents Of Circles,  
Squares And Triangles



**0.037.00.11**  
Geometric Cabinet Inset:  
Rectangle 6 x 10



**0.037.00.18**  
Geometric Cabinet Inset:  
Circle 7 cm

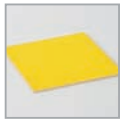

**0.037.00.02**  
Geometric Cabinet Inset:  
Blank Square



**0.037.00.12**  
Geometric Cabinet Inset:  
Rectangle 7 x 10



**0.037.00.19**  
Geometric Cabinet Inset:  
Circle 8 cm



**0.037.00.03**  
White Knobs:  
For Maps/Insets/Puzzles (1)



**0.037.00.13**  
Geometric Cabinet Inset:  
Rectangle 8 x 10



**0.037.00.20**  
Geometric Cabinet Inset:  
Circle 9 cm



**0.037.00.04**  
White Knobs:  
For Maps/Insets/Puzzles (10)



**0.037.00.14**  
Geometric Cabinet Inset:  
Rectangle 9 x 10



**0.037.00.21**  
Geometric Cabinet Inset:  
Circle 10 cm



**0.037.00.05**  
White Knobs:  
For Maps/Insets/Puzzles (25)



**0.037.00.15**  
Geometric Cabinet Inset:  
Rectangle 10 x 10



**0.037.00.22**  
Geometric Cabinet Inset:  
Right-Angled Scalene  
Triangle



**0.037.00.07**  
Contents Of  
The Geometric Cabinet



**0.037.00.16**  
Geometric Cabinet Inset:  
Circle 5 cm



**0.037.00.23**  
Geometric Cabinet Inset:  
Right-Angled Isosceles  
Triangle



**0.037.00.10**  
Geometric Cabinet Inset:  
Rectangle 5 x 10



**0.037.00.17**  
Geometric Cabinet Inset:  
Circle 6 cm



**0.037.00.24**  
Geometric Cabinet Inset:  
Obtuse-Angled Isosceles  
Triangle



## Sensorial



**0.037.00.25**  
Geometric Cabinet Inset:  
Acute Angled Isosceles  
Triangle



**0.037.00.32**  
Geometric Cabinet Inset:  
Octagon



**0.037.00.39**  
Geometric Cabinet Inset:  
Trapezoid 10 x 7.5



**0.037.00.26**  
Geometric Cabinet Inset:  
Equilateral Triangle



**0.037.00.33**  
Geometric Cabinet Inset:  
Nonagon



**0.037.00.40**  
Geometric Cabinet Inset:  
Quadrilateral  
10 x 7



**0.037.00.27**  
Geometric Cabinet Inset:  
Acute Angled Scalene  
Triangle



**0.037.00.34**  
Geometric Cabinet Inset:  
Decagon



**0.037.00.41**  
Geometric Cabinet Inset:  
Chevron

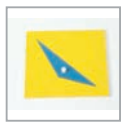

**0.037.00.28**  
Geometric Cabinet Inset:  
Obtuse Angled Scalene  
Triangle



**0.037.00.35**  
Geometric Cabinet Inset:  
Oval



**0.037.00.42**  
Geometric Cabinet Inset:  
Kite



**0.037.00.29**  
Geometric Cabinet Inset:  
Pentagon



**0.037.00.36**  
Geometric Cabinet Inset:  
Ellipse



**0.037.00.43**  
Geometric Cabinet Inset:  
Quadrilateral



**0.037.00.30**  
Geometric Cabinet Inset:  
Hexagon



**0.037.00.37**  
Geometric Cabinet Inset:  
Rhombus 9.2 x 9



**0.037.00.44**  
Geometric Cabinet Inset:  
Curvilinear Triangle



**0.037.00.31**  
Geometric Cabinet Inset:  
Heptagon



**0.037.00.38**  
Geometric Cabinet Inset:  
Parallelogram 9.2 x 6

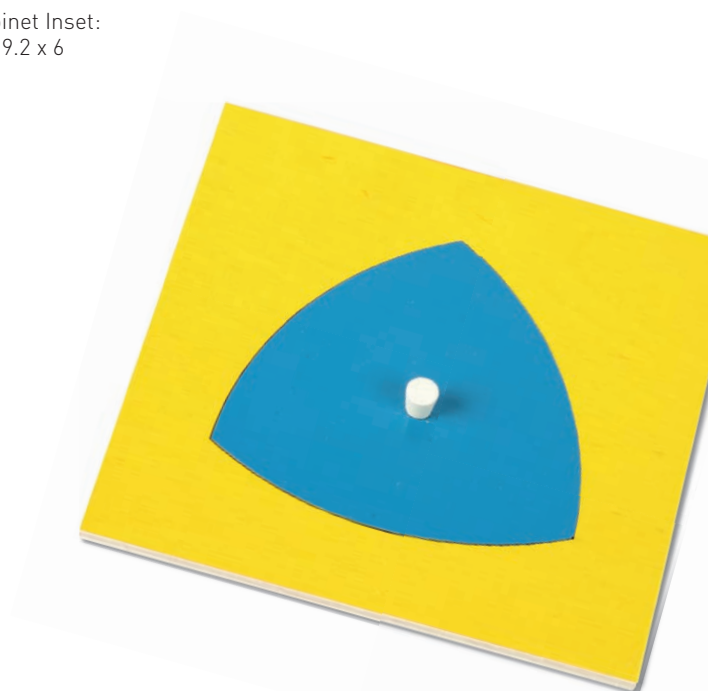



**0.048.00.01**  
Geometric Solids:  
Sphere  
(stand not included)



**0.048.00.04**  
Geometric Solids:  
Cone



**0.048.00.08**  
Geometric Solids:  
Triangular Prism



**0.048.00.02**  
Geometric Solids:  
Ellipsoid  
(stand not included)

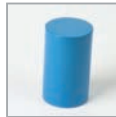

**0.048.00.05**  
Geometric Solids:  
Cylinder



**0.048.00.09**  
Geometric Solids:  
Four Sided Pyramid



**0.048.00.03**  
Geometric Solids:  
Ovoid  
(stand not included)



**0.048.00.06**  
Geometric Solids:  
Cube



**0.048.00.10**  
Geometric Solids:  
Three Sided Pyramid



**0.048.00.07**  
Geometric Solids:  
Four Sided Prism



**0.048.00.11**  
Plastic Stand For  
Geometric Solids (1)

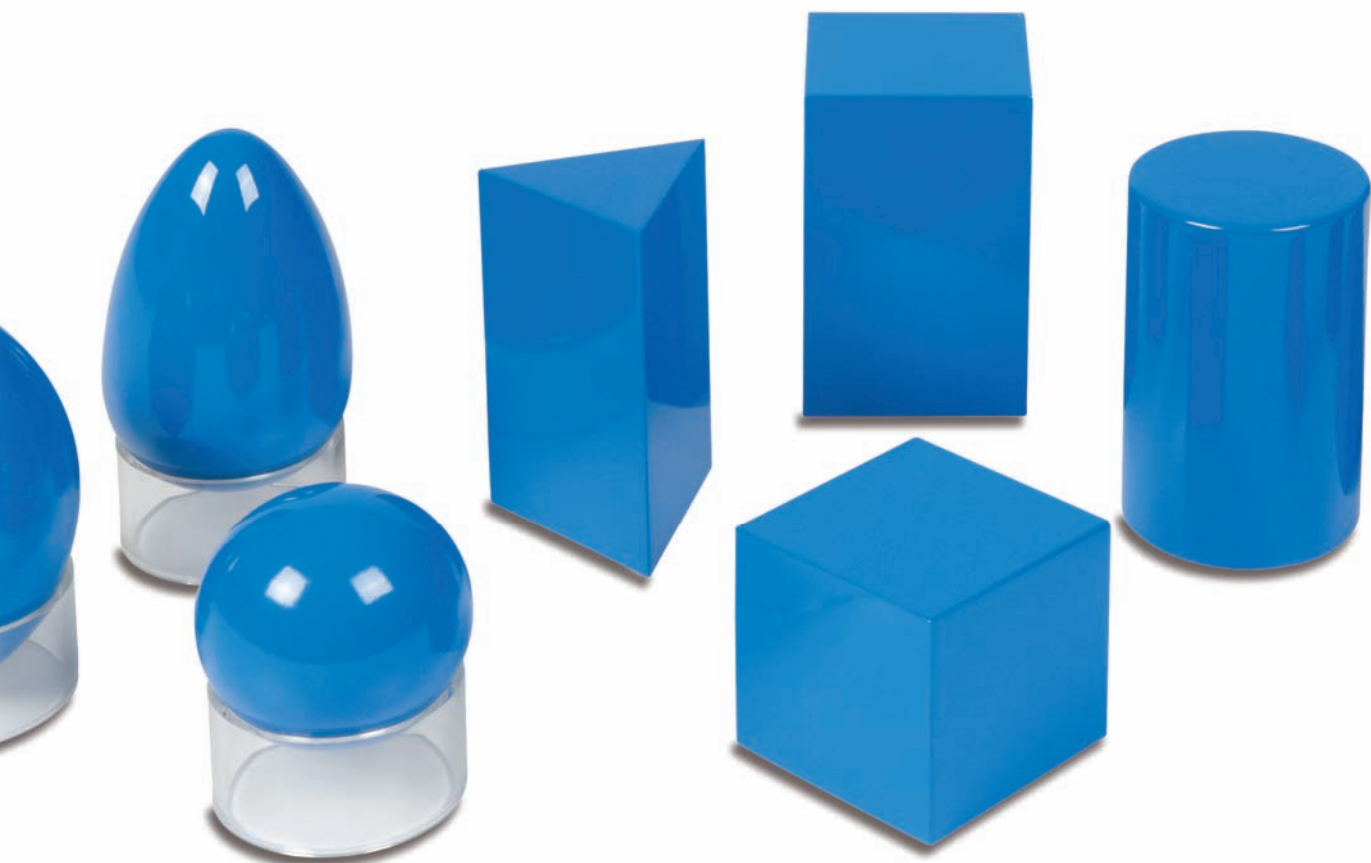

## Sensorial

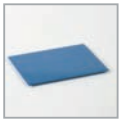

**0.016.00.01**  
Sound Boxes:  
Lid - Blue



**0.016.00.03**  
Sound Cylinder:  
Empty



**0.016.00.04**  
Sound Cylinder:  
Red Top



**0.016.00.02**  
Sound Boxes:  
Lid - Red



**0.016.00.05**  
Sound Cylinder:  
Blue Top





**0.063.A0.01**  
2 Bells Mounted: Low C



**0.063.A0.08**  
2 Bells Mounted: G



**0.063.A0.16**  
Bell Stand: Black



**0.063.A0.02**  
2 Bells Mounted: C Sharp



**0.063.A0.09**  
2 Bells Mounted: G Sharp



**0.063.A0.17**  
Felt Ring For Bells: (1)



**0.063.A0.03**  
2 Bells Mounted: D



**0.063.A0.10**  
2 Bells Mounted: A



**0.063.A0.18**  
Felt Ring For Bells: (26)

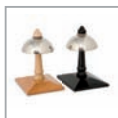

**0.063.A0.04**  
2 Bells Mounted: D Sharp



**0.063.A0.11**  
2 Bells Mounted: B Flat



**0.063.A0.19**  
Knob: Natural Wood  
- Unpainted



**0.063.A0.05**  
2 Bells Mounted: E



**0.063.A0.12**  
2 Bells Mounted: B



**0.063.A0.20**  
Knob: White



**0.063.A0.06**  
2 Bells Mounted: F



**0.063.A0.13**  
2 Bells Mounted: High C



**0.063.A0.21**  
Knob: Black



**0.063.A0.07**  
2 Bells Mounted: F Sharp



**0.063.A0.14**  
Bell Stand: Natural Wood



**0.063.A0.22**  
Knob: Natural Wood



**0.063.A0.15**  
Bell Stand: White



## Language

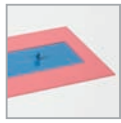

**0.046.00.01**  
Metal Inset:  
Rectangle

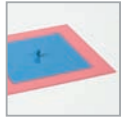

**0.046.00.02**  
Metal Inset:  
Square

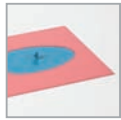

**0.046.00.03**  
Metal Inset:  
Oval

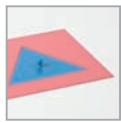

**0.046.00.04**  
Metal Inset:  
Triangle

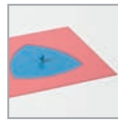

**0.046.00.05**  
Metal Inset:  
Curvilinear Triangle

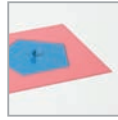

**0.046.00.06**  
Metal Inset:  
Pentagon



**0.046.00.07**  
Metal Inset:  
Quatrefoil

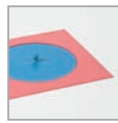

**0.046.00.08**  
Metal Inset:  
Circle

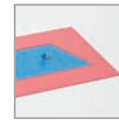

**0.046.00.09**  
Metal Inset:  
Trapezoid

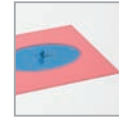

**0.046.00.10**  
Metal Inset:  
Ellipse

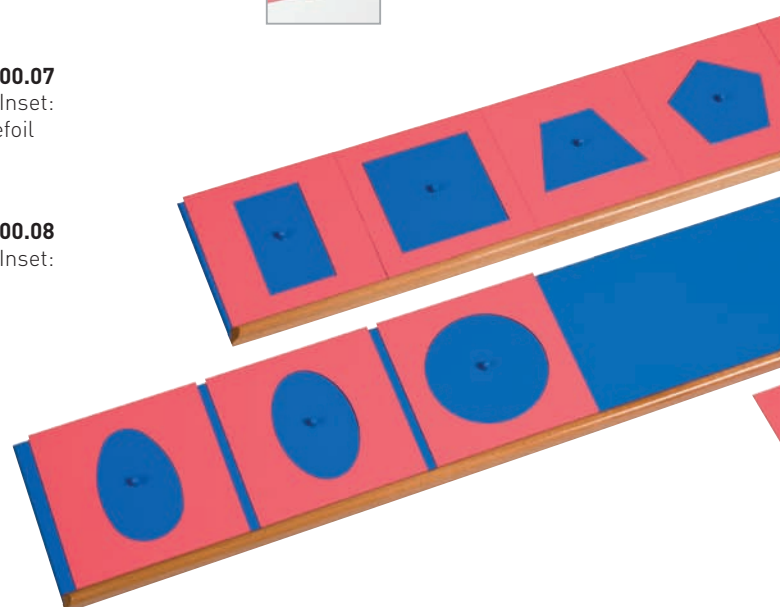

**7.305.00.01**  
Pencil Holder:  
Yellow



**7.305.00.02**  
Pencil Holder:  
Red



**7.305.00.03**  
Pencil Holder:  
Green



**7.305.00.04**  
Pencil Holder:  
Blue



**7.305.00.05**  
Pencil Holder:  
Pink



**7.305.00.06**  
Pencil Holder:  
Black



**7.305.00.07**  
Pencil Holder:  
Gray



**7.305.00.08**  
Pencil Holder:  
Orange



**7.305.00.09**  
Pencil Holder:  
Brown



**7.305.00.10**  
Pencil Holder:  
Purple



**7.305.00.11**  
Pencil Holder:  
White



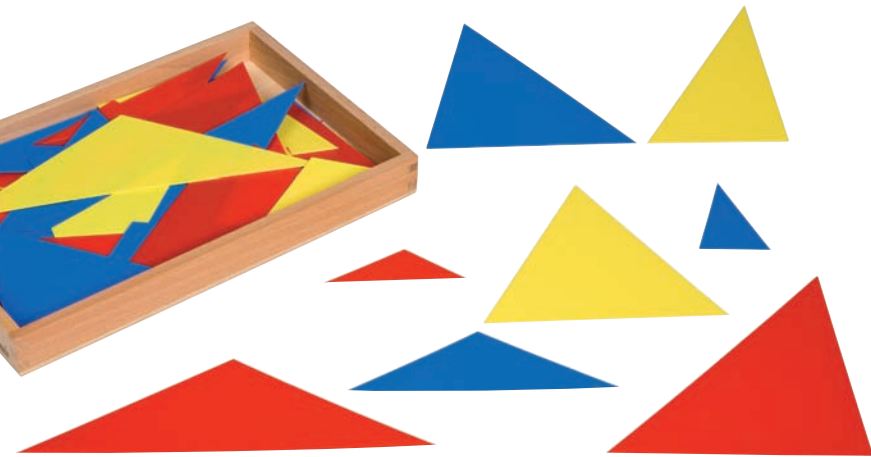

**0.045.A0.01**  
Contents Of Detective  
Adjective Exercise



**0.249.00.01**  
The Farm:  
Farm House



**0.249.00.06**  
The Farm:  
Animals - Mares And Foals



**0.249.00.11**  
The Farm:  
Animals - Big Pigs



**0.249.00.02**  
The Farm:  
Dog House



**0.249.00.07**  
The Farm:  
Animals - Horses



**0.249.00.12**  
The Farm:  
Animals - Sheep

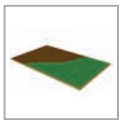

**0.249.00.03**  
The Farm:  
Base Only



**0.249.00.08**  
The Farm:  
Animals - Dutch Cattle



**0.249.00.13**  
The Farm:  
Animals - Farmer Family



**0.249.00.04**  
The Farm:  
Silo



**0.249.00.09**  
The Farm:  
Animals - Jersey Cattle



**0.249.00.14**  
The Farm:  
Animals - Chickens And  
Geese



**0.249.00.05**  
The Farm:  
Set Of Farm Animals



**0.249.00.10**  
The Farm:  
Animals - Dutch Calves

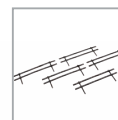

**0.249.00.15**  
The Farm: Fences (5)



## Language

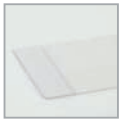

**0.055.00.01**  
Reading Scheme For English:  
Plastic Folders

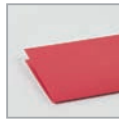

**0.055.00.02**  
Reading Scheme For English:  
Red Folders



**0.108.00.01**  
Reading/Sentence Analysis:  
Arrow - Orange, Unprinted



**0.108.00.06**  
Reading/Sentence Analysis:  
Circle - Black 3.5 cm



**0.108.00.09**  
Reading/Sentence Analysis:  
Triangle - Black



**0.108.00.02**  
Reading/Sentence Analysis:  
Arrow - Black, Unprinted



**0.108.00.07**  
Reading/Sentence Analysis:  
Circle - Black 2.5 cm



**0.108.00.10**  
Reading/Sentence Analysis:  
Triangle - Blue



**0.108.00.03**  
Reading/Sentence Analysis:  
Arrow - Blue, Unprinted



**0.108.00.08**  
Reading/Sentence Analysis:  
Circle - Orange 2.5 cm



**0.108.01.11**  
Reading/Sentence Analysis:  
Large Chart



**0.108.00.04**  
Reading/Sentence Analysis:  
Circle - Red, Unprinted



**0.108.00.05**  
Reading/Sentence Analysis:  
Circle - Black 4.5 cm

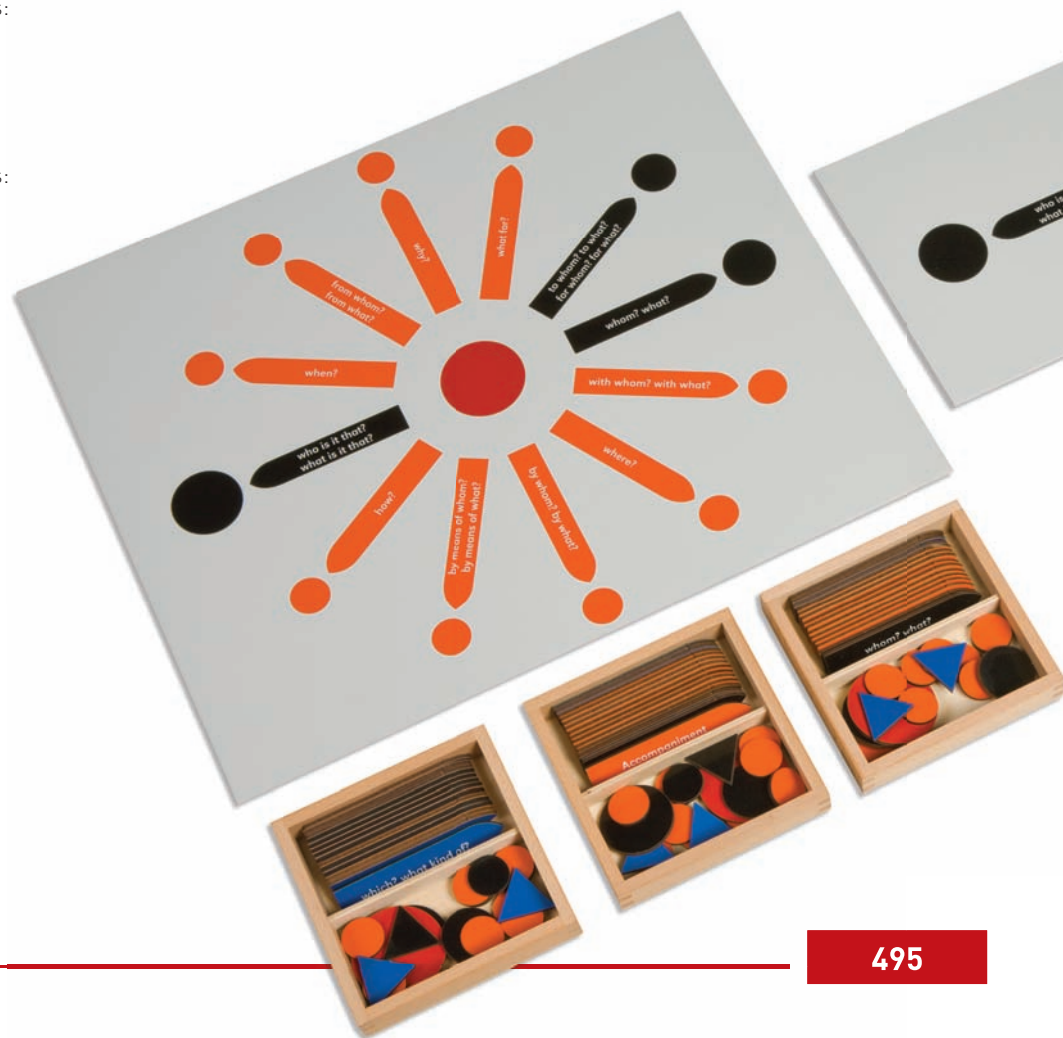





**0.103.00.01**  
Grammar Filling Box:  
Black

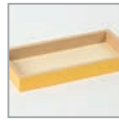

**0.103.00.07**  
Grammar Filling Box:  
Yellow



**0.103.00.13**  
Grammar Filling Box:  
Lid - Purple



**0.103.00.02**  
Grammar Filling Box:  
Brown



**0.103.00.08**  
Grammar Filling Box:  
Blue



**0.103.00.14**  
Grammar Filling Box:  
Lid - Pink



**0.103.00.03**  
Grammar Filling Box:  
Red



**0.103.00.09**  
Grammar Filling Box:  
Gray

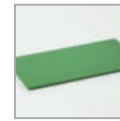

**0.103.00.15**  
Grammar Filling Box:  
Lid - Green



**0.103.00.04**  
Grammar Filling Box:  
Purple



**0.103.00.10**  
Grammar Filling Box:  
Lid - Tan



**0.103.00.16**  
Grammar Filling Box:  
Lid - Yellow



**0.103.00.05**  
Grammar Filling Box:  
Pink



**0.103.00.11**  
Grammar Filling Box:  
Lid - Brown



**0.103.00.17**  
Grammar Filling Box:  
Lid - Blue



**0.103.00.06**  
Grammar Filling Box:  
Green



**0.103.00.12**  
Grammar Filling Box:  
Lid - Red

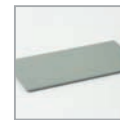

**0.103.00.18**  
Grammar Filling Box:  
Lid - Gray



**0.104.00.01**  
Plastic Folder For  
Command Cards: (1)



**0.104.00.02**  
Plastic Folders For  
Command Cards: (10)



## Mathematics



**0.026.00.01**  
Red Rod And  
Number Rod Prism:  
10 cm

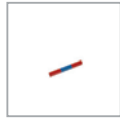

**0.027.00.03**  
Number Rod:  
30 cm



**0.027.00.02**  
Number Rod:  
20 cm

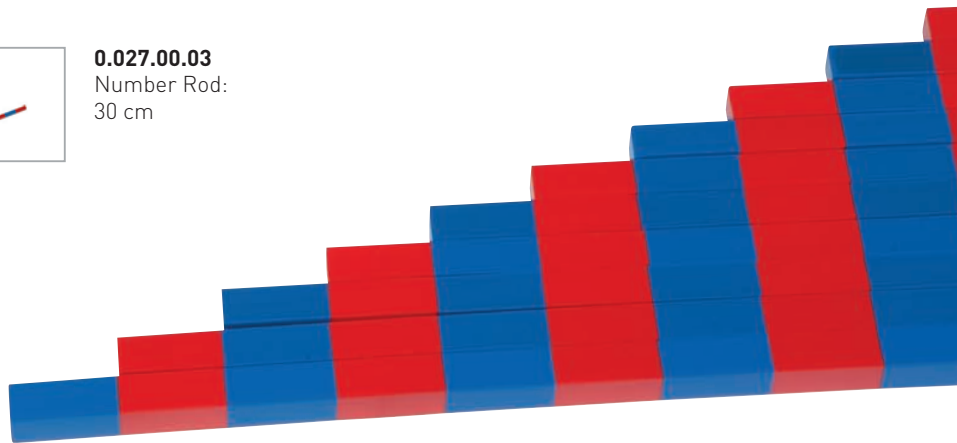

**0.254.00.01**  
Small Numerical Rod:  
2.5 cm



**0.254.00.06**  
Small Numerical Rod:  
15 cm



**0.254.00.02**  
Small Numerical Rod:  
5 cm



**0.254.00.07**  
Small Numerical Rod:  
17.5 cm



**0.254.00.03**  
Small Numerical Rod:  
7.5 cm



**0.254.00.08**  
Small Numerical Rod:  
20 cm



**0.254.00.04**  
Small Numerical Rod:  
10 cm



**0.254.00.09**  
Small Numerical Rod:  
22.5 cm



**0.254.00.05**  
Small Numerical Rod:  
12.5 cm



**0.254.00.10**  
Small Numerical Rod:  
25 cm

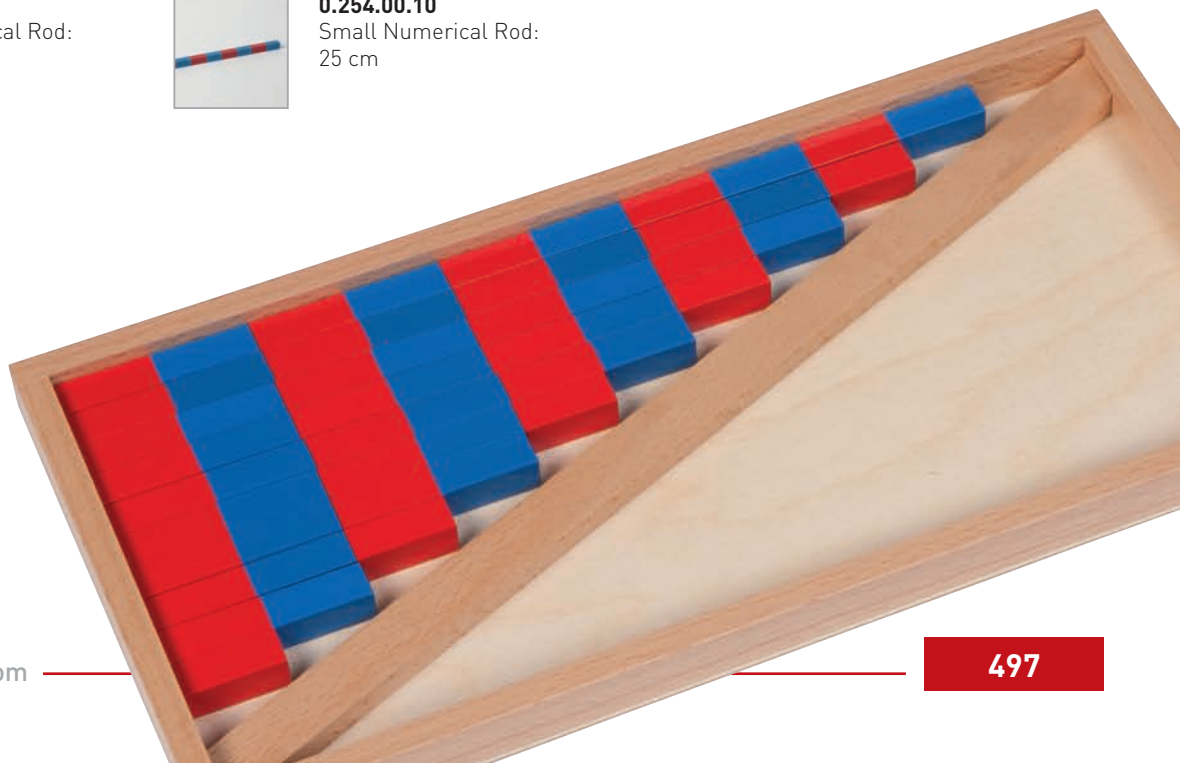



**0.076.00.01**  
Connected Nylon Bar Of 10:  
Gold



**0.076.G0.01**  
Individual Glass Bar Of 10:  
Gold



**0.076.M0.01**  
Individual Nylon Bar Of 10:  
Gold



**0.077.G0.01**  
Individual Glass Bead:  
Gold (With Hole)



**0.077.M0.01**  
Individual Nylon Bead:  
Gold (With Hole)



**0.252.00.01**  
Beechwood Rod  
With 9 Holes

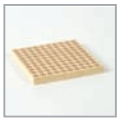

**0.074.00.01**  
Wooden Square Of 100: (1)



**0.075.00.01**  
Wooden Cube Of 1000: (1)

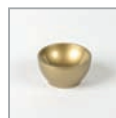
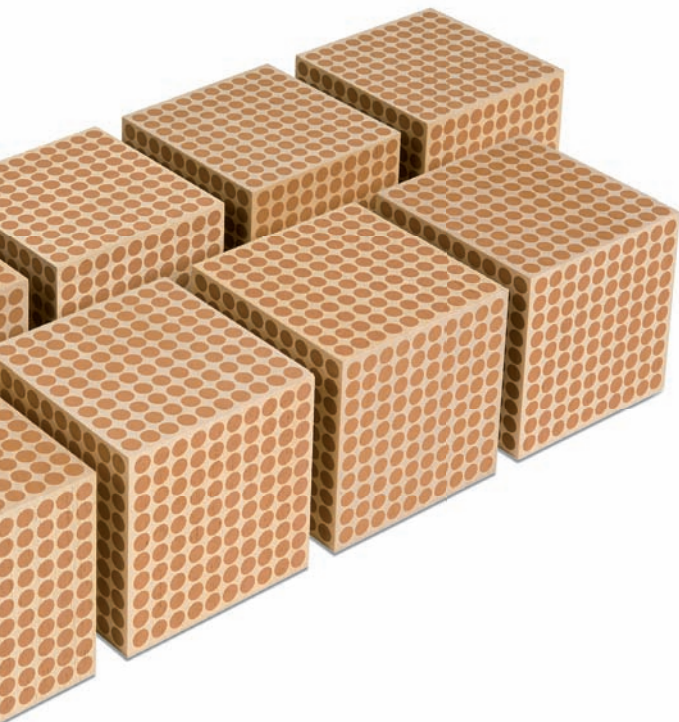

**0.081.00.01**  
Wooden Cup:  
Gold



## Mathematics



**0.082.00.01**  
Stamp Printed With 1



**0.082.00.05**  
Stamp Printed With 100



**0.082.00.02**  
Stamp Printed With 1: (10)



**0.082.00.06**  
Stamp Printed With 100: (10)



**0.082.00.03**  
Stamp Printed With 10



**0.082.00.07**  
Stamp Printed With 1000



**0.082.00.04**  
Stamp Printed With 10: (10)



**0.082.00.08**  
Stamp Printed With 1000: (10)



**0.097.00.01**  
Small Skittle:  
Green



**0.097.00.02**  
Small Skittle:  
Blue



**0.097.00.03**  
Small Skittle:  
Red



**0.098.00.01**  
Large Skittle:  
Green



**0.098.00.02**  
Large Skittle:  
Blue



**0.098.00.03**  
Large Skittle:  
Red



**0.093.00.01**  
Single Wooden  
Bead: Green



**0.093.00.02**  
Single Wooden  
Bead: Blue



**0.093.00.03**  
Single Wooden  
Bead: Red

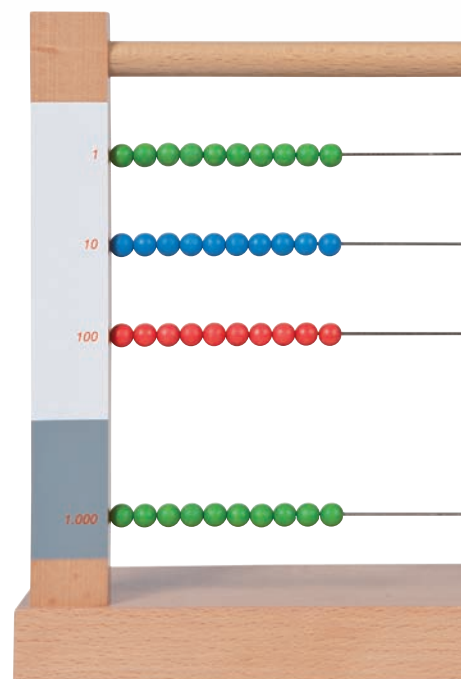



**0.090.00.01**  
Connected Nylon Bead  
Bar Of 1: Red

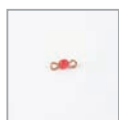

**0.090.G0.01**  
Individual Glass Bead  
Bar Of 1: Red



**0.090.M0.01**  
Individual Nylon Bead  
Bar Of 1: Red



**0.090.00.02**  
Connected Nylon Bead  
Bar Of 2: Green



**0.090.G0.02**  
Individual Glass Bead  
Bar Of 2: Green



**0.090.M0.02**  
Individual Nylon Bead  
Bar Of 2: Green



**0.090.00.03**  
Connected Nylon Bead  
Bar Of 3: Pink



**0.090.G0.03**  
Individual Glass Bead  
Bar Of 3: Pink



**0.090.M0.03**  
Individual Nylon Bead  
Bar Of 3: Pink



**0.090.00.04**  
Connected Nylon Bead  
Bar Of 4: Yellow



**0.090.G0.04**  
Individual Glass Bead  
Bar Of 4: Yellow



**0.090.M0.04**  
Individual Nylon Bead  
Bar Of 4: Yellow



**0.090.00.05**  
Connected Nylon Bead  
Bar Of 5: Light Blue



**0.090.G0.05**  
Individual Glass Bead  
Bar Of 5: Light Blue



**0.090.M0.05**  
Individual Nylon Bead  
Bar Of 5: Light Blue



**0.090.00.06**  
Connected Nylon Bead  
Bar Of 6: Purple



**0.090.G0.06**  
Individual Glass Bead  
Bar Of 6: Purple



**0.090.M0.06**  
Individual Nylon Bead  
Bar Of 6: Purple

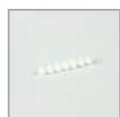

**0.090.00.07**  
Connected Nylon Bead  
Bar Of 7: White

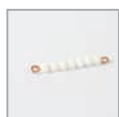

**0.090.G0.07**  
Individual Glass Bead  
Bar Of 7: White



**0.090.M0.07**  
Individual Nylon Bead  
Bar Of 7: White



**0.090.00.08**  
Connected Nylon Bead  
Bar Of 8: Brown



**0.090.G0.08**  
Individual Glass Bead  
Bar Of 8: Brown



**0.090.M0.08**  
Individual Nylon Bead  
Bar Of 8: Brown



**0.090.00.09**  
Connected Nylon Bead  
Bar Of 9: Dark Blue



**0.090.G0.09**  
Individual Glass Bead  
Bar Of 9: Dark Blue



**0.090.M0.09**  
Individual Nylon Bead  
Bar Of 9: Dark Blue



**0.090.00.10**  
Plastic Bridge For  
The Snake Game



## Mathematics

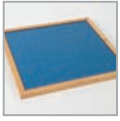

**0.180.00.01**  
Hundred Board:  
Board Only

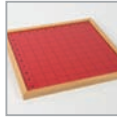

**0.181.00.01**  
Pythagoras Board:  
Board Only



**0.180.00.02**  
Hundred Board:  
Box And Lid With Tiles



**0.181.00.02**  
Pythagoras Board:  
Box And Lid With Tiles



**0.180.00.03**  
Hundred Board:  
Tiles Only



**0.181.00.03**  
Pythagoras Board:  
Tiles Only



**0.180.00.04**  
Hundred/ Pythagoras Board:  
Unprinted Wood Tile

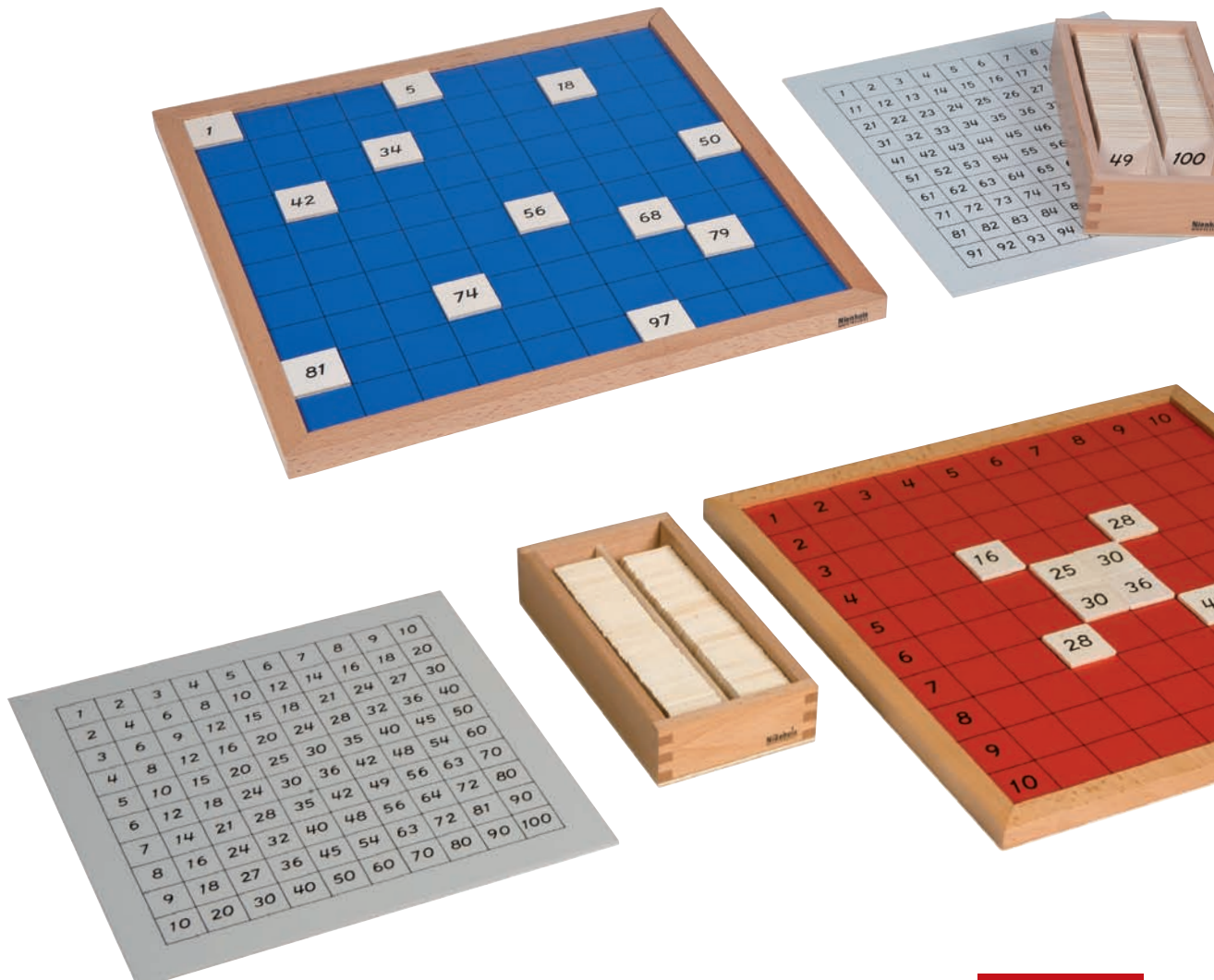



**0.086.00.32**  
Connected Nylon  
Square Of 2:  
Green



**0.086.G0.22**  
Individual Glass  
Bead Square Of 2:  
Green



**0.086.M0.22**  
Individual Nylon  
Bead Square Of 2:  
Green



**0.086.00.33**  
Connected Nylon  
Square Of 3:  
Pink



**0.086.G0.23**  
Individual Glass  
Bead Square Of 3:  
Pink



**0.086.M0.23**  
Individual Nylon  
Bead Square Of 3:  
Pink



**0.086.00.34**  
Connected Nylon  
Square Of 4:  
Yellow



**0.086.G0.24**  
Individual Glass  
Bead Square Of 4:  
Yellow



**0.086.M0.24**  
Individual Nylon  
Bead Square Of 4:  
Yellow



**0.086.00.35**  
Connected Nylon  
Square Of 5:  
Light Blue



**0.086.G0.25**  
Individual Glass  
Bead Square Of 5:  
Light Blue



**0.086.M0.25**  
Individual Nylon  
Bead Square Of 5:  
Light Blue



**0.086.00.36**  
Connected Nylon  
Square Of 6:  
Purple



**0.086.G0.26**  
Individual Glass  
Bead Square Of 6:  
Purple



**0.086.M0.26**  
Individual Nylon  
Bead Square Of 6:  
Purple



**0.086.00.37**  
Connected Nylon  
Square Of 7:  
White



**0.086.G0.27**  
Individual Glass  
Bead Square Of 7:  
White



**0.086.M0.27**  
Individual Nylon  
Bead Square Of 7:  
White



**0.086.00.38**  
Connected Nylon  
Square Of 8:  
Brown



**0.086.G0.28**  
Individual Glass  
Bead Square Of 8:  
Brown



**0.086.M0.28**  
Individual Nylon  
Bead Square Of 8:  
Brown

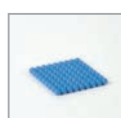

**0.086.00.39**  
Connected Nylon  
Square Of 9:  
Dark Blue



**0.086.G0.29**  
Individual Glass  
Bead Square Of 9:  
Dark Blue



**0.086.M0.29**  
Individual Nylon  
Bead Square Of 9:  
Dark Blue

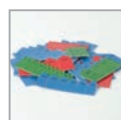

**0.079.00.11**  
Arrows Only  
100/1000 Chains



**0.086.00.41**  
Plastic Box For  
Arrows: Small



**0.086.00.43**  
Plastic Box For  
Arrows: Large



**0.080.00.01**  
Arrows Only For  
Short Chains

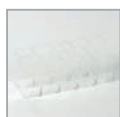

**0.086.00.42**  
Plastic Box For  
Arrows: Small (10)



**0.086.00.44**  
Plastic Box For  
Arrows: Large (10)



**0.086.00.40**  
Printed Arrows For  
Long Bead Chains



## Mathematics



**0.086.00.22**  
Connected Nylon  
Bead Cube Of 2:  
Green



**0.086.00.23**  
Connected Nylon  
Bead Cube Of 3:  
Pink



**0.086.00.24**  
Connected Nylon  
Bead Cube Of 4:  
Yellow



**0.086.00.25**  
Connected Nylon  
Bead Cube Of 5:  
Light Blue



**0.086.00.26**  
Connected Nylon  
Bead Cube Of 6:  
Purple



**0.086.00.27**  
Connected Nylon  
Bead Cube Of 7:  
White



**0.086.00.28**  
Connected Nylon  
Bead Cube Of 8:  
Brown

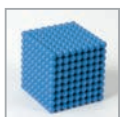

**0.086.00.29**  
Connected Nylon  
Bead Cube Of 9:  
Dark Blue



**0.086.G0.32**  
Individual Glass  
Bead Cube Of 2:  
Green



**0.086.G0.33**  
Individual Glass  
Bead Cube Of 3:  
Pink



**0.086.G0.34**  
Individual Glass  
Bead Cube Of 4:  
Yellow



**0.086.G0.35**  
Individual Glass  
Bead Cube Of 5:  
Light Blue



**0.086.G0.36**  
Individual Glass  
Bead Cube Of 6:  
Purple



**0.086.G0.37**  
Individual Glass  
Bead Cube Of 7:  
White



**0.086.G0.38**  
Individual Glass  
Bead Cube Of 8:  
Brown

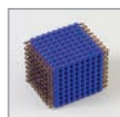

**0.086.G0.39**  
Individual Glass  
Bead Cube Of 9:  
Dark Blue



**0.086.M0.32**  
Individual Nylon  
Bead Cube Of 2:  
Green



**0.086.M0.33**  
Individual Nylon  
Bead Cube Of 3:  
Pink



**0.086.M0.34**  
Individual Nylon  
Bead Cube Of 4:  
Yellow



**0.086.M0.35**  
Individual Nylon  
Bead Cube Of 5:  
Light Blue



**0.086.M0.36**  
Individual Nylon  
Bead Cube Of 6:  
Purple



**0.086.M0.37**  
Individual Nylon  
Bead Cube Of 7:  
White



**0.086.M0.38**  
Individual Nylon  
Bead Cube Of 8:  
Brown

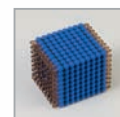

**0.086.M0.39**  
Individual Nylon  
Bead Cube Of 9:  
Dark Blue



**0.086.00.45**  
S-Hooks For Chains:  
Copper (1)



**0.086.00.46**  
S-Hooks For Chains:  
Copper (10)



**0.086.00.47**  
O-Rings For Chains:  
Copper (1)



**0.086.00.48**  
O-Rings For Chains:  
Copper (10)





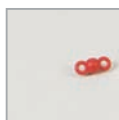

**0.086.00.01**  
Connected Nylon  
Short Bead Chain Of 1:  
Red



**0.086.00.02**  
Connected Nylon  
Short Bead Chain Of 2:  
Green



**0.086.00.03**  
Connected Nylon  
Short Bead Chain Of 3:  
Pink



**0.086.00.04**  
Connected Nylon  
Short Bead Chain Of 4:  
Yellow



**0.086.00.05**  
Connected Nylon  
Short Bead Chain Of 5:  
Light Blue

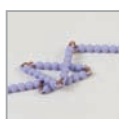

**0.086.00.06**  
Connected Nylon  
Short Bead Chain Of 6:  
Purple



**0.086.00.07**  
Connected Nylon  
Short Bead Chain Of 7:  
White



**0.086.00.08**  
Connected Nylon  
Short Bead Chain Of 8:  
Brown



**0.086.00.09**  
Connected Nylon  
Short Bead Chain Of 9:  
Dark Blue



**0.086.G0.02**  
Individual Glass  
Short Bead Chain Of 2:  
Green



**0.086.G0.03**  
Individual Glass  
Short Bead Chain Of 3:  
Pink



**0.086.G0.04**  
Individual Glass  
Short Bead Chain Of 4:  
Yellow



**0.086.G0.05**  
Individual Glass  
Short Bead Chain Of 5:  
Light Blue



**0.086.G0.06**  
Individual Glass  
Short Bead Chain Of 6:  
Purple



**0.086.G0.07**  
Individual Glass  
Short Bead Chain Of 7:  
White



**0.086.G0.08**  
Individual Glass  
Short Bead Chain Of 8:  
Brown



**0.086.G0.09**  
Individual Glass  
Short Bead Chain Of 9:  
Dark Blue



**0.086.M0.02**  
Individual Nylon  
Short Bead Chain Of 2:  
Green



**0.086.M0.03**  
Individual Nylon  
Short Bead Chain Of 3:  
Pink



**0.086.M0.04**  
Individual Nylon  
Short Bead Chain Of 4:  
Yellow



**0.086.M0.05**  
Individual Nylon  
Short Bead Chain Of 5:  
Light Blue



**0.086.M0.06**  
Individual Nylon  
Short Bead Chain Of 6:  
Purple



**0.086.M0.07**  
Individual Nylon  
Short Bead Chain Of 7:  
White



**0.086.M0.08**  
Individual Nylon  
Short Bead Chain Of 8:  
Brown



**0.086.M0.09**  
Individual Nylon  
Short Bead Chain Of 9:  
Dark Blue

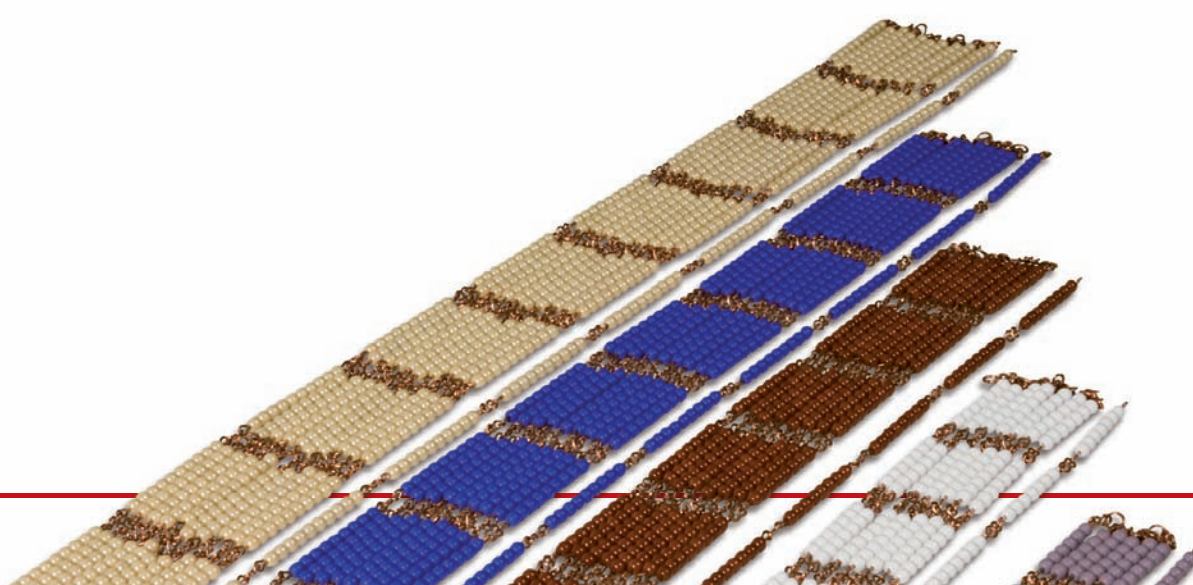

## Mathematics



**0.086.00.12**  
Connected Nylon  
Long Bead Chain Of 2:  
Green



**0.086.G0.12**  
Individual Glass  
Long Bead Chain Of 2:  
Green



**0.086.M0.12**  
Individual Nylon  
Long Bead Chain Of 2:  
Green



**0.086.00.13**  
Connected Nylon  
Long Bead Chain Of 3:  
Pink



**0.086.G0.13**  
Individual Glass  
Long Bead Chain Of 3:  
Pink



**0.086.M0.13**  
Individual Nylon  
Long Bead Chain Of 3:  
Pink



**0.086.00.14**  
Connected Nylon  
Long Bead Chain Of 4:  
Yellow

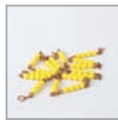

**0.086.G0.14**  
Individual Glass  
Long Bead Chain Of 4:  
Yellow



**0.086.M0.14**  
Individual Nylon  
Long Bead Chain Of 4:  
Yellow



**0.086.00.15**  
Connected Nylon  
Long Bead Chain Of 5:  
Light Blue



**0.086.G0.15**  
Individual Glass  
Long Bead Chain Of 5:  
Light Blue



**0.086.M0.15**  
Individual Nylon  
Long Bead Chain Of 5:  
Light Blue



**0.086.00.16**  
Connected Nylon  
Long Bead Chain Of 6:  
Purple



**0.086.G0.16**  
Individual Glass  
Long Bead Chain Of 6:  
Purple



**0.086.M0.16**  
Individual Nylon  
Long Bead Chain Of 6:  
Purple



**0.086.00.17**  
Connected Nylon  
Long Bead Chain Of 7:  
White



**0.086.G0.17**  
Individual Glass  
Long Bead Chain Of 7:  
White



**0.086.M0.17**  
Individual Nylon  
Long Bead Chain Of 7:  
White



**0.086.00.18**  
Connected Nylon  
Long Bead Chain Of 8:  
Brown



**0.086.G0.18**  
Individual Glass  
Long Bead Chain Of 8:  
Brown



**0.086.M0.18**  
Individual Nylon  
Long Bead Chain Of 8:  
Brown



**0.086.00.19**  
Connected Nylon  
Long Bead Chain Of 9:  
Dark Blue



**0.086.G0.19**  
Individual Glass  
Long Bead Chain Of 9:  
Dark Blue



**0.086.M0.19**  
Individual Nylon  
Long Bead Chain Of 9:  
Dark Blue

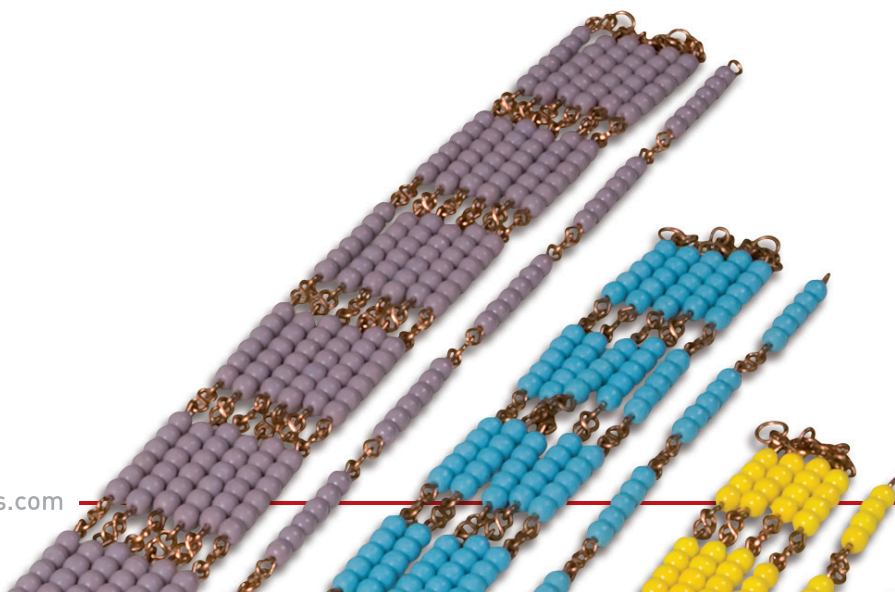



**0.291.00.01**  
Solid Nylon Bead:  
Light Gray



**0.291.G0.01**  
Individual Glass Bead  
Bar Of 1:  
Light Gray



**0.291.M0.01**  
Individual Nylon Bead  
Bar Of 1:  
Light Gray



**0.291.00.02**  
Connected Nylon Bead  
Bar Of 2:  
Light Gray



**0.291.G0.02**  
Individual Glass Bead  
Bar Of 2:  
Light Gray



**0.291.M0.02**  
Individual Nylon Bead  
Bar Of 2:  
Light Gray



**0.291.00.03**  
Connected Nylon Bead  
Bar Of 3:  
Light Gray



**0.291.G0.03**  
Individual Glass Bead  
Bar Of 3:  
Light Gray



**0.291.M0.03**  
Individual Nylon Bead  
Bar Of 3:  
Light Gray



**0.291.00.04**  
Connected Nylon Bead  
Bar Of 4:  
Light Gray



**0.291.G0.04**  
Individual Glass Bead  
Bar Of 4:  
Light Gray



**0.291.M0.04**  
Individual Nylon Bead  
Bar Of 4:  
Light Gray



**0.291.00.05**  
Connected Nylon Bead  
Bar Of 5:  
Light Gray



**0.291.G0.05**  
Individual Glass Bead  
Bar Of 5:  
Light Gray



**0.291.M0.05**  
Individual Nylon Bead  
Bar Of 5:  
Light Gray



**0.291.00.06**  
Connected Nylon Bead  
Bar Of 6:  
Light And Dark Gray



**0.291.G0.06**  
Individual Glass Bead  
Bar Of 6:  
Light And Dark Gray



**0.291.M0.06**  
Individual Nylon Bead  
Bar Of 6:  
Light And Dark Gray



**0.291.00.07**  
Connected Nylon Bead  
Bar Of 7:  
Light And Dark Gray



**0.291.G0.07**  
Individual Glass Bead  
Bar Of 7:  
Light And Dark Gray



**0.291.M0.07**  
Individual Nylon Bead  
Bar Of 7:  
Light And Dark Gray



**0.291.00.08**  
Connected Nylon Bead  
Bar Of 8:  
Light And Dark Gray



**0.291.G0.08**  
Individual Glass Bead  
Bar Of 8:  
Light And Dark Gray



**0.291.M0.08**  
Individual Nylon Bead  
Bar Of 8:  
Light And Dark Gray



**0.291.00.09**  
Connected Nylon Bead  
Bar Of 9:  
Light And Dark Gray



**0.291.G0.09**  
Individual Glass Bead  
Bar Of 9:  
Light And Dark Gray



**0.291.M0.09**  
Individual Nylon Bead  
Bar Of 9:  
Light And Dark Gray



## Mathematics



**0.091.00.01**  
Connected Nylon  
Bead Bar Of 1:  
Black



**0.091.00.02**  
Connected Nylon  
Bead Bar Of 2:  
Black



**0.091.00.03**  
Connected Nylon  
Bead Bar Of 3:  
Black



**0.091.00.04**  
Connected Nylon  
Bead Bar Of 4:  
Black



**0.091.00.05**  
Connected Nylon  
Bead Bar Of 5:  
Black



**0.091.00.06**  
Connected Nylon  
Bead Bar Of 6:  
Black And White



**0.091.00.07**  
Connected Nylon  
Bead Bar Of 7:  
Black And White



**0.091.00.08**  
Connected Nylon  
Bead Bar Of 8:  
Black And White



**0.091.00.09**  
Connected Nylon  
Bead Bar Of 9:  
Black And White



**0.091.G0.01**  
Individual Glass  
Bead Bar Of 1:  
Black



**0.091.G0.02**  
Individual Glass  
Bead Bar Of 2:  
Black



**0.091.G0.03**  
Individual Glass  
Bead Bar Of 3:  
Black



**0.091.G0.04**  
Individual Glass  
Bead Bar Of 4:  
Black



**0.091.G0.05**  
Individual Glass  
Bead Bar Of 5:  
Black



**0.091.G0.06**  
Individual Glass  
Bead Bar Of 6:  
Black And White



**0.091.G0.07**  
Individual Glass  
Bead Bar Of 7:  
Black And White



**0.091.G0.08**  
Individual Glass  
Bead Bar Of 8:  
Black And White



**0.091.G0.09**  
Individual Glass  
Bead Bar Of 9:  
Black And White



**0.091.G0.10**  
Individual Glass  
Bead: Black  
(With Hole)



**0.091.M0.01**  
Individual Nylon  
Bead Bar Of 1:  
Black



**0.091.M0.02**  
Individual Nylon  
Bead Bar Of 2:  
Black



**0.091.M0.03**  
Individual Nylon  
Bead Bar Of 3:  
Black



**0.091.M0.04**  
Individual Nylon  
Bead Bar Of 4:  
Black



**0.091.M0.05**  
Individual Nylon  
Bead Bar Of 5:  
Black



**0.091.M0.06**  
Individual Nylon  
Bead Bar Of 6:  
Black And White



**0.091.M0.07**  
Individual Nylon  
Bead Bar Of 7:  
Black And White



**0.091.M0.08**  
Individual Nylon  
Bead Bar Of 8:  
Black And White



**0.091.M0.09**  
Individual Nylon  
Bead Bar Of 9:  
Black And White





**0.292.00.01**  
Solid Nylon Bead Of 1:  
White



**0.292.G0.01**  
Individual Glass Bead  
Bar Of 1:  
White



**0.292.M0.01**  
Individual Nylon Bead  
Bar Of 1:  
White



**0.292.00.02**  
Connected Nylon Bead  
Bar Of 2:  
White



**0.292.G0.02**  
Individual Glass Bead  
Bar Of 2:  
White



**0.292.M0.02**  
Individual Nylon Bead  
Bar Of 2:  
White



**0.292.00.03**  
Connected Nylon Bead  
Bar Of 3:  
White



**0.292.G0.03**  
Individual Glass Bead  
Bar Of 3:  
White



**0.292.M0.03**  
Individual Nylon Bead  
Bar Of 3:  
White



**0.292.00.04**  
Connected Nylon Bead  
Bar Of 4:  
White



**0.292.G0.04**  
Individual Glass Bead  
Bar Of 4:  
White



**0.292.M0.04**  
Individual Nylon Bead  
Bar Of 4:  
White

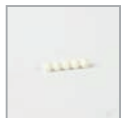

**0.292.00.05**  
Connected Nylon Bead  
Bar Of 5:  
White



**0.292.G0.05**  
Individual Glass Bead  
Bar Of 5:  
White



**0.292.M0.05**  
Individual Nylon Bead  
Bar Of 5:  
White



**0.292.00.06**  
Connected Nylon Bead  
Bar Of 6:  
Red And White



**0.292.G0.06**  
Individual Glass Bead  
Bar Of 6:  
Red And White



**0.292.M0.06**  
Individual Nylon Bead  
Bar Of 6:  
Red And White



**0.292.00.07**  
Connected Nylon Bead  
Bar Of 7:  
Red And White



**0.292.G0.07**  
Individual Glass Bead  
Bar Of 7:  
Red And White



**0.292.M0.07**  
Individual Nylon Bead  
Bar Of 7:  
Red And White



**0.292.00.08**  
Connected Nylon Bead  
Bar Of 8:  
Red And White



**0.292.G0.08**  
Individual Glass Bead  
Bar Of 8:  
Red And White



**0.292.M0.08**  
Individual Nylon Bead  
Bar Of 8:  
Red And White



**0.292.00.09**  
Connected Nylon Bead  
Bar Of 9:  
Red And White



**0.292.G0.09**  
Individual Glass Bead  
Bar Of 9:  
Red And White



**0.292.M0.09**  
Individual Nylon Bead  
Bar Of 9:  
Red And White



**0.292.00.10**  
Connected Nylon Bead  
Bar Of 10:  
Light Gray



**0.292.G0.10**  
Individual Glass Bead  
Bar Of 10:  
Light Gray



**0.292.M0.10**  
Individual Nylon Bead  
Bar Of 10:  
Light Gray



## Mathematics



**0.132.A0.01**  
Hierarchy Of Numbers:  
Green Cube -  
0.5 x 0.5 x 0.5

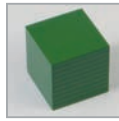

**0.132.A0.04**  
Hierarchy Of Numbers:  
Green Cube -  
5 x 5 x 5



**0.132.A0.07**  
Hierarchy Of Numbers:  
Tray For Small Pieces



**0.132.A0.02**  
Hierarchy Of Numbers:  
Blue Bar -  
5 x 0.5 x 0.5

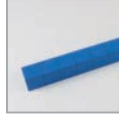

**0.132.A0.05**  
Hierarchy Of Numbers:  
Blue Bar -  
50 x 5 x 5

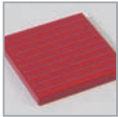

**0.132.A0.03**  
Hierarchy Of Numbers:  
Red Tablet -  
5 x 5 x 0.5

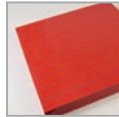

**0.132.A0.06**  
Hierarchy Of Numbers:  
Red Tablet -  
50 x 50 x 5



**0.095.00.01**  
Long Division Tube:  
Plastic (1)



**0.095.00.02**  
Long Division Tube:  
Plastic (10)



**0.095.00.03**  
Wooden Cup:  
White / Green



**0.095.00.06**  
Wooden Cup:  
Gray / Green



**0.095.00.04**  
Wooden Cup:  
White / Blue



**0.095.00.07**  
Wooden Cup:  
Gray / Blue



**0.095.00.05**  
Wooden Cup:  
White / Red



**0.095.00.08**  
Wooden Cup:  
Gray / Red



**0.095.00.09**  
Wooden Cup:  
Black / Green



**0.095.00.13**  
Long Division Board:  
Blue



**0.096.A0.01**  
Long Division / Unit  
Division Board:  
Green



**0.095.00.14**  
Long Division Board:  
Red



**0.096.A0.02**  
Box With 9  
Small Skittles:  
Green



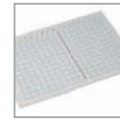
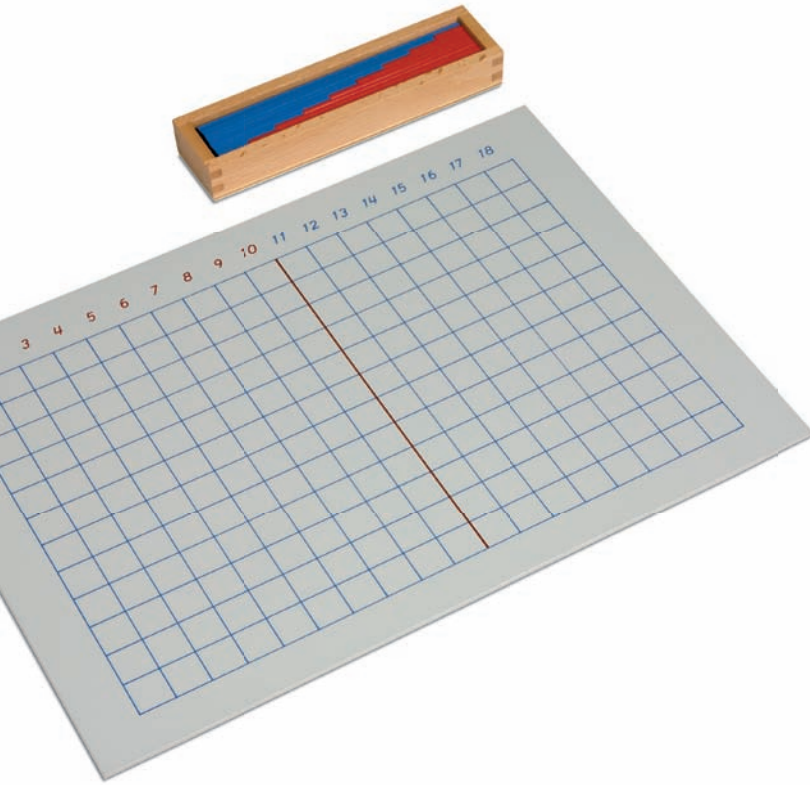

**0.092.00.01**  
Addition Strip Board:  
Board Only

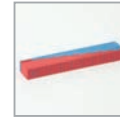

**0.092.00.02**  
Addition/Subtraction  
Strip Board:  
Set Of Colored Strips



**0.092.00.03**  
Addition/Subtraction  
Strip Board:  
Box With Colored Strips



**0.092.00.04**  
Addition/Subtraction  
Strip Board: First 2 Strips  
- Red/Blue/Natural

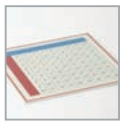

**0.142.A0.01**  
Addition Working Charts:  
Full Chart



**0.142.A0.03**  
Addition Working Charts:  
Skip Chart



**0.142.A0.06**  
Addition Working Charts:  
Control Chart Half

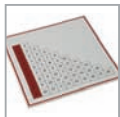

**0.142.A0.02**  
Addition Working Charts:  
Half Chart

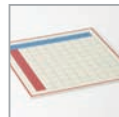

**0.142.A0.04**  
Addition Working Charts:  
Blind Chart



**0.142.A0.07**  
Addition Working Charts:  
Box With Addition Chips



**0.142.A0.05**  
Addition Working Charts:  
Control Chart Full



**0.142.A0.08**  
Addition Working Charts:  
Addition Chips

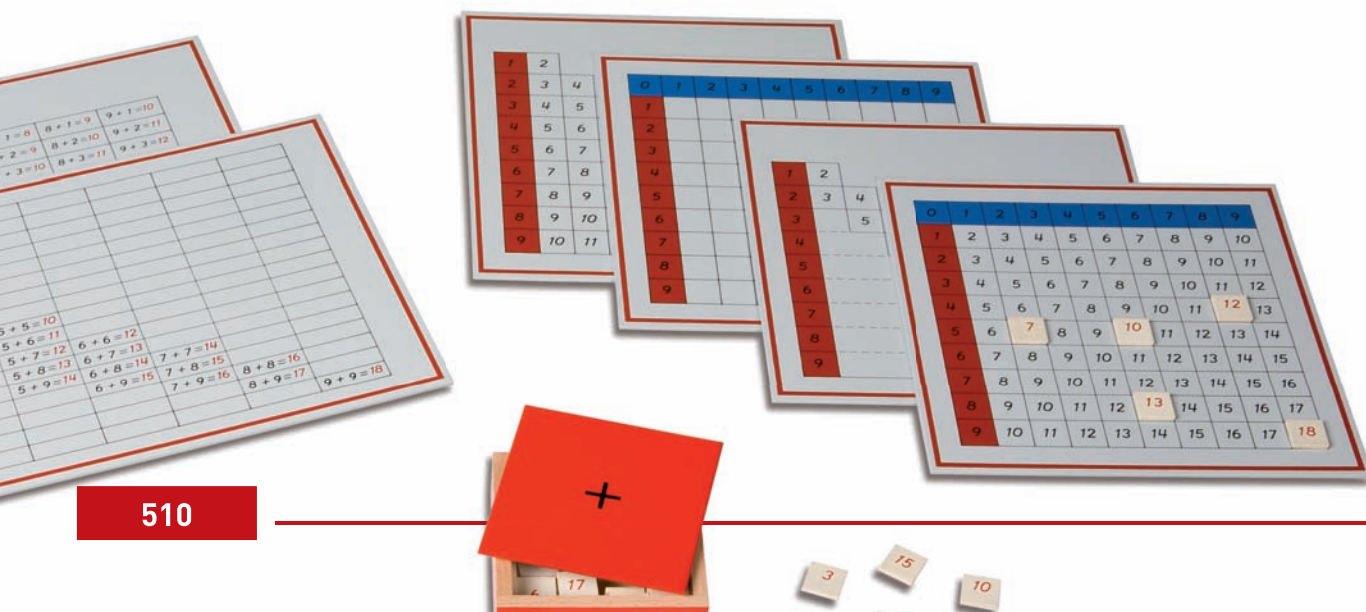

## Mathematics

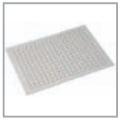

**0.092.00.05**  
Subtraction Strip Board:  
Board Only



**0.092.00.06**  
Subtraction Strip Board:  
Set Of Natural  
Colored Strips



**0.092.00.07**  
Subtraction Strip Board:  
Box With Natural  
Colored Strips

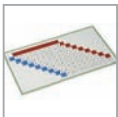
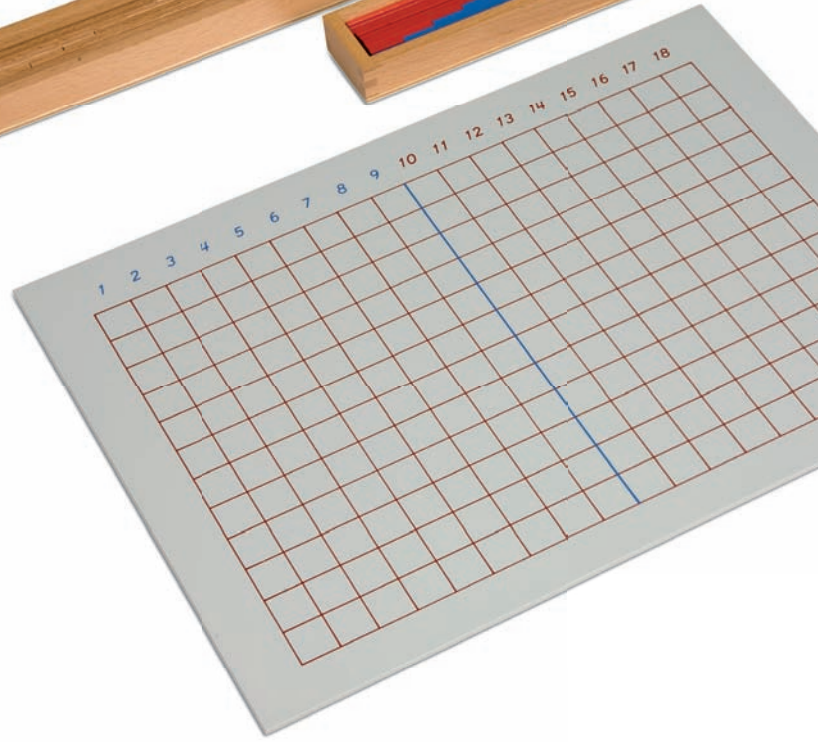
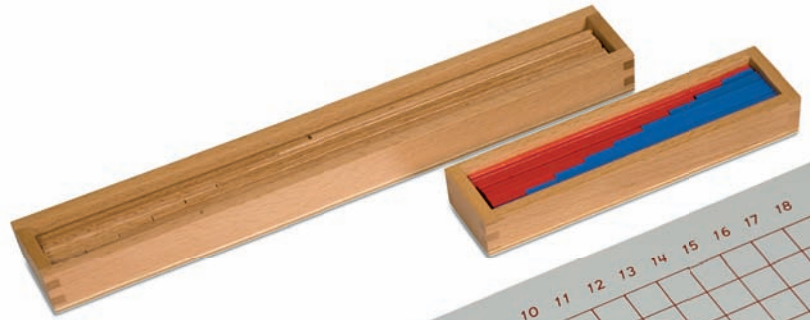

**0.142.B0.01**  
Subtraction Working Charts:  
Full Chart



**0.142.B0.03**  
Subtraction Working Charts:  
Control Chart Full



**0.142.B0.05**  
Subtraction Working Charts:  
Subtraction Chips

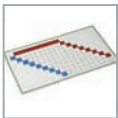

**0.142.B0.02**  
Subtraction Working Charts:  
Blind Chart



**0.142.B0.04**  
Subtraction Working Charts:  
Box With Subtraction Chips

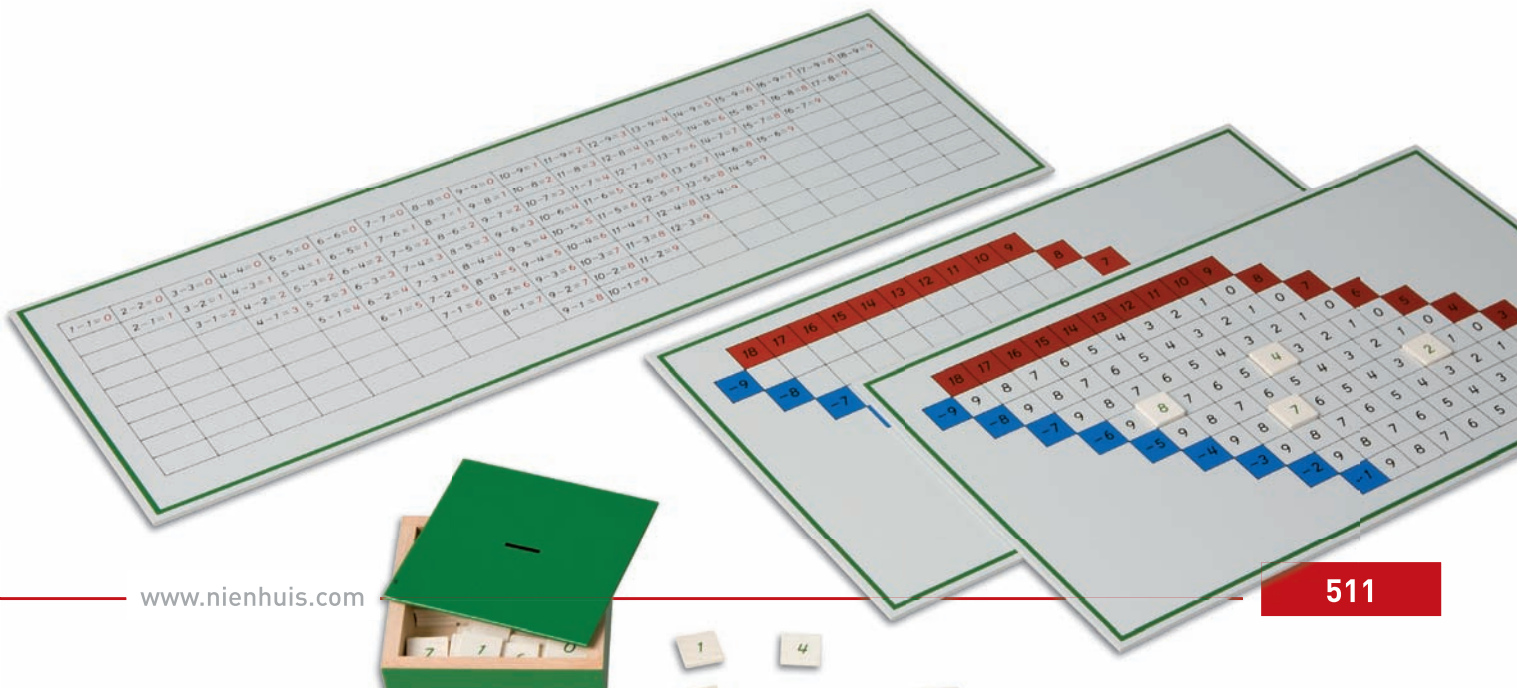



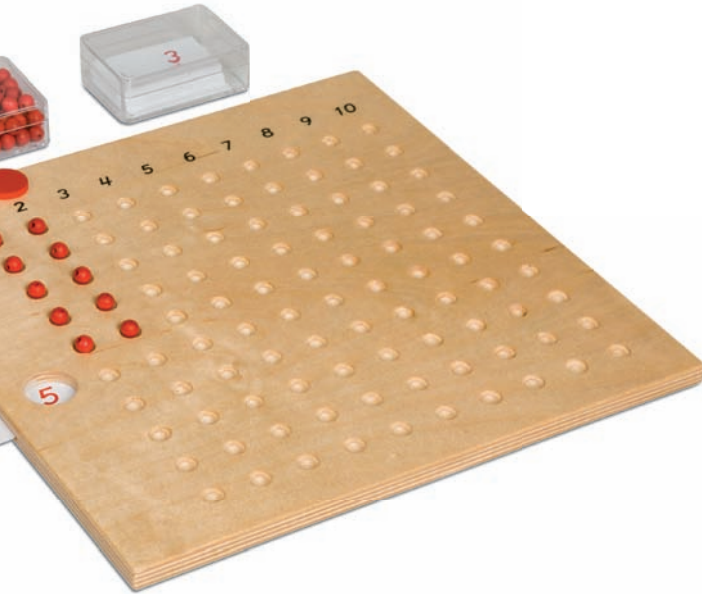

**0.087.00.01**  
Numbers Only For  
Multiplication Board

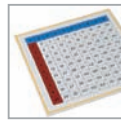

**0.142.C4.01**  
Multiplication Working Charts:  
Full Chart



**0.142.C4.05**  
Multiplication Working Charts:  
Control Chart Half



**0.142.C4.02**  
Multiplication Working Charts:  
Half Chart



**0.142.C4.06**  
Multiplication Working Charts:  
Box With Multiplication Chips

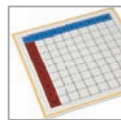

**0.142.C4.03**  
Multiplication Working Charts:  
Blind Chart



**0.142.C4.07**  
Multiplication Working Charts:  
Multiplication Chips



**0.142.C4.04**  
Multiplication Working Charts:  
Control Chart Full

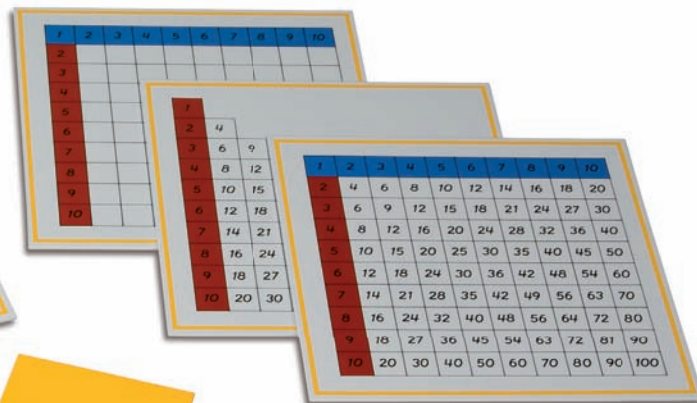
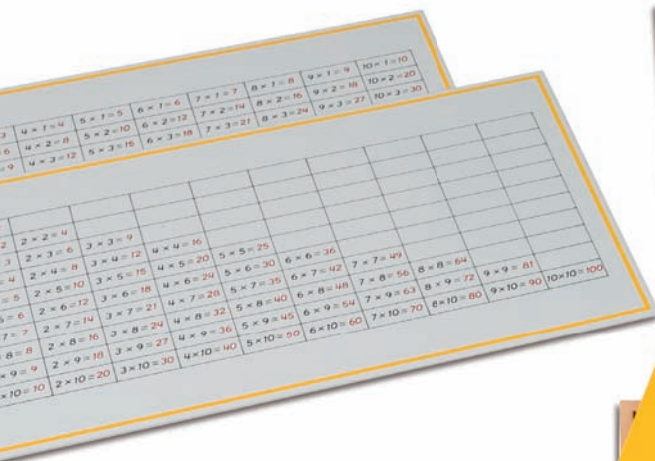

## Mathematics

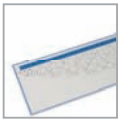

**0.142.D1.01**  
Division Working Charts:  
Full Chart



**0.142.D1.04**  
Division Working Charts:  
Division Chips



**0.142.D1.02**  
Division Working Charts:  
Blind Chart



**0.142.D1.03**  
Division Working Charts:  
Box With Division Chips

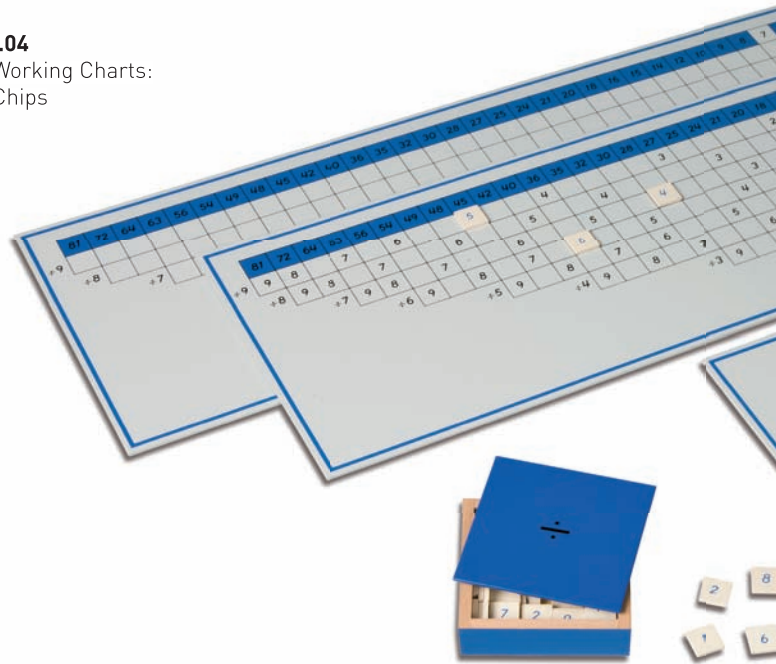

**0.129.00.01**  
Power Of Three:  
Yellow Cube -  
 $3 \times 3 \times 3$



**0.129.00.02**  
Power Of Three:  
White Prism -  
 $3 \times 3 \times 9$



**0.130.00.01**  
Power Of Two Cube:  
Empty Box



**0.130.00.05**  
Power Of Two:  
Yellow Cube -  
 $4 \times 4 \times 4$



**0.130.00.02**  
Power Of Two/  
Trinomial:  
Yellow Cube -  
 $2 \times 2 \times 2$



**0.130.00.06**  
Power Of Two:  
White Prism -  
 $8 \times 4 \times 4$



**0.130.00.03**  
Power Of Two:  
White Prism -  
 $4 \times 2 \times 2$



**0.130.00.07**  
Power Of Two:  
Green Prism -  
 $4 \times 8 \times 8$



**0.130.00.04**  
Power Of Two:  
Green Prism -  
 $2 \times 4 \times 4$

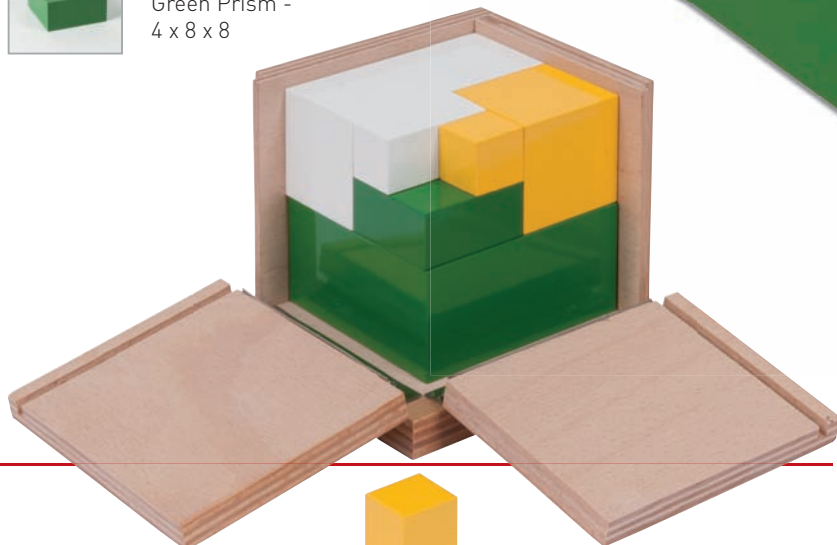
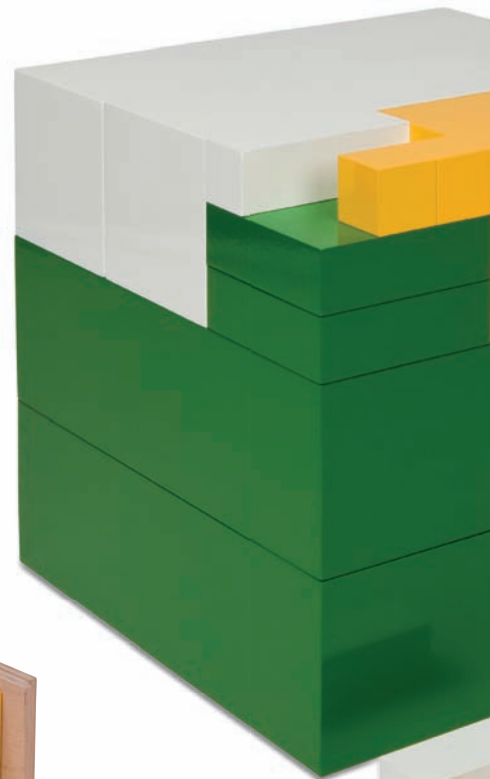



**0.131.00.01**  
Binomial Cube Box:  
Decal



**0.131.00.04**  
Binomial/Trinomial Cube:  
Blue -  
 $3 \times 3 \times 3$

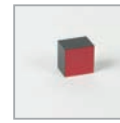

**0.131.00.06**  
Binomial/Trinomial Cube:  
Black And Red Prism -  
 $3 \times 4 \times 4$



**0.131.00.02**  
Binomial Cube Box:  
Empty

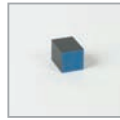

**0.131.00.05**  
Binomial/Trinomial Cube:  
Black And Blue Prism -  
 $4 \times 3 \times 3$



**0.131.00.07**  
Binomial/Trinomial Cube:  
Red -  
 $4 \times 4 \times 4$



**0.131.00.03**  
Binomial Cube Box:  
Lid



**0.132.00.01**  
Trinomial Cube Box:  
Decal

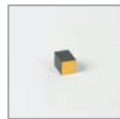

**0.132.00.04**  
Trinomial Cube:  
Black And Yellow Prism -  
 $3 \times 2 \times 2$



**0.132.00.07**  
Trinomial Cube:  
Black And Blue Prism -  
 $2 \times 3 \times 3$



**0.132.00.02**  
Trinomial Cube Box:  
Empty



**0.132.00.05**  
Trinomial Cube:  
Black And Yellow Prism -  
 $4 \times 2 \times 2$



**0.132.00.08**  
Trinomial Cube:  
Black And Red Prism -  
 $2 \times 4 \times 4$



**0.132.00.03**  
Trinomial Cube Box:  
Lid

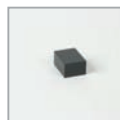

**0.132.00.06**  
Trinomial Cube:  
Black Prism -  
 $4 \times 3 \times 2$

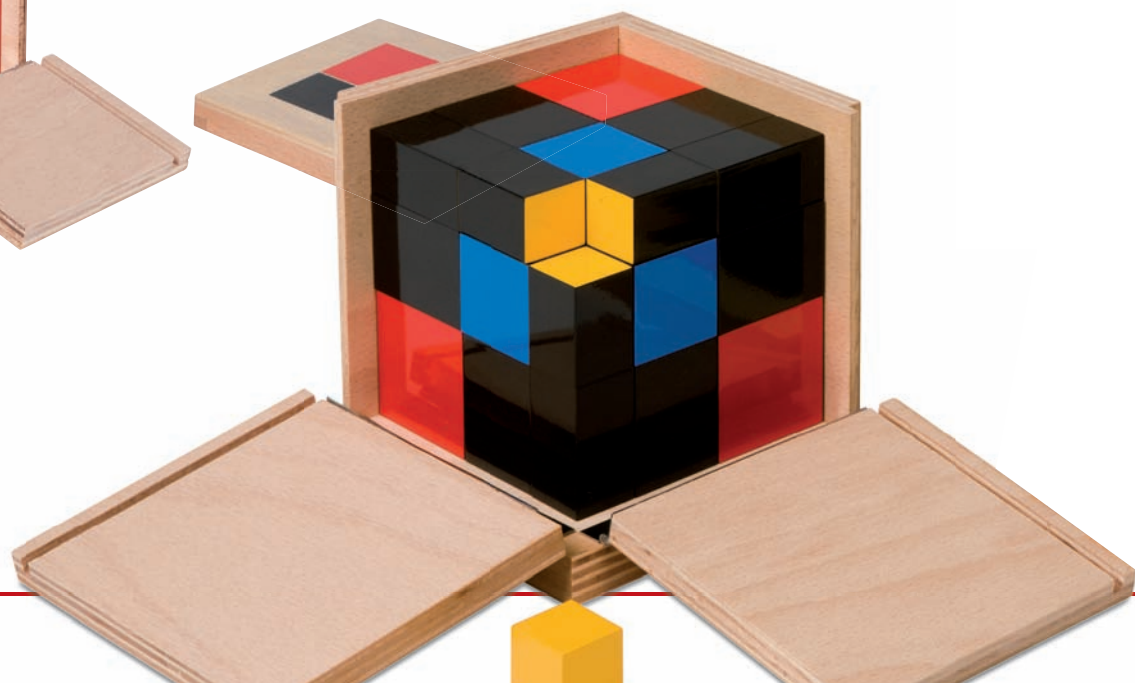
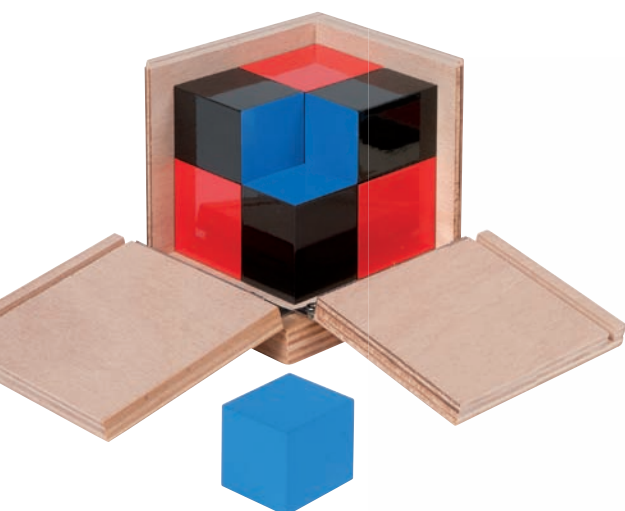

## Mathematics

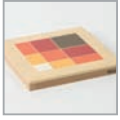

**0.187.00.01**  
Arithmetic Trinomial  
Cube Box:  
Lid



**0.187.00.05**  
Arithmetic Trinomial Cube:  
Red Prism -  
 $4 \times 3 \times 2$



**0.187.00.09**  
Arithmetic Trinomial Cube:  
Brown Prism -  
 $2 \times 4 \times 4$



**0.187.00.02**  
Arithmetic Trinomial Cube:  
White Cube -  
 $2 \times 2 \times 2$



**0.187.00.06**  
Arithmetic Trinomial Cube:  
Orange Prism -  
 $2 \times 3 \times 3$



**0.187.00.10**  
Arithmetic Trinomial Cube:  
Light Green Prism -  
 $3 \times 4 \times 4$



**0.187.00.03**  
Arithmetic Trinomial Cube:  
Yellow Prism -  
 $3 \times 2 \times 2$



**0.187.00.07**  
Arithmetic Trinomial Cube:  
Red Cube -  
 $3 \times 3 \times 3$



**0.187.00.11**  
Arithmetic Trinomial Cube:  
Blue Cube -  
 $4 \times 4 \times 4$



**0.187.00.04**  
Arithmetic Trinomial Cube:  
Orange Prism -  
 $4 \times 2 \times 2$



**0.187.00.08**  
Arithmetic Trinomial Cube:  
Brown Prism -  
 $4 \times 3 \times 3$

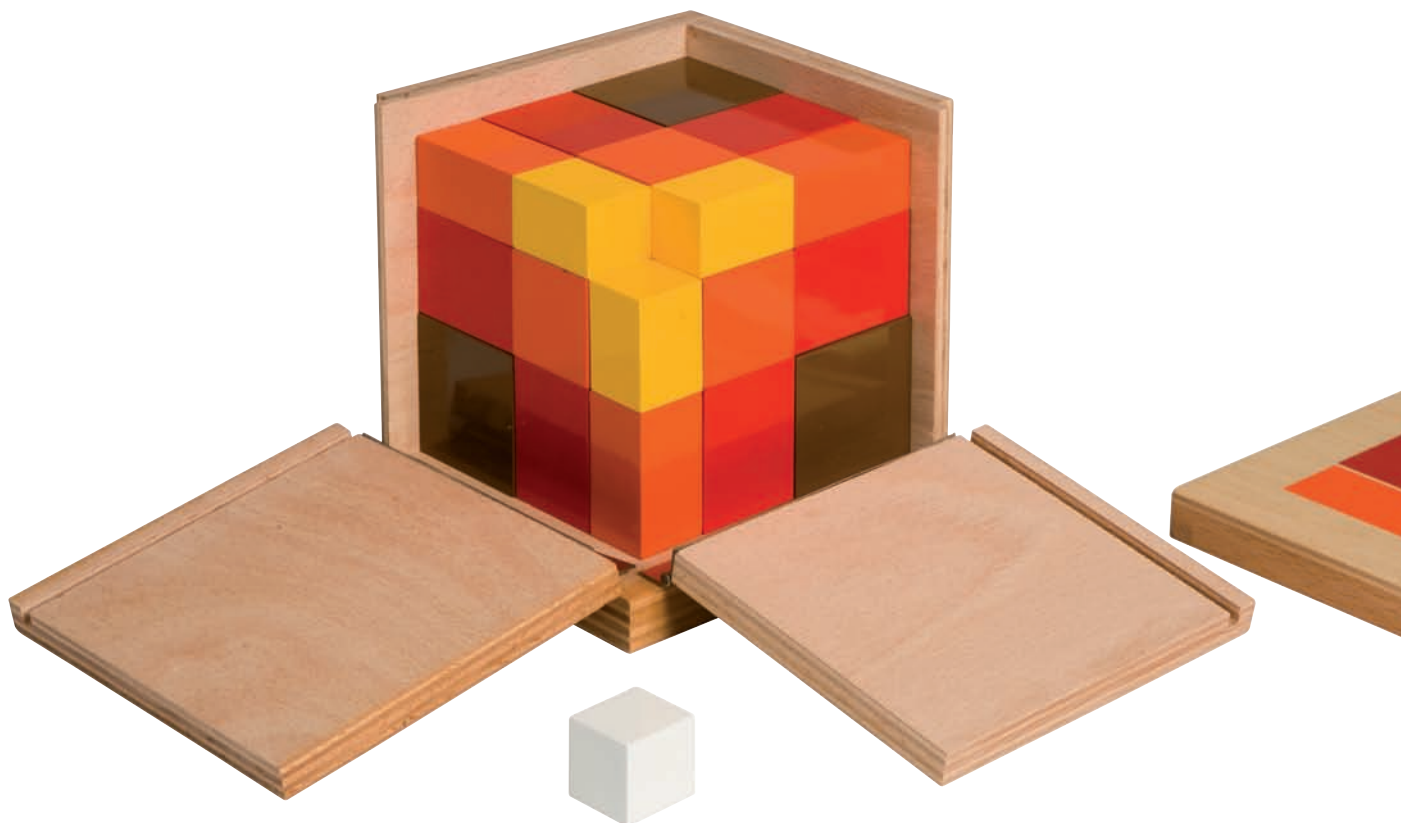



**0.189.00.01**  
Cubing Material:  
Red Cube -  
1 x 1 x 1

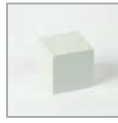

**0.189.00.07**  
Cubing Material:  
White Cube -  
7 x 7 x 7



**0.189.00.13**  
Cubing Material:  
Yellow Square -  
4 x 4 x 1



**0.189.00.02**  
Cubing Material:  
Green Cube -  
2 x 2 x 2



**0.189.00.08**  
Cubing Material:  
Brown Cube -  
8 x 8 x 8



**0.189.00.14**  
Cubing Material:  
Light Blue Square -  
5 x 5 x 1



**0.189.00.03**  
Cubing Material:  
Pink Cube -  
3 x 3 x 3



**0.189.00.09**  
Cubing Material:  
Dark Blue Cube -  
9 x 9 x 9



**0.189.00.15**  
Cubing Material:  
Purple Square -  
6 x 6 x 1



**0.189.00.04**  
Cubing Material:  
Yellow Cube -  
4 x 4 x 4



**0.189.00.10**  
Cubing Material:  
Red Square -  
1 x 1 x 1



**0.189.00.16**  
Cubing Material:  
White Square -  
7 x 7 x 1



**0.189.00.05**  
Cubing Material:  
Light Blue Cube -  
5 x 5 x 5



**0.189.00.11**  
Cubing Material:  
Green Square -  
2 x 2 x 1

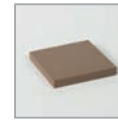

**0.189.00.17**  
Cubing Material:  
Brown Square -  
8 x 8 x 1



**0.189.00.06**  
Cubing Material:  
Purple Cube -  
6 x 6 x 6



**0.189.00.12**  
Cubing Material:  
Pink Square -  
3 x 3 x 1

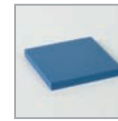

**0.189.00.18**  
Cubing Material:  
Dark Blue Square -  
9 x 9 x 1



## Mathematics



**0.186.00.01**  
Table Of Pythagoras:  
Contents Only



**0.138.B0.01**  
Number Tiles:  
Contents Only



**0.185.00.01**  
Cut-Out Labeled  
Fraction Circles:  
Contents Only



**0.095.00.10**  
Wooden Cup:  
Green



**0.095.00.11**  
Wooden Cup:  
Red



**0.095.00.12**  
Wooden Cup:  
Blue



**3.429.00.02**  
Wooden Peg:  
Red (10)



**3.429.00.04**  
Wooden Peg:  
Green (10)



**3.429.00.06**  
Wooden Peg:  
Blue (10)

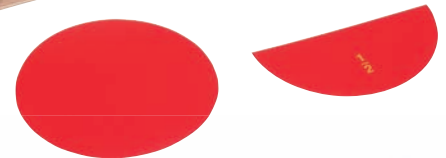



**0.073.00.01**  
Contents Of  
The Bank Game



**0.113.00.01**  
Large Fraction Skittle:  
Whole



**0.113.00.03**  
Large Fraction Skittle:  
Three Thirds



**0.113.00.02**  
Large Fraction Skittle:  
Two Halves



**0.113.00.04**  
Large Fraction Skittle:  
Four Fourths



**0.188.A0.01**  
Volume Box:  
White-wash Cube -  
2 x 2 x 2



**0.192.00.01**  
Volume Box:  
White-wash Cube -  
1 x 1 x 1



**0.192.00.02**  
Volume Box:  
White-wash Cube -  
1 x 1 x 1 (10)

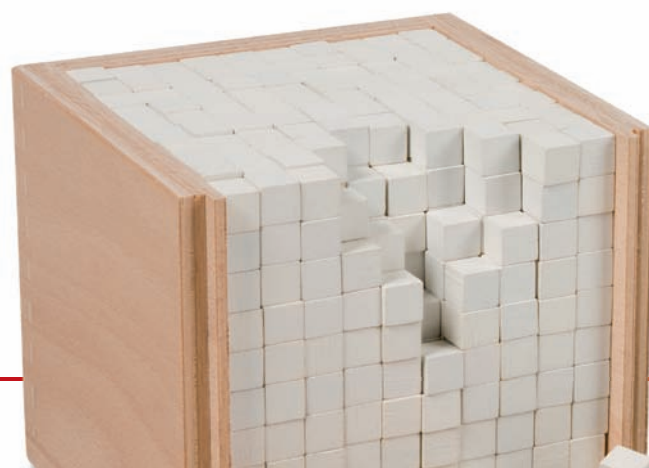

## Mathematics



**0.270.00.01**  
Multibase:  
Round Number Cards

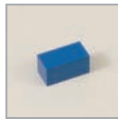

**0.270.00.06**  
Multibase:  
Blue Prism -  
 $2 \times 2 \times 4$



**0.270.00.10**  
Multibase:  
Red Prism -  
 $4 \times 4 \times 2$



**0.270.00.02**  
Multibase:  
Green Cube -  
 $1 \times 1 \times 1$



**0.270.00.07**  
Multibase:  
Red Prism -  
 $3 \times 3 \times 1$



**0.270.00.11**  
Multibase:  
Green Cube -  
 $4 \times 4 \times 4$



**0.270.00.03**  
Multibase:  
Blue Prism -  
 $1 \times 1 \times 2$



**0.270.00.08**  
Multibase:  
Green Cube -  
 $3 \times 3 \times 3$



**0.270.00.12**  
Multibase:  
Red Prism -  
 $3 \times 9 \times 9$



**0.270.00.04**  
Multibase:  
Red Prism -  
 $2 \times 2 \times 1$

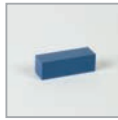

**0.270.00.09**  
Multibase:  
Blue Prism -  
 $3 \times 3 \times 9$



**0.270.00.13**  
Multibase:  
Green Cube -  
 $9 \times 9 \times 9$



**0.270.00.05**  
Multibase:  
Green Cube -  
 $2 \times 2 \times 2$

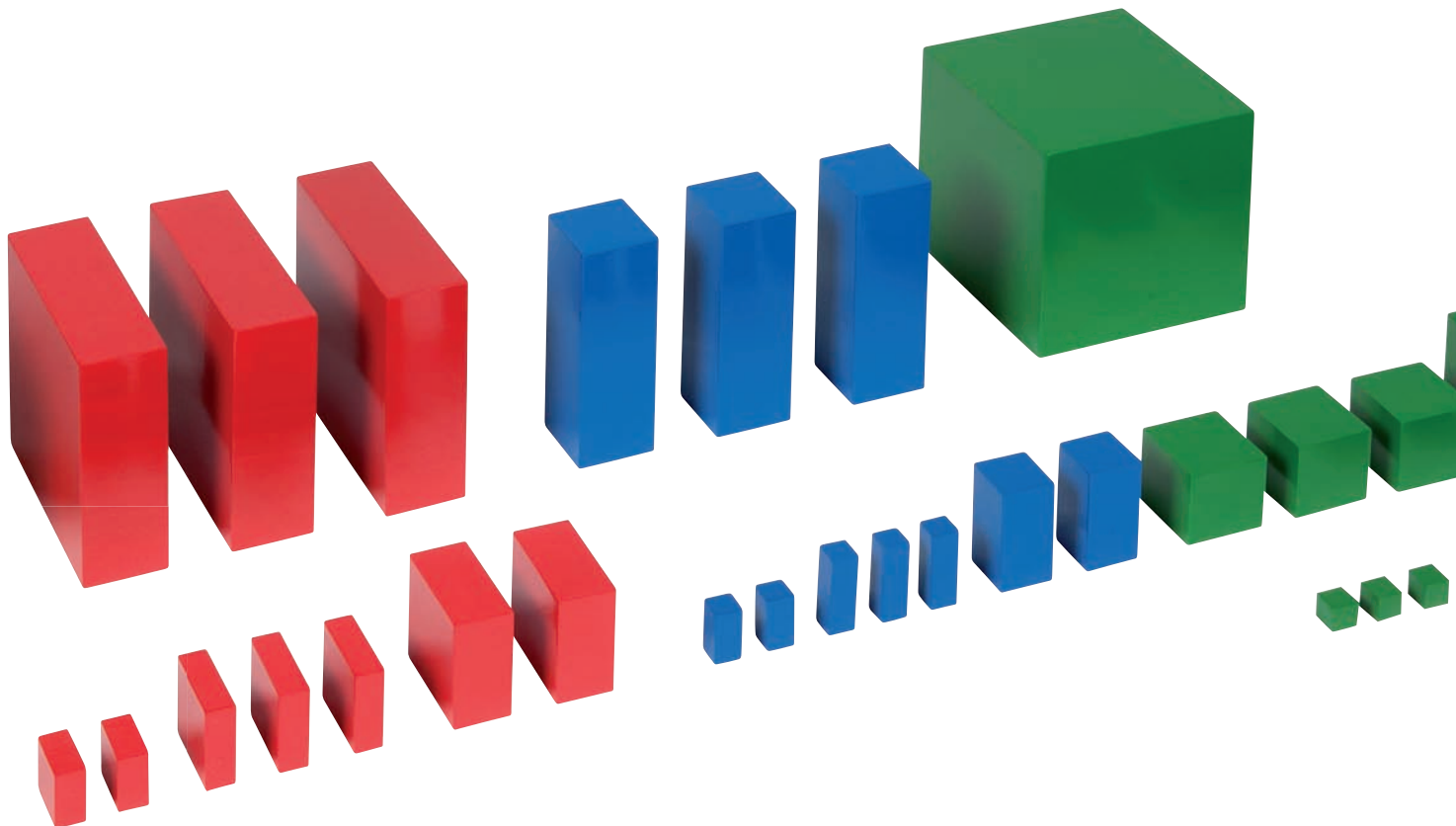



**Biology**



**0.041.00.01**  
Contents Of The  
Botany Cabinet  
(drawers not included)



**0.041.00.07**  
Botany Cabinet Inset:  
Spatulate



**0.041.00.13**  
Botany Cabinet Inset:  
Linear



**0.041.00.02**  
Botany Cabinet Inset:  
Acerose



**0.041.00.08**  
Botany Cabinet Inset:  
Deltoid

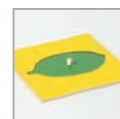

**0.041.00.14**  
Botany Cabinet Inset:  
Elliptical

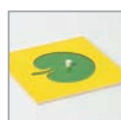

**0.041.00.03**  
Botany Cabinet Inset:  
Reniform



**0.041.00.09**  
Botany Cabinet Inset:  
Ovate



**0.041.00.15**  
Botany Cabinet Inset:  
Hastate



**0.041.00.04**  
Botany Cabinet Inset:  
Sagittate



**0.041.00.10**  
Botany Cabinet Inset:  
Lanceolate



**0.041.00.16**  
Botany Cabinet Inset:  
Fan-shaped



**0.041.00.05**  
Botany Cabinet Inset:  
Orbiculate



**0.041.00.11**  
Botany Cabinet Inset:  
Obcordate



**0.041.00.17**  
Botany Cabinet Inset:  
Cuneate



**0.041.00.06**  
Botany Cabinet Inset:  
Cordate

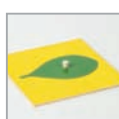

**0.041.00.12**  
Botany Cabinet Inset:  
Obovate



**0.041.00.18**  
Botany Cabinet Inset:  
Oblong



**0.041.00.19**  
Botany Cabinet Inset:  
Peltate

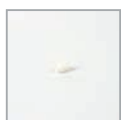

**0.037.00.03**  
White Knobs:  
For Maps/Insets/  
Puzzles



**0.195.00.01**  
Plastic Folder For  
Botany Cards (1)



**0.037.00.04**  
White Knobs:  
For Maps/Insets/  
Puzzles (10)



**0.037.00.05**  
White Knobs:  
For Maps/Insets/  
Puzzles (25)



## Biology



**0.198.00.04**  
Botany Puzzle Piece:  
Leaf - Stipule



**0.198.00.13**  
Botany Puzzle Piece:  
Tree - Branch Lower  
Left



**0.198.00.21**  
Botany Puzzle Piece:  
Tree - Leaves Lower  
Right



**0.198.00.05**  
Botany Puzzle Piece:  
Leaf - Stem



**0.198.00.14**  
Botany Puzzle Piece:  
Tree - Branch Upper  
Left



**0.198.00.22**  
Botany Puzzle Piece:  
Flower - Calyx



**0.198.00.06**  
Botany Puzzle Piece:  
Leaf - Vein Lower Part



**0.198.00.15**  
Botany Puzzle Piece:  
Tree - Top Branches



**0.198.00.23**  
Botany Puzzle Piece:  
Flower - Crown Lower  
Left



**0.198.00.07**  
Botany Puzzle Piece:  
Leaf - Vein Upper Part



**0.198.00.16**  
Botany Puzzle Piece:  
Tree - Branches Right



**0.198.00.24**  
Botany Puzzle Piece:  
Flower - Crown Upper  
Left



**0.198.00.08**  
Botany Puzzle Piece:  
Leaf - Lamina: Left



**0.198.00.17**  
Botany Puzzle Piece:  
Tree - Leaves Lower  
Left



**0.198.00.25**  
Botany Puzzle Piece:  
Flower - Stamen



**0.198.00.09**  
Botany Puzzle Piece:  
Leaf - Lamina: Top



**0.198.00.18**  
Botany Puzzle Piece:  
Tree - Leaves Upper  
Left



**0.198.00.26**  
Botany Puzzle Piece:  
Flower - Pistil And  
Stamen



**0.198.00.10**  
Botany Puzzle Piece:  
Leaf - Lamina: Right



**0.198.00.19**  
Botany Puzzle Piece:  
Tree - Top Leaves



**0.198.00.27**  
Botany Puzzle Piece:  
Flower - Crown Upper  
Right



**0.198.00.11**  
Botany Puzzle Piece:  
Tree - Roots



**0.198.00.20**  
Botany Puzzle Piece:  
Tree - Leaves Upper  
Right

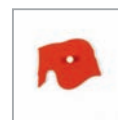

**0.198.00.28**  
Botany Puzzle Piece:  
Flower - Crown Lower  
Right



**0.198.00.12**  
Botany Puzzle Piece:  
Tree - Trunk

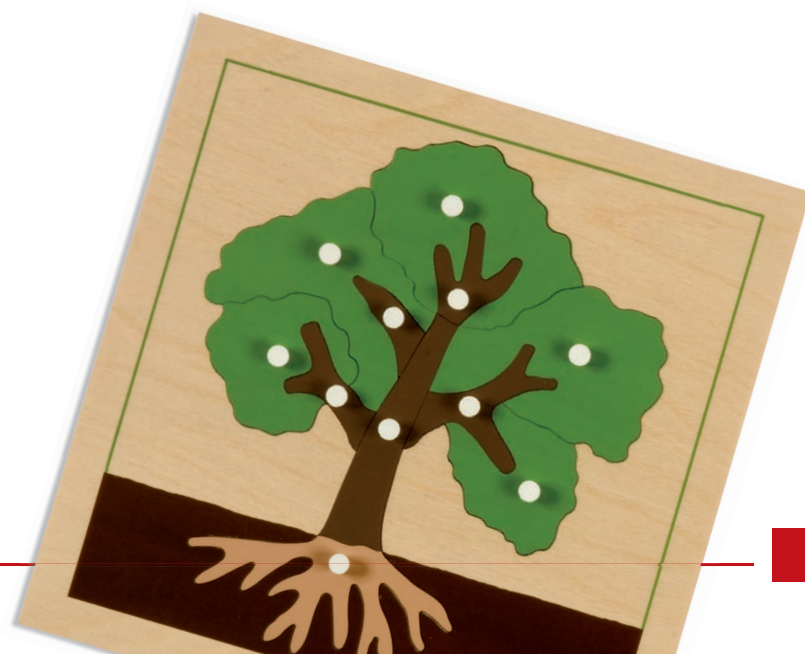



**0.230.00.01**  
Globe:  
Wooden Base



**0.230.00.02**  
Globe:  
Metal Staff For  
Wooden Base



**0.037.00.03**  
White Knobs:  
For Maps/Insets/  
Puzzles



**0.037.00.04**  
White Knobs:  
For Maps/Insets/  
Puzzles (10)



**0.037.00.05**  
White Knobs:  
For Maps/Insets/  
Puzzles (25)



**0.176.C0.01**  
Puzzle Piece  
Of North America:  
Alaska



**0.176.C0.09**  
Puzzle Piece  
Of North America:  
Guatemala



**0.176.C0.02**  
Puzzle Piece  
Of North America:  
Belize



**0.176.C0.10**  
Puzzle Piece  
Of North America:  
Haiti



**0.176.C0.03**  
Puzzle Piece  
Of North America:  
Canada



**0.176.C0.11**  
Puzzle Piece  
Of North America:  
Honduras



**0.176.C0.04**  
Puzzle Piece  
Of North America:  
Costa Rica



**0.176.C0.12**  
Puzzle Piece  
Of North America:  
Mexico



**0.176.C0.05**  
Puzzle Piece  
Of North America:  
Cuba



**0.176.C0.13**  
Puzzle Piece  
Of North America:  
Nicaragua



**0.176.C0.06**  
Puzzle Piece  
Of North America:  
Dominican Republic



**0.176.C0.14**  
Puzzle Piece  
Of North America:  
Panama



**0.176.C0.07**  
Puzzle Piece  
Of North America:  
El Salvador



**0.176.C0.15**  
Puzzle Piece  
Of North America:  
United States



**0.176.C0.08**  
Puzzle Piece  
Of North America:  
Greenland

## Geography



**0.176.E0.01**  
Puzzle Piece  
Of South America:  
Argentina



**0.176.E0.06**  
Puzzle Piece  
Of South America:  
Ecuador



**0.176.E0.10**  
Puzzle Piece  
Of South America:  
Peru



**0.176.E0.02**  
Puzzle Piece  
Of South America:  
Bolivia



**0.176.E0.07**  
Puzzle Piece  
Of South America:  
French Guiana

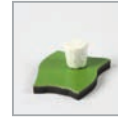

**0.176.E0.11**  
Puzzle Piece  
Of South America:  
Suriname



**0.176.E0.03**  
Puzzle Piece  
Of South America:  
Brazil



**0.176.E0.08**  
Puzzle Piece  
Of South America:  
Guyana



**0.176.E0.12**  
Puzzle Piece  
Of South America:  
Uruguay



**0.176.E0.04**  
Puzzle Piece  
Of South America:  
Chile



**0.176.E0.09**  
Puzzle Piece  
Of South America:  
Paraguay



**0.176.E0.13**  
Puzzle Piece  
Of South America:  
Venezuela



**0.176.E0.05**  
Puzzle Piece  
Of South America:  
Colombia



**Geography**



**0.236.00.01**  
Puzzle Piece Of USA:  
Alabama



**0.236.00.08**  
Puzzle Piece Of USA:  
Delaware



**0.236.00.14**  
Puzzle Piece Of USA:  
Iowa



**0.236.00.02**  
Puzzle Piece Of USA:  
Alaska



**0.236.00.09**  
Puzzle Piece Of USA:  
Florida

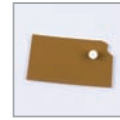

**0.236.00.15**  
Puzzle Piece Of USA:  
Kansas



**0.236.00.03**  
Puzzle Piece Of USA:  
Arizona



**0.236.00.10**  
Puzzle Piece Of USA:  
Georgia



**0.236.00.16**  
Puzzle Piece Of USA:  
Kentucky



**0.236.00.04**  
Puzzle Piece Of USA:  
Arkansas



**0.236.00.11**  
Puzzle Piece Of USA:  
Idaho

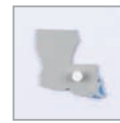

**0.236.00.17**  
Puzzle Piece Of USA:  
Louisiana



**0.236.00.05**  
Puzzle Piece Of USA:  
California



**0.236.00.12**  
Puzzle Piece Of USA:  
Illinois



**0.236.00.18**  
Puzzle Piece Of USA:  
Maine



**0.236.00.06**  
Puzzle Piece Of USA:  
Colorado



**0.236.00.13**  
Puzzle Piece Of USA:  
Indiana



**0.236.00.19**  
Puzzle Piece Of USA:  
Maryland



**0.236.00.07**  
Puzzle Piece Of USA:  
Connecticut



## Geography



**0.236.00.20**  
Puzzle Piece Of USA:  
Massachusetts



**0.236.00.28**  
Puzzle Piece Of USA:  
New Hampshire



**0.236.00.39**  
Puzzle Piece Of USA:  
South Carolina



**0.236.00.21**  
Puzzle Piece Of USA:  
Michigan



**0.236.00.29**  
Puzzle Piece Of USA:  
New Jersey



**0.236.00.40**  
Puzzle Piece Of USA:  
South Dakota



**0.236.00.22**  
Puzzle Piece Of USA:  
Minnesota



**0.236.00.30**  
Puzzle Piece Of USA:  
New Mexico

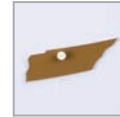

**0.236.00.41**  
Puzzle Piece Of USA:  
Tennessee



**0.236.00.23**  
Puzzle Piece Of USA:  
Mississippi



**0.236.00.31**  
Puzzle Piece Of USA:  
New York



**0.236.00.42**  
Puzzle Piece Of USA:  
Texas



**0.236.00.24**  
Puzzle Piece Of USA:  
Missouri



**0.236.00.32**  
Puzzle Piece Of USA:  
North Carolina

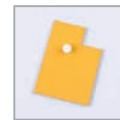

**0.236.00.43**  
Puzzle Piece Of USA:  
Utah



**0.236.00.25**  
Puzzle Piece Of USA:  
Montana



**0.236.00.33**  
Puzzle Piece Of USA:  
North Dakota



**0.236.00.44**  
Puzzle Piece Of USA:  
Virginia



**0.236.00.26**  
Puzzle Piece Of USA:  
Nebraska



**0.236.00.34**  
Puzzle Piece Of USA:  
Ohio



**0.236.00.45**  
Puzzle Piece Of USA:  
Vermont



**0.236.00.27**  
Puzzle Piece Of USA:  
Nevada



**0.236.00.35**  
Puzzle Piece Of USA:  
Oklahoma



**0.236.00.46**  
Puzzle Piece Of USA:  
Washington



**0.236.00.36**  
Puzzle Piece Of USA:  
Oregon



**0.236.00.47**  
Puzzle Piece Of USA:  
West Virginia



**0.236.00.37**  
Puzzle Piece Of USA:  
Pennsylvania



**0.236.00.48**  
Puzzle Piece Of USA:  
Wisconsin



**0.236.00.38**  
Puzzle Piece Of USA:  
Rhode Island



**0.236.00.49**  
Puzzle Piece Of USA:  
Wyoming

**Geography**



**0.176.B0.01**  
Puzzle Piece Of Europe:  
Albania



**0.176.B0.10**  
Puzzle Piece Of Europe:  
Greece



**0.176.B0.15**  
Puzzle Piece Of Europe:  
Iceland



**0.176.B0.02**  
Puzzle Piece Of Europe:  
Belgium/Luxembourg



**0.176.B0.11**  
Puzzle Piece Of Europe:  
United Kingdom



**0.176.B0.16**  
Puzzle Piece Of Europe:  
Italy



**0.176.B0.03**  
Puzzle Piece Of Europe:  
Bosnia/Hercegovina



**0.176.B0.12**  
Puzzle Piece Of Europe:  
Russia



**0.176.B0.17**  
Puzzle Piece Of Europe:  
Croatia



**0.176.B0.04**  
Puzzle Piece Of Europe:  
Bulgaria



**0.176.B0.13**  
Puzzle Piece Of Europe:  
Hungary



**0.176.B0.18**  
Puzzle Piece Of Europe:  
Latvia



**0.176.B0.05**  
Puzzle Piece Of Europe:  
Denmark

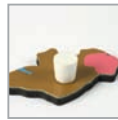

**0.176.B0.14**  
Puzzle Piece Of Europe:  
Ireland



**0.176.B0.06**  
Puzzle Piece Of Europe:  
Germany



**0.176.B0.07**  
Puzzle Piece Of Europe:  
Estonia



**0.176.B0.08**  
Puzzle Piece Of Europe:  
Finland



**0.176.B0.09**  
Puzzle Piece Of Europe:  
France



## Geography



**0.176.B0.19**  
Puzzle Piece Of Europe:  
Lithuania



**0.176.B0.20**  
Puzzle Piece Of Europe:  
Macedonia



**0.176.B0.21**  
Puzzle Piece Of Europe:  
Moldova



**0.176.B0.22**  
Puzzle Piece Of Europe:  
The Netherlands



**0.176.B0.23**  
Puzzle Piece Of Europe:  
Norway



**0.176.B0.24**  
Puzzle Piece Of Europe:  
Ukraine



**0.176.B0.25**  
Puzzle Piece Of Europe:  
Austria



**0.176.B0.26**  
Puzzle Piece Of Europe:  
Poland



**0.176.B0.27**  
Puzzle Piece Of Europe:  
Portugal



**0.176.B0.28**  
Puzzle Piece Of Europe:  
Romania

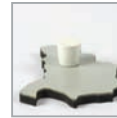

**0.176.B0.29**  
Puzzle Piece Of Europe:  
Serbia/Montenegro



**0.176.B0.30**  
Puzzle Piece Of Europe:  
Slovenia



**0.176.B0.31**  
Puzzle Piece Of Europe:  
Slovakia



**0.176.B0.32**  
Puzzle Piece Of Europe:  
Spain



**0.176.B0.33**  
Puzzle Piece Of Europe:  
Czech Republic



**0.176.B0.34**  
Puzzle Piece Of Europe:  
Belarus



**0.176.B0.35**  
Puzzle Piece Of Europe:  
Sweden



**0.176.B0.36**  
Puzzle Piece Of Europe:  
Switzerland





**0.176.F0.01**  
Puzzle Piece Of Africa:  
Algeria



**0.176.F0.10**  
Puzzle Piece Of Africa:  
Guinea/Sierra Leone/Liberia



**0.176.F0.15**  
Puzzle Piece Of Africa:  
Libya



**0.176.F0.02**  
Puzzle Piece Of Africa:  
Angola



**0.176.F0.11**  
Puzzle Piece Of Africa:  
Cote D'ivoire



**0.176.F0.16**  
Puzzle Piece Of Africa:  
Madagascar



**0.176.F0.03**  
Puzzle Piece Of Africa:  
Botswana



**0.176.F0.12**  
Puzzle Piece Of Africa:  
Cameroon



**0.176.F0.17**  
Puzzle Piece Of Africa:  
Malawi



**0.176.F0.04**  
Puzzle Piece Of Africa:  
Burkina Faso



**0.176.F0.13**  
Puzzle Piece Of Africa:  
Kenya



**0.176.F0.18**  
Puzzle Piece Of Africa:  
Mali



**0.176.F0.05**  
Puzzle Piece Of Africa:  
Central African Republic



**0.176.F0.14**  
Puzzle Piece Of Africa:  
Congo

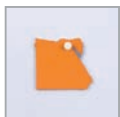

**0.176.F0.06**  
Puzzle Piece Of Africa:  
Egypt



**0.176.F0.07**  
Puzzle Piece Of Africa:  
Ethopia/Djibouti



**0.176.F0.08**  
Puzzle Piece Of Africa:  
Gabon/Equatorial Guinea

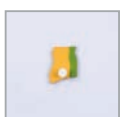

**0.176.F0.09**  
Puzzle Piece Of Africa:  
Ghana/Togo



## Geography



**0.176.F0.19**  
Puzzle Piece Of Africa:  
Morocco



**0.176.F0.20**  
Puzzle Piece Of Africa:  
Mauritania



**0.176.F0.21**  
Puzzle Piece Of Africa:  
Mozambique



**0.176.F0.22**  
Puzzle Piece Of Africa:  
Namibia



**0.176.F0.23**  
Puzzle Piece Of Africa:  
Niger



**0.176.F0.24**  
Puzzle Piece Of Africa:  
Nigeria/Benin

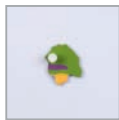

**0.176.F0.25**  
Puzzle Piece Of Africa:  
Senegal/Gambi/  
Guinea - Bissau



**0.176.F0.26**  
Puzzle Piece Of Africa:  
Somalia



**0.176.F0.27**  
Puzzle Piece Of Africa:  
Sudan



**0.176.F0.28**  
Puzzle Piece Of Africa:  
Tanzania/Burundi/Rwanda



**0.176.F0.29**  
Puzzle Piece Of Africa:  
Chad



**0.176.F0.30**  
Puzzle Piece Of Africa:  
Tunisia



**0.176.F0.31**  
Puzzle Piece Of Africa:  
Uganda



**0.176.F0.32**  
Puzzle Piece Of Africa:  
Western Sahara



**0.176.F0.33**  
Puzzle Piece Of Africa:  
Democratic Republic  
Of The Congo



**0.176.F0.34**  
Puzzle Piece Of Africa:  
Zambia



**0.176.F0.35**  
Puzzle Piece Of Africa:  
Zimbabwe



**0.176.F0.36**  
Puzzle Piece Of Africa:  
South Africa/Lesotho/  
Swaziland



**0.176.G0.01**  
Puzzle Piece Of Asia:  
Afghanistan



**0.176.G0.09**  
Puzzle Piece Of Asia:  
Iraq



**0.176.G0.18**  
Puzzle Piece Of Asia:  
North Korea



**0.176.G0.02**  
Puzzle Piece Of Asia:  
Saudi Arabia  
And Others



**0.176.G0.10**  
Puzzle Piece Of Asia:  
Iran



**0.176.G0.19**  
Puzzle Piece Of Asia:  
Pakistan



**0.176.G0.03**  
Puzzle Piece Of Asia:  
Cambodia



**0.176.G0.11**  
Puzzle Piece Of Asia:  
Israel



**0.176.G0.20**  
Puzzle Piece Of Asia:  
Sri Lanka



**0.176.G0.04**  
Puzzle Piece Of Asia:  
China



**0.176.G0.12**  
Puzzle Piece Of Asia:  
Japan



**0.176.G0.21**  
Puzzle Piece Of Asia:  
Syria/Lebanon/  
Jordan



**0.176.G0.05**  
Puzzle Piece Of Asia:  
Philippines



**0.176.G0.13**  
Puzzle Piece Of Asia:  
Laos



**0.176.G0.22**  
Puzzle Piece Of Asia:  
Taiwan



**0.176.G0.06**  
Puzzle Piece Of Asia:  
Russia And Others



**0.176.G0.14**  
Puzzle Piece Of Asia:  
Malaysia/Brunei/  
Singapore



**0.176.G0.23**  
Puzzle Piece Of Asia:  
Thailand



**0.176.G0.07**  
Puzzle Piece Of Asia:  
India/Bangladesh/  
Bhuta



**0.176.G0.15**  
Puzzle Piece Of Asia:  
Mongolia



**0.176.G0.24**  
Puzzle Piece Of Asia:  
Turkey



**0.176.G0.08**  
Puzzle Piece Of Asia:  
Indonesia



**0.176.G0.16**  
Puzzle Piece Of Asia:  
Myanmar



**0.176.G0.25**  
Puzzle Piece Of Asia:  
Vietnam



**0.176.G0.17**  
Puzzle Piece Of Asia:  
Nepal



**0.176.G0.26**  
Puzzle Piece Of Asia:  
South Korea



## Geography



**0.176.H0.01**  
Puzzle Piece Of Australia:  
New South Wales



**0.176.H0.06**  
Puzzle Piece Of Australia:  
Southern Australia



**0.176.H0.02**  
Puzzle Piece Of Australia:  
New Guinea



**0.176.H0.07**  
Puzzle Piece Of Australia:  
Tasmania



**0.176.H0.03**  
Puzzle Piece Of Australia:  
New Zealand



**0.176.H0.08**  
Puzzle Piece Of Australia:  
Victoria



**0.176.H0.04**  
Puzzle Piece Of Australia:  
Northern Territory



**0.176.H0.09**  
Puzzle Piece Of Australia:  
Western Australia



**0.176.H0.05**  
Puzzle Piece Of Australia:  
Queensland



## Geography



**0.177.00.01**  
Puzzle Piece Of World Parts:  
Africa



**0.177.00.05**  
Puzzle Piece Of World Parts:  
Eastern Asia



**0.177.00.02**  
Puzzle Piece Of World Parts:  
Antarctica East



**0.177.00.06**  
Puzzle Piece Of World Parts:  
Western Asia



**0.177.00.03**  
Puzzle Piece Of World Parts:  
Antarctica West



**0.177.00.07**  
Puzzle Piece Of World Parts:  
Europe



**0.177.00.04**  
Puzzle Piece Of World Parts:  
Australia



**0.177.00.08**  
Puzzle Piece Of World Parts:  
North America



**0.177.00.09**  
Puzzle Piece Of World Parts:  
South America



## Geography



**0.179.01.01**  
Four Maps Of Europe:  
Metal Pin Flag  
In Box



**0.179.01.03**  
Metal Pin Flag:  
Gold (1)



**0.179.01.05**  
Plastic Box For Flags  
(Flags not included)



**0.179.01.02**  
Four Maps Of Europe:  
Flag Decals



**0.179.01.04**  
Four Maps Of Europe:  
Set Of Name Stickers



**0.238.00.01**  
Four Maps Of North America:  
Flag Decals



**0.239.00.01**  
Four Maps Of South America:  
Flag Decals



**0.238.00.02**  
Four Maps Of North America:  
Set Of Name Stickers



**0.239.00.02**  
Four Maps Of South America:  
Set Of Name Stickers



**0.174.A0.01**  
Extra Flags:  
Yellow (1)



**0.174.A3.01**  
Extra Flags:  
Blue (1)



**0.173.01.01**  
Cabinet Of The World Parts:  
Set Of Name Stickers



**0.174.A1.01**  
Extra Flags:  
Red (1)



**0.174.A4.01**  
Extra Flags:  
White (1)



**0.174.A2.01**  
Extra Flags:  
Green (1)



**Geography**  
Flags Of Asia



**0.232.00.01**  
Set Of Flags:  
Asian Countries (49)



**0.232.00.08**  
Flag:  
Kampuchea



**0.232.00.16**  
Flag:  
Iran



**0.232.00.02**  
Flag:  
Brunei

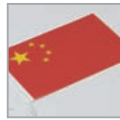

**0.232.00.09**  
Flag:  
China



**0.232.00.17**  
Flag:  
Israel



**0.232.00.03**  
Flag:  
Afganistan



**0.232.00.10**  
Flag:  
Cyprus



**0.232.00.18**  
Flag:  
Japan



**0.232.00.04**  
Flag:  
Bahrain



**0.232.00.11**  
Flag:  
Philippines



**0.232.00.19**  
Flag:  
Jordan



**0.232.00.05**  
Flag:  
Bangladesh



**0.232.00.12**  
Flag:  
Hong Kong



**0.232.00.20**  
Flag:  
Qatar



**0.232.00.06**  
Flag:  
Bhutan



**0.232.00.13**  
Flag:  
India



**0.232.00.21**  
Flag:  
Kuwait



**0.232.00.07**  
Flag:  
Myanmar



**0.232.00.14**  
Flag:  
Indonesia



**0.232.00.22**  
Flag:  
Laos



**0.232.00.15**  
Flag:  
Iraq



**0.232.00.23**  
Flag:  
Lebanon



## Geography Flags Of Asia



**0.232.00.24**  
Flag:  
Malaysia



**0.232.00.25**  
Flag:  
Maldives



**0.232.00.26**  
Flag:  
Mongolia



**0.232.00.27**  
Flag:  
Nepal



**0.232.00.28**  
Flag:  
Yemen



**0.232.00.29**  
Flag:  
North Korea



**0.232.00.30**  
Flag:  
Oman



**0.232.00.31**  
Flag:  
Pakistan



**0.232.00.32**  
Flag:  
Saudi Arabia



**0.232.00.33**  
Flag:  
Singapore



**0.232.00.34**  
Flag:  
Sri Lanka



**0.232.00.35**  
Flag:  
Syria



**0.232.00.36**  
Flag:  
Taiwan



**0.232.00.37**  
Flag:  
Thailand



**0.232.00.38**  
Flag:  
United Arab Emirates



**0.232.00.39**  
Flag:  
Vietnam



**0.232.00.40**  
Flag:  
South Korea



**0.232.00.41**  
Flag:  
Georgia



**0.232.00.42**  
Flag:  
Azerbaijan



**0.232.00.43**  
Flag:  
Armenia



**0.232.00.44**  
Flag:  
Kyrgyzstan



**0.232.00.45**  
Flag:  
Tajikistan



**0.232.00.46**  
Flag:  
Turkmenistan

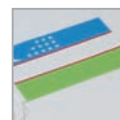

**0.232.00.47**  
Flag:  
Uzbekistan





**Geography**  
Flags Of Europe



**0.233.00.01**  
Set Of Flags:  
European Countries (40)

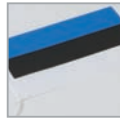

**0.233.00.09**  
Flag:  
Estonia



**0.233.00.17**  
Flag:  
Bulgaria



**0.233.00.02**  
Flagstand:  
35 Holes



**0.233.00.10**  
Flag:  
Latvia



**0.233.00.18**  
Flag:  
Denmark



**0.233.00.03**  
Flag:  
European Community



**0.233.00.11**  
Flag:  
Lithuania



**0.233.00.19**  
Flag:  
Germany



**0.233.00.05**  
Flag:  
Croatia



**0.233.00.12**  
Flag:  
Ukraine



**0.233.00.20**  
Flag:  
Finland

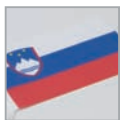

**0.233.00.06**  
Flag:  
Slovenia



**0.233.00.13**  
Flag:  
Moldova



**0.233.00.21**  
Flag:  
France/French Guyana



**0.233.00.07**  
Flag:  
Bosnia/Hercegovina



**0.233.00.14**  
Flag:  
Macedonia



**0.233.00.22**  
Flag:  
Greece



**0.233.00.08**  
Flag:  
Kazakhstan



**0.233.00.15**  
Flag:  
Albania



**0.233.00.23**  
Flag:  
United Kingdom



**0.233.00.16**  
Flag:  
Belgium



**0.233.00.24**  
Flag:  
Hungary



## Geography

### Flags Of Europe



**0.233.00.25**  
Flag:  
Ireland



**0.233.00.33**  
Flag:  
Portugal



**0.233.00.40**  
Flag:  
Switzerland



**0.233.00.26**  
Flag:  
Italy



**0.233.00.34**  
Flag:  
Romania



**0.233.00.41**  
Flag:  
Liechtenstein



**0.233.00.27**  
Flag:  
Serbia



**0.233.00.35**  
Flag:  
Russia



**0.233.00.42**  
Flag:  
Malta



**0.233.00.28**  
Flag:  
Luxemburg



**0.233.00.36**  
Flag:  
Spain



**0.233.00.43**  
Flag:  
Slovak Republic



**0.233.00.29**  
Flag:  
The Netherlands



**0.233.00.37**  
Flag:  
Czech Republic



**0.233.00.44**  
Flag:  
Belarus



**0.233.00.30**  
Flag:  
Norway



**0.233.00.38**  
Flag:  
Iceland



**0.233.00.49**  
Flag:  
Montenegro



**0.233.00.31**  
Flag:  
Austria



**0.233.00.39**  
Flag:  
Sweden



**0.233.A0.30**  
Flag:  
Turkey



**0.233.00.32**  
Flag:  
Poland

### Flags Of Australia



**0.233.00.45**  
Flag:  
Australia



**0.233.00.46**  
Flag:  
New Zealand



**0.233.00.47**  
Flags:  
Stick Only



**0.233.00.48**  
Flags:  
Base Only

**Geography**  
Flags Of Africa



**0.233.B0.01**  
Set Of Flags:  
African Countries (53)



**0.233.B0.10**  
Flag:  
Central African Republic



**0.233.B0.19**  
Flag:  
Guinea



**0.233.B0.02**  
Flag:  
Sao Tome En Principe



**0.233.B0.11**  
Flag:  
Cape Verdian Islands



**0.233.B0.20**  
Flag:  
Gambia



**0.233.B0.03**  
Flag:  
Eritrea



**0.233.B0.12**  
Flag:  
Comoros



**0.233.B0.21**  
Flag:  
Ivory Coast

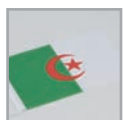

**0.233.B0.04**  
Flag:  
Algeria



**0.233.B0.13**  
Flag:  
Egypt



**0.233.B0.22**  
Flag:  
Guinea-Bissau



**0.233.B0.05**  
Flag:  
Angola

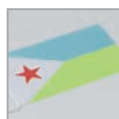

**0.233.B0.14**  
Flag:  
Djibouti



**0.233.B0.23**  
Flag:  
Cameroon



**0.233.B0.06**  
Flag:  
Benin



**0.233.B0.15**  
Flag:  
Ethiopia



**0.233.B0.24**  
Flag:  
Kenya



**0.233.B0.07**  
Flag:  
Botswana



**0.233.B0.16**  
Flag:  
Gabon



**0.233.B0.25**  
Flag:  
The Congo



**0.233.B0.08**  
Flag:  
Burkina Faso



**0.233.B0.17**  
Flag:  
Equatoria Guinea



**0.233.B0.26**  
Flag:  
Lesotho



**0.233.B0.09**  
Flag:  
Burundi



**0.233.B0.18**  
Flag:  
Ghana



**0.233.B0.27**  
Flag:  
Liberia



## Geography

### Flags Of Africa

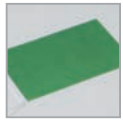

**0.233.B0.28**  
Flag:  
Libya



**0.233.B0.37**  
Flag:  
Namibia



**0.233.B0.46**  
Flag:  
Tanzania



**0.233.B0.29**  
Flag:  
Mauritius



**0.233.B0.38**  
Flag:  
Niger



**0.233.B0.47**  
Flag:  
Togo



**0.233.B0.30**  
Flag:  
Madagascar



**0.233.B0.39**  
Flag:  
Nigeria



**0.233.B0.48**  
Flag:  
Chad



**0.233.B0.31**  
Flag:  
Malawi



**0.233.B0.40**  
Flag:  
Swaziland



**0.233.B0.49**  
Flag:  
Tunisia



**0.233.B0.32**  
Flag:  
Mali



**0.233.B0.41**  
Flag:  
Rwanda



**0.233.B0.50**  
Flag:  
Uganda



**0.233.B0.33**  
Flag:  
Morocco



**0.233.B0.42**  
Flag:  
Senegal



**0.233.B0.51**  
Flag:  
Democratic Republic  
Of Congo



**0.233.B0.34**  
Flag:  
Mauritania



**0.233.B0.43**  
Flag:  
Sierra Leone



**0.233.B0.52**  
Flag:  
Zambia



**0.233.B0.35**  
Flag:  
Seychelles



**0.233.B0.44**  
Flag:  
Sudan



**0.233.B0.53**  
Flag:  
Zimbabwe



**0.233.B0.36**  
Flag:  
Mozambique



**0.233.B0.45**  
Flag:  
Somalia



**0.233.B0.54**  
Flag:  
South Africa



Flags Of North And South America



**0.233.00.04**  
Set Of Flags:  
North And South America (30)



**0.233.A0.11**  
Flag:  
Ecuador



**0.233.A0.22**  
Flag:  
Peru



**0.233.A0.02**  
Flag:  
Argentina



**0.233.A0.12**  
Flag:  
Guatemala



**0.233.A0.23**  
Flag:  
Puerto Rico



**0.233.A0.03**  
Flag:  
Bolivia



**0.233.A0.13**  
Flag:  
Guyana



**0.233.A0.24**  
Flag:  
El Salvador



**0.233.A0.04**  
Flag:  
Brazil



**0.233.A0.14**  
Flag:  
Suriname



**0.233.A0.25**  
Flag:  
Uruguay



**0.233.A0.05**  
Flag:  
Canada



**0.233.A0.15**  
Flag:  
Haiti



**0.233.A0.26**  
Flag:  
Venezuela



**0.233.A0.06**  
Flag:  
Chile



**0.233.A0.16**  
Flag:  
Honduras



**0.233.A0.27**  
Flag:  
United States



**0.233.A0.07**  
Flag:  
Colombia



**0.233.A0.17**  
Flag:  
Belize



**0.233.A0.28**  
Flag:  
Bahamas



**0.233.A0.08**  
Flag:  
Costa Rica



**0.233.A0.18**  
Flag:  
Mexico



**0.233.A0.29**  
Flag:  
Trinidad And Tobago



**0.233.A0.09**  
Flag:  
Cuba



**0.233.A0.19**  
Flag:  
Nicaragua



**0.233.A0.31**  
Flag:  
Jamaica



**0.233.A0.10**  
Flag:  
Dominican Republic



**0.233.A0.20**  
Flag:  
Panama



**0.233.A0.32**  
Flag:  
Greenland



**0.233.A0.21**  
Flag:  
Paraguay



## Enrichment



**0.350.00.01**  
Roman Arch:  
Brick 1 -  
4 x 2 x 2.5



**0.350.00.07**  
Roman Arch:  
Brick 7 -  
2.5 x 2 x 2.5  
Angled Side



**0.350.00.02**  
Roman Arch:  
Brick 2 -  
4.3 x 2 x 2.5  
Angled Side



**0.350.00.08**  
Roman Arch:  
Half Circle



**0.350.00.03**  
Roman Arch:  
Brick 3 -  
2.2 x 1.2 x 2.5



**0.350.00.09**  
Roman Arch:  
Wedge



**0.350.00.04**  
Roman Arch:  
Brick 4 -  
2.2 x 1.9 x 2.5  
Conic



**0.350.00.10**  
Roman Arch:  
Constructor



**0.350.00.05**  
Roman Arch:  
Brick 5 -  
2 x 1.5 x 2.5



**0.350.00.06**  
Roman Arch:  
Brick 6  
3.2 x 1.5 x 2.5  
Angled Side

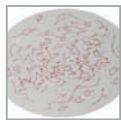

**0.850.00.01**  
Stars Exercise:  
Northern Hemisphere Circle



**0.850.00.02**  
Stars Exercise:  
Southern Hemisphere Circle

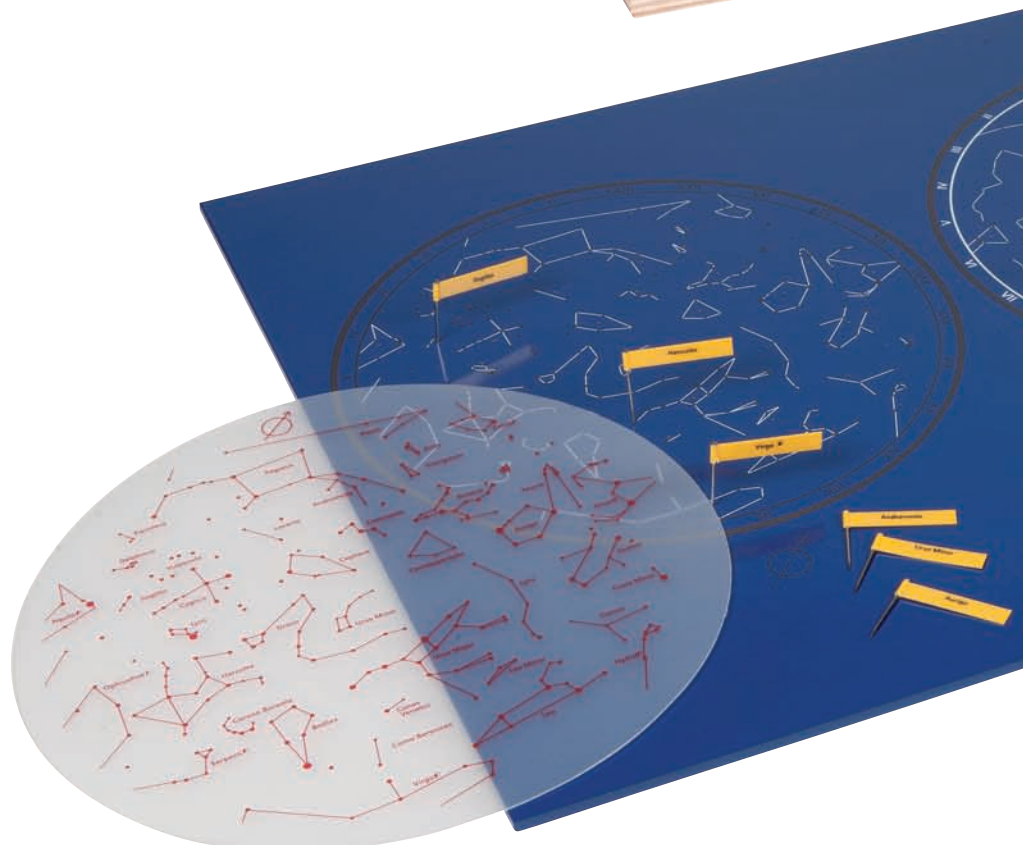

# Index

## Symbols

10 Weights In Wooden Storage Block.....	<b>372</b>
11 Dozen Inset Pencils: 11 Colors.....	<b>84, 261</b>
12 Hole Storage Block: For Pencil/Glue Brushes.....	<b>254</b>
12 Hole Storage Block: For Punch-Out Pins.....	<b>256</b>
12 Hole Storage Block: For Scissors.....	<b>257</b>
• 100 And 1000 Chains Frame.....	<b>148</b>
• 100 Golden Bead Units.....	<b>132</b>
101 Things Everyone Should Know About Science.....	<b>325</b>
• 27 Large Skittles.....	<b>171</b>
3-Sided Inset Pencils.....	<b>84, 259, 260, 261, 344, 345</b>
3-Sided Lead Pencils: (72).....	<b>85, 261, 343</b>
• 3D Object Fitting Exercise.....	<b>30</b>
• 3D Wooden Grammar Symbols.....	<b>106, 107</b>
• 3D Wooden Grammar Symbols: Set Of 10 With Tray.....	<b>106</b>
6 Hole Storage Block: For Pencil/Glue Brushes.....	<b>254</b>
• 45 Golden Bars Of 10 In Box.....	<b>132</b>
99.....	<b>443</b>

## A

'A Key To Writing And Reading For English'.....	<b>93</b>
A Montessori Album.....	<b>316</b>
A New Approach To Zoology Nomenclature.....	<b>326</b>
A Parent's Guide To The Montessori Classroom.....	<b>314</b>
A Parent's Guide To The Montessori Classroom: Spanish.....	<b>314</b>
Accessories.....	<b>246 - 269</b>
Activity Sets.....	<b>248 - 253</b>
• Addition Equations And Sums Box.....	<b>157</b>
• Addition Snake Game.....	<b>155</b>
• Addition Strip Board.....	<b>155</b>
• Addition Strip Board Spareparts.....	<b>510</b>
• Addition Tables.....	<b>155</b>
Addition Tables Booklets.....	<b>157</b>
• Addition Working Charts.....	<b>156</b>
• Addition Working Charts Spareparts.....	<b>510</b>
Adjective Labels For The Farm.....	<b>89</b>
Africa.....	<b>227</b>
Africa Control Maps.....	<b>227</b>
Africa: Labels.....	<b>227</b>
Africa: Paper Maps.....	<b>227</b>
Airer: Paint/Clothes Drying Stand.....	<b>339</b>
• Algebraic Binomial Cube.....	<b>181</b>
• Algebraic Peg Board.....	<b>178</b>
• Algebraic Peg Board Pegs.....	<b>178</b>

Algebraic Peg Board Activity Set: 1.....	<b>178, 251</b>
Algebraic Peg Board Activity Set: 2.....	<b>179, 251</b>
Algebraic Peg Board Spareparts.....	<b>517</b>
Animal Combination Puzzle.....	<b>446</b>
Animal Continent Box.....	<b>364</b>
Animal Names.....	<b>89</b>
Animal Puzzle Activity Set.....	<b>213</b>
Animal Puzzle: Copy Masters.....	<b>213</b>
Animal Puzzle: Copy Masters Box.....	<b>213</b>
Animal Puzzle Cabinet: Five Compartments.....	<b>213</b>
Animal Puzzles.....	<b>212</b>
Animal Puzzles Spareparts.....	<b>520</b>
Animals And Book For The Black Ribbon.....	<b>369</b>
Animals And Their Groups.....	<b>89</b>
Animals And Their Homes.....	<b>89</b>
Animals And Their Sounds.....	<b>89</b>
Animals And Their Young.....	<b>89</b>
Animals Of The World.....	<b>364</b>
Anti-Dust Chalk: Colored.....	<b>343</b>
Anti-Dust Chalk: White.....	<b>343</b>
Apple Tree Counting Set.....	<b>439</b>
Apple Tree Game.....	<b>439</b>
Arbio.....	<b>388</b>
Arbio: Supplementary Set.....	<b>388</b>
Arithmetic Books: Blue.....	<b>264</b>
Arithmetic Books: Green.....	<b>264</b>
Arithmetic Signs Box.....	<b>135</b>
• Arithmetic Trinomial Cube.....	<b>181</b>
• Arithmetic Trinomial Cube Spareparts.....	<b>515</b>
• Arrows And Circles For Sentence Analysis.....	<b>111</b>
• Arrows For Math Material.....	<b>148, 150, 151</b>
• Arrows Spareparts.....	<b>502</b>
Arts And Crafts.....	<b>330 - 353</b>
Asia.....	<b>224</b>
Asia Control Maps.....	<b>224</b>
Asia: Labels.....	<b>224</b>
Asia: Paper Maps.....	<b>224</b>
At Home In Nature: Biology In The Montessori Classroom.....	<b>328</b>
At Home With Montessori.....	<b>312</b>
Atlantis.....	<b>447</b>
Australia.....	<b>222</b>
Australia Control Maps.....	<b>222</b>
Australia: Labels.....	<b>222</b>
Australia: Paper Maps.....	<b>222</b>
Axi.....	<b>409</b>
Axi Plus.....	<b>409</b>

## B

Balls On Small Pegs.....	<b>25</b>
• Bank Game.....	<b>176</b>

Bank Game Activity Set .....	<b>176, 248</b>
• Bank Game Spareparts .....	<b>518</b>
• Baric Tablets .....	<b>58</b>
• Baric Tablets Spareparts .....	<b>484</b>
Basic Ideas Of Montessori's Educational Theory .....	<b>304</b>
Bas Dressing Puzzle .....	<b>450</b>
Bas Lottos .....	<b>393</b>
• Bead Chains .....	<b>149, 150</b>
• Bead Frames .....	<b>167, 168</b>
• Bead Frames Spareparts .....	<b>499</b>
Bead Houses .....	<b>161</b>
• Bead Material .....	<b>129, 151</b>
• Bead Material Cabinet .....	<b>152, 153, 296</b>
• Bead Material Spareparts .....	<b>500, 502, 503, 504, 505</b>
• Bead Stairs .....	<b>154</b>
• Beads - Wooden Colored .....	<b>171</b>
Because No One Was Born A Parent - DVD .....	<b>329</b>
Bell Cabinet .....	<b>76, 299</b>
• Bell Damper .....	<b>74</b>
• Bell Mallet .....	<b>74</b>
• Bells Keyboards .....	<b>75</b>
• Bells Set .....	<b>74</b>
• Bells Music Signs and Notes .....	<b>76</b>
• Bells Music Strip Boards .....	<b>76</b>
• Bells Spareparts .....	<b>492</b>
• Bells Staff Board .....	<b>75</b>
• Bells Staff Boards Set .....	<b>75</b>
Bells Support Materials Set .....	<b>74</b>
Bikes And Trikes .....	<b>464 - 471</b>
• Binomial Cube .....	<b>73, 180</b>
• Binomial Cube Spareparts .....	<b>514</b>
Biology .....	<b>202 - 213</b>
Blackboard Eraser .....	<b>103, 258, 343</b>
• Black And White Bead Stairs .....	<b>154</b>
• Black And White Bead Stairs Spareparts .....	<b>507</b>
Black Ribbon .....	<b>369</b>
• Blindfold .....	<b>58, 61</b>
Blocolo .....	<b>417</b>
Block Puzzle .....	<b>448</b>
• Blue Beads: (100) .....	<b>171</b>
Blunt Scissors: 10 cm .....	<b>257, 351</b>
Books .....	<b>302 - 329</b>
Book Shelf: (69 cm) .....	<b>284</b>
Book Shelf: (101 cm) .....	<b>285</b>
Borboleta .....	<b>422</b>
Botany .....	<b>202 - 213</b>
Botany As A Means Of Development .....	<b>326</b>
• Botany Cabinet .....	<b>204</b>
Botany Cabinet Control Chart .....	<b>204</b>
Botany Cabinet: Nomenclature Cards .....	<b>205</b>
• Botany Cabinet Spareparts .....	<b>520</b>
Botany Cards .....	<b>207, 208, 209</b>

Botany Cards Spareparts .....	<b>520</b>
Botany Puzzle Activity Set .....	<b>211</b>
Botany Puzzle: Copy Masters .....	<b>211</b>
Botany Puzzle: Copy Masters Box .....	<b>211</b>
Botany Puzzle Cabinet: Four Compartments .....	<b>211</b>
Botany Puzzle Spareparts .....	<b>520, 521</b>
Botany Puzzles .....	<b>210</b>
• Bow Tying Frame .....	<b>38</b>
Box For Land Form Cards .....	<b>217</b>
• Box With Bins .....	<b>29</b>
• Box With Cubes For Pink Tower .....	<b>50, 199</b>
• Box With Grey And White Number Tiles .....	<b>173, 175, 187</b>
Box With Large Numeral Cards .....	<b>146</b>
• Box With Prisms For Brown Stair .....	<b>51, 199</b>
• Box With Sliding Lid .....	<b>29</b>
Box With Small Numeral Cards .....	<b>146</b>
• Braiding Board .....	<b>28</b>
• Brooms .....	<b>34, 35</b>
• Brown Stair: Brown Lacquer .....	<b>51</b>
• Brown Stair: Clear Lacquer .....	<b>51</b>
• Brown Stair Spareparts .....	<b>476, 477</b>
Brushes - Paint .....	<b>334, 335</b>
• Buckling Frame .....	<b>40</b>
Bug Box With Magnifying Lid .....	<b>463</b>
Building Blocks: Multi Colored Wood .....	<b>387</b>
Building Blocks: Natural Wood .....	<b>387</b>
Building Spatial .....	<b>430</b>
Bus 20 .....	<b>441</b>
• Buttoning Frame With Large Buttons .....	<b>38</b>
• Buttoning Frame With Small Buttons .....	<b>38</b>

## C

Cabasa - Musical Instrument .....	<b>361</b>
Cabinet For Music Materials .....	<b>356</b>
Cabinet For Paper Maps .....	<b>235, 298</b>
Cabinet Of Europe .....	<b>240</b>
Cabinet Of The World Parts .....	<b>239</b>
Cabinet Of The USA .....	<b>238</b>
Cabinet: 3 Trays (69 cm) .....	<b>287</b>
Cabinet: 5 Trays (101 cm) .....	<b>288</b>
Cabinet: 6 Trays (69 cm) .....	<b>286</b>
Cabinet: 9 Trays (69 cm) .....	<b>287</b>
Cabinet: 10 Trays (101 cm) .....	<b>288</b>
Cabinet: 15 Trays (101 cm) .....	<b>289</b>
Cabinet: 18 Trays (69 cm) .....	<b>287</b>
Cabinet: 30 Trays (101 cm) .....	<b>289</b>
Cabinets With Trays - 69 cm .....	<b>286, 287</b>
Cabinets With Trays - 101 cm .....	<b>288, 289</b>
Calculino .....	<b>435</b>
Camillo Grazzini: Celebrating Fifty Years Of Montessori Svc .....	<b>329</b>



Campolino.....	406	Color And Counting Lotto.....	437
Canada.....	230	Color Box Of 32 Pairs.....	57
Canada Control Maps.....	230	Color Counting And Sorting Game.....	416
Canada: Labels.....	230	Color Dolls.....	420
Cards Of The World Parts.....	236	Color Nuance Game.....	425
Careta.....	421	• Color Tablets.....	56, 57
Carpets.....	78	• Color Tablets Spareparts.....	483
Carpets Stands.....	78, 297	• Colored Bead Stairs.....	154
Casita.....	399	• Colored Counting Bars.....	182
• Centesimal Frame.....	190	• Colored Discs On Colored Dowels.....	23
CD: Children's And Folk Songs.....	323	Colored Inset Pencil Holders.....	84, 254, 346
CD: Green Is Our Garden: Songs Of Nature.....	323	Coloretto.....	420
Chair A1: Orange (26 cm).....	272	• Complete Practical Life Stand.....	34, 294
Chair B2: Violet (31 cm).....	272	Componere.....	424
Chair C3: Yellow (35 cm).....	272	Command Box In A Natural Finish.....	115
Chalk: Anti-Dust.....	343	• Command Boxes.....	115
Chart For Area.....	373	Commands For The Geometric Solids.....	71
Chart For Calculation Of Volume.....	374	Comparant.....	414
Chart For Liters.....	375	Concentra.....	396
Chart For Measurement.....	373	Conjunction And Prepositions.....	87
Chart For Weight.....	374	• Constructive Blue Triangles.....	64
Chart For Multibase Material.....	183	Constructive Blue Triangles Activity Set.....	64, 250
Chart With Explanation Of The Abbreviations.....	375	• Constructive Triangles.....	62
• Checker Board.....	172	• Constructive Triangles Spareparts.....	486, 487
Checker Board Activity Set.....	173, 248	Continent.....	220, 221
• Checker Board Beads.....	172, 186	Continent: Labels.....	221
Child Education.....	307	Contini.....	434
Child-Size Masterpieces: Advanced (3).....	321	Control Chart: Hundred Board.....	144
Child-Size Masterpieces: Artists Names (4).....	321	Control Chart: Hundred Board With Roman Numerals.....	145
Child-Size Masterpieces: Black Images.....	322	Control Chart: Pythagoras Board.....	147
Child-Size Masterpieces: Easy (1).....	321	Control Maps.....	220 - 231
Child-Size Masterpieces: Famous Paintings (5).....	321	• Counters - Colored.....	127
Child-Size Masterpieces: How To Use.....	321	Counting Circle Puzzle.....	444
Child-Size Masterpieces: Intermediate (2).....	321	Counting Lotto.....	437
Child-Size Masterpieces: Modern Schools Of Art.....	322	Craft Materials.....	330 - 353
Child-Size Masterpieces: Transportation In America.....	322	Craft Mats.....	350
Children Of The Universe.....	316	Craft Paper: Round.....	347
Children's And Folk Songs.....	323	Craft Paper: Square.....	347
Children's And Folk Songs - CD.....	323	Craft Paper Boxes.....	347
Circle Puzzle: Animals.....	455	Crayons: 12 Colors.....	342
Circle Puzzle: Profession.....	455	Creative Development In The Child: Volume 1 & 2.....	305
Circleline Bikes And Trikes.....	468 - 471	Crepe Paper: 10 Colors.....	348
• Circles, Squares And Triangles.....	64	Criteria.....	391
• Circles, Squares And Triangles Spareparts.....	488	• Cubes For Pink Tower.....	50, 199
Citadel.....	394	• Cubes On Verticle Dowel.....	22
Classicant I & II.....	411	• Cubing Material.....	182
Clock Exercise.....	377	• Cubing Material Spareparts.....	516
Clock Stamps - Rubber.....	378	• Cut-Out Labeled Fraction Circles.....	192
Clock With Movable Hands.....	377	• Cut-Out Labeled Fraction Circles Spareparts.....	517
Clothes Pins.....	339	Cut-Out Numerals Box.....	128
Collall Glue/Paste.....	353	Cut-Out Numerals: Cursive.....	128
Colodie Puzzle Game.....	427	Cut-Out Numerals: Print.....	128

Cut-Out Numerals: USA Style Print .....	128
• Cut-Out Numerals And Counters: Cursive.....	126
• Cut-Out Numerals And Counters: Print.....	126
• Cut-Out Numerals And Counters: USA Style Print.....	126
Cut-Out Numerals And Counters Activity Set.....	127, 252
• Cut-Out Numerals And Counters Spareparts.....	482
• Cutting And Scissor Tray.....	42, 257, 351
Cutting Mats .....	351
• Cylinder Blocks.....	52
• Cylinder Blocks Spareparts .....	478, 479
• Cylinders.....	52, 53

## D

• Decanomial Bead Bar Box.....	174
• Decanomial Paper.....	174
• Decimal Checker Board.....	186
• Decimal Fraction Board.....	185
• Decimal Fraction Exercise.....	185
Decimal Fraction Exercise Activity Set.....	185, 252
Decimal Stamp Game .....	184
• Demonstration Tray.....	66
Design Board.....	426
Details.....	422
• Detective Adjective Exercise .....	86
Detective Adjective Exercise Commands .....	86
• Detective Adjective Exercise Spareparts .....	494
Diaro.....	392
Dinos.....	447
• Discs On Horizontal Dowel .....	22
• Discs On Vertical Dowel.....	22
Dish Washing Table .....	47, 277
• Division Board.....	165
• Division Equations And Dividends Box .....	166
• Division Tables.....	165
Division Tables Booklets .....	165
• Division Working Charts.....	166
• Division Working Charts Spareparts .....	513
Djembe Drums .....	359
• Dot Exercise.....	138
Dot Exercise Activity Set.....	139, 249
Dot Exercise Pens.....	138
• Dot Exercise Sheets: (50) .....	139
Dotsy .....	436
Double Lined Paper: (250).....	117, 263
Double Lined Paper: Narrow Lines (250) .....	117, 263
• Double Sandpaper Letters Box.....	92
• Double Sandpaper Letters: Cursive .....	92
• Double Sandpaper Letters: Print.....	92
Draw What's Missing: Set 1 .....	384
Draw What's Missing: Set 2 .....	384

Dresscode.....	391
• Dressing Frames .....	38, 39, 40
• Dressing Frames Stand.....	41, 294
Dr. Montessori's Own Handbook.....	306
Drums - Musical Instruments .....	357, 359, 360, 361
Drying Racks - Painting .....	338
Drying Stand - Painting/Clothes.....	339
Dubbeldam .....	407
Dubio.....	442
Dubio Junior .....	440
Duo Jigsaw Puzzle: 1.....	452
Duo Jigsaw Puzzle: 2.....	452
Duo Lotti .....	397
• Dust Brush With Handle .....	36
• Dust Pan .....	36
DVD's.....	328, 329
DVD: At Home In Nature: Biology In The Classroom.....	328
DVD: Because No One Was Born A Parent .....	329
DVD: "Maria Montessori" Her Life And Legacy.....	328
DVD: Montessori In Action .....	329

## E

Educo Bikes And Trikes.....	466, 467
Easel: 2 Boards.....	300, 340
Easel: 4 Boards.....	301, 341
Easy Reading Booklets.....	94
Educateurs sans Frontieres.....	318
Education And Peace.....	304
Education As A Help To Life .....	320
Education For A New World .....	305
Education For Human Development.....	308
Eelde Set.....	418
• Elementary Geometric Solids .....	200, 201
• Elementary Negative Snake Game .....	158
• Elementary Negative Snake Game Spareparts.....	508
Ellipsoids On Small Pegs.....	25
Embroidery/Sewing Paper - Assorted Colors .....	348
End Cabinet: 3 Straight Shelves (101 cm) .....	283
End Cabinet: 6 Compartments (69 cm) .....	280
End Cabinet: 6 Compartments (101 cm) .....	283
End Cabinet: Rounded Shelves (69 cm).....	280
End Cabinet: Rounded Shelves (101 cm).....	282
End Cabinet: Tiered Shelves (69 cm) .....	280
End Cabinet: Tiered Shelves (101 cm) .....	282
End Cabinets - 69 cm.....	280
End Cabinets - 101 cm.....	282, 283
Enrichment.....	362 - 463
• Equivalent Figure Material.....	195
Europe.....	223
Europe Control Maps.....	223

Europe: Labels.....	<b>223</b>
Europe: Paper Maps.....	<b>223</b>
Evolution Time Line.....	<b>370</b>
Exercise Chart: Measurement Material.....	<b>375</b>
• Explanation Grammar Boxes.....	<b>115</b>
• Extra Circle For Tracing.....	<b>220</b>
• Extra Flags For Pin Maps.....	<b>237, 238, 239, 240, 533</b>

## F

• Fabric Box.....	<b>58</b>
Farfalla.....	<b>434</b>
• Farm.....	<b>88</b>
• Farm Spareparts.....	<b>494</b>
• Farm Table.....	<b>88, 295</b>
Feelings And Emotions.....	<b>392</b>
Figuroform.....	<b>432</b>
Figurogram.....	<b>430</b>
Figurondo.....	<b>427</b>
Find The Shape.....	<b>428</b>
Finger Paint.....	<b>332</b>
Finger Paint Pots.....	<b>336</b>
Finger Puppets.....	<b>43, 44, 45</b>
First Aid Kits For Materials.....	<b>265</b>
First Books.....	<b>94</b>
• First Box Of Color Tablets.....	<b>56</b>
First Set Of Botany Cards.....	<b>207</b>
First Set Of Botany Cards Box.....	<b>207</b>
Five In A Row.....	<b>445</b>
• Five Yellow Prisms In Wooden Box.....	<b>198</b>
Flag Paper.....	<b>243</b>
Flag Puzzle Of Europe.....	<b>449</b>
Flag Puzzle Of The Americas.....	<b>449</b>
• Flag Stand Of Africa.....	<b>242</b>
• Flag Stand Of Asia.....	<b>242</b>
• Flag Stand Of Europe.....	<b>242</b>
• Flag Stand Of North And South America.....	<b>242</b>
• Flags: Individual.....	<b>534 - 540</b>
• Flags: Stick Only.....	<b>537</b>
• Flags: Base Only.....	<b>537</b>
• Flags For Pin Maps.....	<b>237, 238, 239, 240</b>
Flags Of Africa.....	<b>244</b>
Flags Of Asia.....	<b>244</b>
Flags Of Europe.....	<b>244</b>
Flags Of North America.....	<b>245</b>
Flags Of South America.....	<b>245</b>
Flags Of The United States.....	<b>245</b>
• Flat Bead Frame.....	<b>175</b>
Flat Bead Frame Activity Set.....	<b>175, 249</b>
Flip Flop.....	<b>441</b>
Floor Puzzle: The Farm.....	<b>460</b>

Floor Puzzle: The House.....	<b>460</b>
Floor Puzzle: The Zoo.....	<b>461</b>
Folk Songs From Around The World.....	<b>323</b>
• Four Maps Of Europe.....	<b>236</b>
• Four Maps Of North America.....	<b>237</b>
• Four Maps Of South America.....	<b>237</b>
• Four Maps Spareparts.....	<b>533</b>
Fraction Cabinet.....	<b>197</b>
• Fraction Circles.....	<b>191, 192</b>
• Fraction Circles Stands: [2].....	<b>191</b>
Fraction Equivalent Research Sheets.....	<b>192</b>
Fraction Labels.....	<b>192</b>
• Fraction Material.....	<b>190 - 197</b>
Fraction Problems: Series 1.....	<b>192</b>
• Fraction Skittles.....	<b>190</b>
• Fraction Skittles Spareparts.....	<b>518</b>
Fractions Activity Set: 1.....	<b>193, 251</b>
Fractions Activity Set: 2.....	<b>193, 251</b>
Fractions Activity Set: 3.....	<b>193, 251</b>
Fröbel Magnetic Mosaic Set.....	<b>432</b>
From Childhood To Adolescence.....	<b>306</b>
Frutty.....	<b>390</b>
Furniture.....	<b>270 - 301</b>

## G

Geo.....	<b>448</b>
Geo Forms Play.....	<b>427</b>
Geography.....	<b>214 - 245</b>
Geometric Beginning Labels.....	<b>69</b>
• Geometric Cabinet.....	<b>66</b>
Geometric Cabinet Activity Set.....	<b>68, 250</b>
Geometric Cabinet Advanced Triangle Labels.....	<b>69</b>
Geometric Cabinet Control Book.....	<b>68</b>
Geometric Cabinet Control Chart.....	<b>68</b>
Geometric Cabinet Nomenclature Cards.....	<b>69</b>
• Geometric Cabinet Spareparts.....	<b>488, 489</b>
• Geometric Cards.....	<b>70</b>
• Geometric Form Card Box.....	<b>67</b>
• Geometric Form Card Cabinet.....	<b>67</b>
• Geometric Form Cards.....	<b>67</b>
• Geometric Form Cards For The Demonstration Tray.....	<b>66</b>
• Geometric Hierarchy Number Cards.....	<b>169</b>
• Geometric Hierarchy Of Numbers.....	<b>169</b>
• Geometric Hierarchy Of Numbers Spareparts.....	<b>509</b>
• Geometric Plane Figures With Box.....	<b>70</b>
Geometric Sand Shapes.....	<b>463</b>
• Geometric Solids.....	<b>70</b>
• Geometric Solids Activity Set.....	<b>71, 250</b>
• Geometric Solids Basket.....	<b>70</b>
Geometric Solids Control Book.....	<b>71</b>

Geometric Solids Copy Masters.....	<b>71</b>
• Geometric Solids Spareparts.....	<b>490</b>
• Geometric Stick Material.....	<b>188</b>
Geometry/Biology Cabinet (69 cm).....	<b>72, 206, 293</b>
Geometry/Biology Cabinet (101 cm).....	<b>72, 206, 293</b>
• Globe Of Land And Water.....	<b>216</b>
• Globe Of The Continents.....	<b>216</b>
Globe Of The World Parts.....	<b>216</b>
• Globe Spareparts.....	<b>522</b>
Globe Projection Map: Set Of 10.....	<b>216</b>
Glue.....	<b>352, 353</b>
• Glue And Paste Box.....	<b>42, 255, 352</b>
Glue Or Paste Brush.....	<b>255, 352</b>
Glue/Paint/Paste Jar With Lid: (50 cc).....	<b>255, 352</b>
Glutofix.....	<b>353</b>
• Golden Bars Of 10 In Box.....	<b>132</b>
• Golden Bead Chain Of 100.....	<b>148</b>
• Golden Bead Chain Of 1000.....	<b>149</b>
• Golden Bead Chains Frame - 100 And 1000.....	<b>148</b>
• Golden Bead Cube Of 1000.....	<b>132</b>
• Golden Bead Material.....	<b>131, 132, 133, 134</b>
Golden Bead Material Activity Set.....	<b>131, 248</b>
• Golden Bead Material Spareparts.....	<b>498</b>
• Golden Bead Square Of 100.....	<b>132</b>
• Golden Bead Units.....	<b>132</b>
Grammar.....	<b>104 - 115</b>
• Grammar Boxes.....	<b>112</b>
• Grammar Cards.....	<b>114</b>
• Grammar Command Boxes.....	<b>115</b>
Grammar Exercises.....	<b>86</b>
• Grammar Filling Boxes.....	<b>113</b>
Grammar Sense Game: Set 1.....	<b>108</b>
• Grammar Spareparts.....	<b>496</b>
Grammar Symbol Tiles.....	<b>109</b>
• Grammar Symbols.....	<b>104, 105, 106, 107</b>
• Grammar Symbols Box: 10 Compartments.....	<b>104</b>
• Grammar Symbols Box: 15 Compartments.....	<b>104</b>
Grammar Symbols Template.....	<b>104</b>
Gratnells Trays.....	<b>290, 291</b>
• Green Beads: (100).....	<b>171</b>
• Greenboards.....	<b>102</b>
• Greenboards Blank: Set Of 2.....	<b>102</b>
Greenboards Stand.....	<b>103, 295</b>
• Greenboards With Double Lines And Squares: Set Of 2.....	<b>102</b>
• Greenboards With Lines And Squares: Set Of 2.....	<b>102</b>
Green Is Our Garden: Songs Of Nature.....	<b>323</b>
Green Is Our Garden: Songs Of Nature - CD.....	<b>323</b>
Grimas.....	<b>403</b>
Grippy.....	<b>379</b>
Group Table A1: Orange (120 x 80 x 46 cm).....	<b>275</b>
Group Table B2: Violet (120 x 80 x 53 cm).....	<b>275</b>
Group Table C3: Yellow (120 x 80 x 59 cm).....	<b>275</b>

Group Table A1: Orange - Round (115 x 46 cm).....	<b>276</b>
Group Table B2: Violet - Round (115 x 53 cm).....	<b>276</b>
Group Table C3: Yellow - Round (115 x 59 cm).....	<b>276</b>
Growth Puzzles.....	<b>456, 457, 458</b>
Guiro - Musical Instrument.....	<b>361</b>

## H

Hand Bells.....	<b>360</b>
Hand Drum.....	<b>361</b>
Hand-Eye Coordination.....	<b>385</b>
Hand Washing Table.....	<b>46, 277</b>
Happy Hammer: Farm.....	<b>429</b>
Happy Hammer: Geo.....	<b>429</b>
Helping The Child Unfold Its Potential.....	<b>316</b>
Hemisphere Maps And Labels Set.....	<b>221</b>
Heutink Basic Markers: Fine Point - 10 Colors.....	<b>342</b>
Heutink Basic Markers: Medium Point - 10 Colors.....	<b>342</b>
Heutink Gigantjes Markers: Thick Point - 10 Colors.....	<b>342</b>
Heutink Goldline: Lead Pencils (12).....	<b>85, 261, 343</b>
• Hierarchy Of Numbers.....	<b>169</b>
• Hierarchy Of Numbers Spareparts.....	<b>509</b>
• Holder For 3 Pencils.....	<b>84, 258</b>
Honoring The Light Of The Child.....	<b>317</b>
• Hook And Eye Frame.....	<b>39</b>
• Horizontal Dowel Variation - Serpentine.....	<b>24</b>
• Horizontal Dowel Variation - Straight.....	<b>24</b>
How To Raise An Amazing Child.....	<b>310</b>
How To Use Child-Size Masterpieces.....	<b>321</b>
Hundred Board.....	<b>144</b>
Hundred Board Activity Set.....	<b>144, 250</b>
Hundred Board: Control Chart.....	<b>144</b>
Hundred Board Copy Masters.....	<b>145, 250</b>
Hundred Board Spareparts.....	<b>501</b>
Hundred Board With Roman Numerals.....	<b>145</b>
Hundred Board With Roman Numerals: Control Chart.....	<b>145</b>

## I

I Can Do It! - Piano Book.....	<b>324</b>
Illustrated Poems.....	<b>94</b>
Imbucare Board With Disc.....	<b>20</b>
Imbucare Board With Knit Ball.....	<b>20</b>
Imbucare Box With 3 Colored Knit Balls.....	<b>19</b>
• Imbucare Box With Cube.....	<b>16</b>
Imbucare Box With Flip Lid - 1 Slot.....	<b>17</b>
• Imbucare Box With Flip Lid - 4 Shapes.....	<b>17</b>
Imbucare Box With Flip Lid - Knit Ball.....	<b>18</b>
• Imbucare Box With Knit Ball.....	<b>18</b>
• Imbucare Box With Large Cylinder.....	<b>15</b>

• Imbucare Box With Rectangular Prism.....	<b>16</b>
• Imbucare Box With Small Cylinder.....	<b>15</b>
• Imbucare Box With Triangular Prism.....	<b>16</b>
• Imbucare Peg Box.....	<b>19</b>
In A Montessori Home.....	<b>312</b>
• Individual Golden Bead Material.....	<b>132</b>
• Individual Grammar Symbols.....	<b>105</b>
Individual Reading Material.....	<b>95</b>
Indoor Broom: Coarse Brown.....	<b>24</b>
• Indoor Broom: Soft Black.....	<b>34</b>
• Infant Bell.....	<b>31</b>
Infant Toddler.....	<b>12 - 31</b>
Infant Toddler Mirror.....	<b>30</b>
• Infant Toddler Dressing Frames.....	<b>26, 27</b>
• Infant Toddler Spareparts.....	<b>474</b>
Ink Pad.....	<b>378</b>
Inlay Board Puzzle: Animals.....	<b>453</b>
Inlay Board Puzzle: Animals Circle.....	<b>455</b>
Inlay Board Puzzle: Fruit.....	<b>453</b>
Inlay Board Puzzle: Profession Circle.....	<b>455</b>
Inscribed And Concentric Figures Activity Set.....	<b>65, 252</b>
• Inscribed And Concentric Figures: Paper.....	<b>65</b>
• Inscribed And Concentric Figures: Plastic.....	<b>65</b>
• Inscribed And Concentric Figures: Metal.....	<b>194</b>
Insert Mosaic: 15 mm.....	<b>431</b>
Inset Paper: (3000).....	<b>84, 263</b>
• Inset Paper Box: 14 x 14 cm.....	<b>258</b>
Inset Pencils.....	<b>84, 259, 260, 261, 344, 345</b>
• Insets.....	<b>82</b>
• Insets Spareparts.....	<b>493</b>
• Instrument For The Measurement Of Angles.....	<b>190</b>
Instruments Of The World: In Basket.....	<b>358</b>
Interglue: White Glue.....	<b>352</b>
• Interlocking Discs.....	<b>31</b>
• Introduction To Decimal Quantity.....	<b>130</b>
• Introduction To Decimal Symbol.....	<b>130</b>
• Introduction To The Decimal System.....	<b>130</b>
I Wonder What's Out There.....	<b>325</b>

## J

Jumbo Insert Mosaic.....	<b>431</b>
--------------------------	------------

## K

Koloranto.....	<b>419</b>
• Knobless Cylinders.....	<b>53</b>
• Knobless Cylinders Spareparts.....	<b>480, 481</b>
Kralo.....	<b>426</b>
Kwinto Motor Skills Set.....	<b>386</b>

Kwinto Stereoboard.....	<b>386</b>
Kwinto Whiteboard Markers: 10.....	<b>386</b>

## L

• Lacing Frame.....	<b>38</b>
Land And Water Form Cards Sets.....	<b>218</b>
Land And Water Form Trays.....	<b>217</b>
Land And Water Forms: Card Sets.....	<b>219</b>
Land And Water Forms: Command Cards.....	<b>219</b>
Land And Water Forms: Labels.....	<b>217</b>
Land Form Cards.....	<b>217</b>
Land Form Cards Box.....	<b>217</b>
Land Of The Parts Of Speech.....	<b>109</b>
Language.....	<b>80 - 117</b>
• Large Bead Frame.....	<b>168</b>
Large Bead Frame Activity Set.....	<b>168, 249</b>
• Large Bead Frame Paper: (50 sheets).....	<b>168</b>
Large Chart Of The World.....	<b>241</b>
• Large Fraction Skittles.....	<b>190</b>
• Large Fraction Skittles Spareparts.....	<b>518</b>
• Large Movable Alphabet: Cursive.....	<b>96</b>
• Large Movable Alphabet: Print.....	<b>96</b>
• Large Movable Alphabet Box: Cursive.....	<b>96</b>
• Large Movable Alphabet Box: Print.....	<b>96</b>
• Large Number Cards, 1-1000.....	<b>134</b>
• Large Number Cards, 1-9000.....	<b>134</b>
• Large Number Cards Box.....	<b>134</b>
Large Numeral Cards In Box.....	<b>146</b>
• Large Skittles.....	<b>171</b>
• Large Working Board For The Geometric Stick Material.....	<b>188</b>
Layer Puzzle: Daily Routine.....	<b>459</b>
Lead Pencils.....	<b>85, 261, 343</b>
• Leaf Cards.....	<b>205</b>
• Leaf Cards Box.....	<b>205</b>
• Leaf Cards Cabinet.....	<b>205</b>
Legumo.....	<b>390</b>
Lined Paper.....	<b>116, 117, 262, 263</b>
Listen Well.....	<b>399</b>
• List of Factors Tables.....	<b>164</b>
Logicards.....	<b>418</b>
Logical Adjective Exercise.....	<b>86</b>
Logical Adverb Exercise.....	<b>86</b>
• Long Division.....	<b>170</b>
Long Division Activity Set.....	<b>170, 249</b>
• Long Division Spareparts.....	<b>509</b>
Look At The Child.....	<b>315</b>
• Loose Spindles Box.....	<b>123</b>
Love Of Learning: Supporting Intrinsic Motivation.....	<b>319</b>

<b>M</b>	
Magnetic Counting Board .....	<b>445</b>
Manual For An Integrated Approach To Mathematics .....	<b>318</b>
Manual On Cosmic Education: An Integrated Approach.....	<b>318</b>
Maracas - Musical Instruments .....	<b>359</b>
Maria Montessori.....	<b>308</b>
Maria Montessori 100 Years: 1907 - 2007 Centenary.....	<b>308</b>
Maria Montessori Farmschool Erdkinder .....	<b>315</b>
Maria Montessori: Her Life And Legacy - DVD .....	<b>328</b>
Maria Montessori: Her Life And Work .....	<b>308</b>
Markers: 10 Colors - Fine Point.....	<b>342</b>
Markers: 10 Colors - Medium Point .....	<b>342</b>
Markers: 10 Colors - Thick Point.....	<b>342</b>
Material Cabinet: 6 Compartments (69 cm).....	<b>279</b>
Material Cabinet: 8 Compartments (101 cm).....	<b>281</b>
Material Cabinet: 9 Compartments (69 cm).....	<b>279</b>
Material Cabinet: 9 Compartments (101 cm).....	<b>281</b>
Material Cabinet: 12 Compartments (69 cm).....	<b>279</b>
Material Cabinet: 12 Compartments (101 cm).....	<b>281</b>
Material Cabinets - 69 cm.....	<b>278, 279, 280, 284, 286, 287</b>
Material Cabinets - 101 cm.....	<b>281, 282, 283, 285, 288, 289</b>
Material First Aid Kit: Math.....	<b>265</b>
Material First Aid Kit: Sensorial .....	<b>265</b>
Material Repair Paints .....	<b>266, 267</b>
Math Bus.....	<b>440</b>
Math Works: Montessori Math And The Developing Brain.....	<b>310</b>
Mathematics.....	<b>118 - 201</b>
Matrix Mix .....	<b>406</b>
Measurement Material.....	<b>373, 374, 375</b>
• Medium Movable Alphabet: Cursive, Blue.....	<b>98</b>
• Medium Movable Alphabet: Cursive, Red.....	<b>98</b>
• Medium Movable Alphabet: Print, Blue.....	<b>98</b>
• Medium Movable Alphabet: Print, Red.....	<b>98</b>
• Medium Movable Alphabet: Spanish, Print .....	<b>99</b>
• Medium Movable Alphabet Box.....	<b>99</b>
• Medium Movable Alphabet Box Spanish .....	<b>99</b>
Memos .....	<b>404, 405</b>
Menu .....	<b>402</b>
• Metal Material .....	<b>194, 195, 196</b>
• Metal Insets .....	<b>82</b>
• Metal Inset Stands.....	<b>82</b>
• Metal Insets Spareparts.....	<b>493</b>
Metal Shaker Tube - Musical Instrument.....	<b>361</b>
• Metal Squares: 9 Plates .....	<b>194</b>
• Metal Triangles: 4 Plates .....	<b>194</b>
• Metal Volume Containers.....	<b>199</b>
Mexico .....	<b>231</b>
Mexico Control Maps.....	<b>231</b>
Mexico: Labels.....	<b>231</b>
Mini Memo .....	<b>402</b>
Mini, Midi, Maxi.....	<b>395</b>
Montessori: A Modern Approach .....	<b>313</b>
Montessori And Your Child: A Primer For Parents .....	<b>315</b>
Montessori Comes To America.....	<b>329</b>
Montessori Education.....	<b>305</b>
Montessori For You And Your Child.....	<b>311</b>
Montessori From The Start: Child From Birth To Three .....	<b>310</b>
Montessori Insights: For Parents Of Young Children.....	<b>314</b>
Montessori In Action - DVD.....	<b>329</b>
Montessori In The Classroom.....	<b>313</b>
Montessori Language Program.....	<b>320</b>
Montessori Learning In The 21st Century .....	<b>311</b>
Montessori Madness .....	<b>310</b>
Montessori Matters .....	<b>319</b>
Montessori Matters: A History Manual.....	<b>319</b>
Montessori Matters: A Language Manual.....	<b>319</b>
Montessori Matters: A Mathematics Manual.....	<b>319</b>
Montessori Mozarts.....	<b>324</b>
Montessori Music: Sensorial Exploration W/The Bells ....	<b>74, 324</b>
Montessori Parenting.....	<b>311</b>
Montessori Play And Learn.....	<b>313</b>
Montessori Read & Write .....	<b>316</b>
Montessori School: A Typical Day.....	<b>313</b>
Montessori: The Science Behind The Genius.....	<b>308</b>
Montessori Today.....	<b>315</b>
Montessori Workshop .....	<b>317</b>
• Movable Alphabets .....	<b>96, 97, 98, 99, 100</b>
Mozaiko.....	<b>416</b>
• Multibase Material .....	<b>183</b>
• Multibase Material Spareparts.....	<b>519</b>
• Multiple Shape Puzzle Set .....	<b>21</b>
• Multiples Of Numbers Tables .....	<b>164</b>
• Multiples Tables.....	<b>164</b>
• Multiplication Bead Bar Layout Box .....	<b>161</b>
• Multiplication Board .....	<b>162</b>
Multiplication Board Activity Set .....	<b>162, 252</b>
• Multiplication Board Spareparts.....	<b>512</b>
• Multiplication Equation And Products Box.....	<b>164</b>
Multiplication Snake Game .....	<b>163</b>
• Multiplication Tables .....	<b>162</b>
Multiplication Tables Booklets.....	<b>164</b>
• Multiplication Working Charts .....	<b>163</b>
• Multiplication Working Charts Spareparts.....	<b>512</b>
Music.....	<b>354 - 361</b>
Music And Movement Instructional DVD For Teachers .....	<b>324</b>
Music Instruments Set.....	<b>356</b>
Music Material Cabinet .....	<b>356</b>
Music Set In Plastic Box.....	<b>357</b>
• Music Signs And Notes .....	<b>76</b>
• Music Strip Boards.....	<b>76</b>
Musical Instruments .....	<b>354 - 361</b>
• Mystery Bags .....	<b>55</b>

## N

Nail Board.....	<b>366</b>
Name Cards: First Set Of Botany Cards.....	<b>207</b>
Name Cards: Second Set Of Botany Cards.....	<b>208</b>
Name Cards: Third Set Of Botany Cards.....	<b>209</b>
Natural Wood Pencil Holder.....	<b>84, 254, 346</b>
NLD: Primary Materials.....	<b>318</b>
North America.....	<b>225</b>
North America Control Maps.....	<b>225</b>
North America: Labels.....	<b>225</b>
North America: Paper Maps.....	<b>225</b>
Noun Labels For The Farm.....	<b>88</b>
Number Puzzle 1-10.....	<b>443</b>
• Number Rods.....	<b>120</b>
Number Rods Activity Set.....	<b>120, 253</b>
• Number Rods Spareparts.....	<b>497</b>
• Number Tiles.....	<b>173, 187</b>
• Number Tiles Spareparts.....	<b>517</b>
Numbers Puzzle.....	<b>444</b>
Numerals And Counters.....	<b>126</b>
• Numerals And Signs: Cursive.....	<b>125</b>
• Numerals And Signs: Print.....	<b>125</b>
• Numerals And Signs: USA Style Print.....	<b>125</b>
Numerix.....	<b>435</b>
Nurturing The Spirit.....	<b>314</b>
Nurturing The Spirit: Spanish Edition.....	<b>314</b>

## O

• Object Permanence Box With Drawer.....	<b>14</b>
• Object Permanence Box With Tray.....	<b>14</b>
Ocean Drum.....	<b>357</b>
Okidee.....	<b>400, 401</b>
• One Golden Bead Cube Of 1000.....	<b>132</b>
• One Golden Bead Square Of 100.....	<b>132</b>
• One Yellow Cube: (27 x 27 x 27 cm).....	<b>177</b>
Our Peaceful Classroom.....	<b>313</b>
Outdoor Broom.....	<b>35</b>
• Outdoor Play.....	<b>462, 463</b>

## P

Paint - Finger Paint.....	<b>332</b>
Paint - Poster Paint.....	<b>333</b>
Paint - Repair Paint.....	<b>266</b>
Paint Brush - Toddler.....	<b>335</b>
Paint Brushes - Flat Bristles.....	<b>334</b>
Paint Brushes - Round Bristles.....	<b>334</b>
Paint Brushes - Spatter/Dabbing.....	<b>335</b>

Paint Brushes - Tapered Bristles.....	<b>334</b>
Paint Cup Trays.....	<b>335</b>
Paint Cups - Round With Lid.....	<b>336</b>
Paint Cups - Non-Spill.....	<b>335</b>
Paint Drying Racks.....	<b>338</b>
Paint Palette.....	<b>336</b>
Paint Palette Tray: Two-Piece.....	<b>337</b>
Paint Paper.....	<b>337</b>
Paint Pots.....	<b>336</b>
Panoramix: Geometric Shapes.....	<b>398</b>
Panoramix: House - Tree - Animal.....	<b>398</b>
Paper - Craft.....	<b>347</b>
Paper - Crepe.....	<b>348</b>
Paper - Inset.....	<b>84, 263</b>
Paper - Painting.....	<b>337, 338</b>
Paper - Sewing/Embroidery.....	<b>348</b>
Paper - Weaving.....	<b>349</b>
Paper - Writing.....	<b>116, 117, 262, 263</b>
• Paper Box: 14 x 14 cm.....	<b>84</b>
• Paper For Recovering Squares And Cubes: (100).....	<b>133</b>
• Paper Grammar Symbols In Box.....	<b>104</b>
• Paper Grammar Symbols Replacement Set.....	<b>104</b>
Paper Maps.....	<b>220 - 231</b>
Paper Maps Cabinet.....	<b>235, 298</b>
Papilo.....	<b>389</b>
Papilo: Coloring Pad (50).....	<b>389</b>
Parcours.....	<b>397</b>
Parenting As A Help To Life.....	<b>312</b>
Parts Of The Flag Descriptions.....	<b>243</b>
Parts Of The Flag Nomenclature Cards.....	<b>243</b>
Paste Or Glue Brush.....	<b>255</b>
Patero.....	<b>417</b>
• Patterns For Square Root.....	<b>179</b>
Peace 101.....	<b>317</b>
• Pegs For The Algebraic Peg Board.....	<b>178</b>
Pencil/Glue Brush Storage Block: 6 Holes.....	<b>254</b>
Pencil/Glue Brush Storage Block: 12 Holes.....	<b>254</b>
Pencil Holders.....	<b>84, 254, 346</b>
Pencil Holders Spareparts.....	<b>493</b>
Pencil Sharpener: 3-Sided Pencils - Small.....	<b>85, 261, 346</b>
Pencil Sharpener: All Pencil Types - Electric.....	<b>85, 261, 346</b>
Pencil Sharpener: All Pencil Types - Table Model.....	<b>85, 261, 346</b>
Pencils.....	<b>84, 85, 259, 260, 261, 343, 344, 345</b>
Perlino.....	<b>423</b>
Phonetic Flash Cards.....	<b>94</b>
Phonetic Pictures And Labels.....	<b>94</b>
Phonetic Reading Cards.....	<b>94</b>
Phonogram Booklets.....	<b>93</b>
Phonogram Cards.....	<b>93</b>
Photo Puzzles: Farm Animals - Set Of 4.....	<b>451</b>
Photo Puzzles: Wild Animals - Set Of 4.....	<b>451</b>
Photos.....	<b>268, 269</b>

Pin Flag Stand .....	<b>236, 367</b>
• Pin Map Flags .....	<b>237, 238, 239, 240</b>
• Pin Maps .....	<b>236, 237</b>
• Pin Maps Spareparts .....	<b>533</b>
• Pink Tower .....	<b>50</b>
• Pink Tower Spareparts .....	<b>475</b>
Pipe Drum - Musical Instrument .....	<b>360</b>
Plakplak: Powder Glue .....	<b>353</b>
Planets Of The Solar System .....	<b>367</b>
Plan .....	<b>410</b>
Plan Plus .....	<b>410</b>
Plantsongs - From The Ground Up .....	<b>324</b>
• Plastic Grammar Symbols In Box .....	<b>104</b>
Plastic Craft Mats .....	<b>350</b>
Plastic Cutting Mats .....	<b>351</b>
• Plastic Number Cards .....	<b>134</b>
Plastic Sleeve For Nomenclature Cards: (10) .....	<b>256</b>
Plus .....	<b>419</b>
Positive, Comparative, Superlative .....	<b>87</b>
Poster Paint .....	<b>333</b>
Post-It Drawing Paper .....	<b>338</b>
• Power Of Two Cube .....	<b>177</b>
• Power Of Two Cube Spareparts .....	<b>513</b>
• Power Of Three Cube .....	<b>177</b>
• Power Of Three Cube Spareparts .....	<b>513</b>
Practical Life .....	<b>32 - 47</b>
• Practical Life Spareparts .....	<b>474</b>
• Pressure Cylinders .....	<b>60</b>
• Printed Alphabet: Cursive, Blue .....	<b>101</b>
• Printed Alphabet: Cursive, Red .....	<b>101</b>
• Printed Alphabet: Print, Blue .....	<b>101</b>
• Printed Alphabet: Print, Red .....	<b>101</b>
• Printed Alphabet Box: Cursive .....	<b>101</b>
• Printed Alphabet Box: Print .....	<b>101</b>
• Printed Arrows: 100/1000 Bead Chains .....	<b>148</b>
• Printed Arrows: Short Bead Chains .....	<b>150</b>
• Printed Arrows: The Bead Material .....	<b>151</b>
• Printed Grammar Cards .....	<b>114</b>
• Printed Numerals Box .....	<b>121</b>
• Printed Numerals: Cursive .....	<b>121</b>
• Printed Numerals: Print .....	<b>121</b>
• Printed Numerals: USA Style Print .....	<b>121</b>
• Prisms For Brown Stair .....	<b>51, 199</b>
Problem Slips: Addition Working Charts .....	<b>156</b>
Problem Slips: Division Working Charts .....	<b>166</b>
Problem Slips: Multiplication Working Charts .....	<b>163</b>
Problem Slips: Subtraction Working Charts .....	<b>160</b>
• Psychogeometry: Hard Cover .....	<b>309</b>
• Psychogeometry: Soft Cover .....	<b>309</b>
Punch-Out Pad .....	<b>256</b>
Punch-Out Pin .....	<b>256</b>
Punch-Out Pin Storage Block: 12 Holes .....	<b>256</b>

• Puzzle Map: Africa .....	<b>227</b>
• Puzzle Map: Asia .....	<b>224</b>
• Puzzle Map: Australia .....	<b>222</b>
• Puzzle Map: Austria .....	<b>234</b>
• Puzzle Map: Canada .....	<b>230</b>
• Puzzle Map: China .....	<b>234</b>
• Puzzle Map: Europe .....	<b>223</b>
• Puzzle Map: France .....	<b>233</b>
• Puzzle Map: Germany .....	<b>233</b>
• Puzzle Map: Ireland .....	<b>232</b>
• Puzzle Map: Japan .....	<b>234</b>
• Puzzle Map: Mexico .....	<b>231</b>
• Puzzle Map: North America .....	<b>225</b>
• Puzzle Map: South America .....	<b>226</b>
• Puzzle Map: Sweden .....	<b>232</b>
• Puzzle Map: Switzerland .....	<b>232</b>
• Puzzle Map: Taiwan .....	<b>234</b>
• Puzzle Map: The Netherlands .....	<b>233</b>
• Puzzle Map: The United Kingdom .....	<b>232</b>
• Puzzle Map: The United States .....	<b>228</b>
• Puzzle Map: World Parts .....	<b>220</b>
• Puzzle Map: World Parts - Asia View .....	<b>220</b>
• Puzzle Map Cabinet .....	<b>235, 298</b>
• Puzzle Map Stand .....	<b>235, 298</b>
• Puzzle Maps Spareparts .....	<b>522 - 532</b>
Puzzle Words .....	<b>94</b>
Pyramid .....	<b>414</b>
Pythagoras Board .....	<b>147</b>
Pythagoras Board Activity Set .....	<b>147, 253</b>
Pythagoras Board: Control Chart .....	<b>147</b>
Pythagoras Board Copy Masters .....	<b>147, 253</b>
Pythagoras Board Spareparts .....	<b>501</b>

## Q

Quantity Splitting Box .....	<b>436</b>
Quanty .....	<b>438</b>

## R

Rainmakers - Musical Instruments .....	<b>358</b>
• Reading Analysis: First Chart And Box .....	<b>111</b>
Reading Scheme For English .....	<b>93</b>
Reading Scheme Spareparts .....	<b>495</b>
• Reading/Sentence Analysis Set .....	<b>110</b>
• Reading/Sentence Analysis Spareparts .....	<b>495</b>
Reading/Sentence Analysis Template .....	<b>110</b>
Recorder - Musical Instrument .....	<b>359</b>
• Red Beads: (100) .....	<b>171</b>
• Red Rods .....	<b>54</b>



• Red Rods Spareparts .....	<b>482</b>
Reference & DVD's .....	<b>259, 260</b>
Repair Paints .....	<b>266, 267</b>
Researching Montessori Zoology Program .....	<b>326</b>
Resemblance Color Sorting Task: 1 .....	<b>415</b>
Resemblance Color Sorting Task: 3 .....	<b>415</b>
Rhythm Sticks - Musical Instrument .....	<b>361</b>
Ring .....	<b>383</b>
Rings And Sticks Game .....	<b>425</b>
Ritmo .....	<b>396</b>
Rolling Calendar .....	<b>371</b>
Roll Of Paper: The Rolling Calendar .....	<b>371</b>
• Roman Arch .....	<b>365</b>
• Roman Arch Spareparts .....	<b>541</b>
Rope Figures: Thread Design Board .....	<b>382</b>
• Rough And Smooth Boards Set .....	<b>59</b>
• Rough And Smooth Boards Spareparts .....	<b>484</b>
• Rough Gradation Tablets .....	<b>59</b>
Rubando .....	<b>385</b>
Rubber Desk Top Pad: 14 x 14 cm .....	<b>84, 258</b>
Rubber Stamp Set: Alphabet Letters - Outline .....	<b>433</b>
Rubber Stamp Set: Alphabet Letters - Solid .....	<b>433</b>
Rubber Stamps: Clocks .....	<b>378</b>
• Rug Beater .....	<b>352</b>
Rug For Large Numeral Cards .....	<b>146</b>
Rug For Small Numeral Cards .....	<b>146</b>

## S

• Safety Pin Frame .....	<b>39</b>
Sand And Water Scoop .....	<b>463</b>
Sand Bucket And Sieves .....	<b>462</b>
Sand Rake .....	<b>462</b>
Sand Shapes .....	<b>463</b>
Sand Shovels .....	<b>462</b>
• Sandpaper Capitals: Cursive .....	<b>91</b>
• Sandpaper Capitals: Print .....	<b>91</b>
Sandpaper Letter Tracing Tray .....	<b>91</b>
• Sandpaper Letters .....	<b>90, 91, 92</b>
• Sandpaper Letters Box .....	<b>90, 91</b>
• Sandpaper Letters: Cursive .....	<b>90</b>
• Sandpaper Letters: Print .....	<b>90</b>
• Sandpaper Letters: Spanish, Print .....	<b>90</b>
• Sandpaper Numerals Box .....	<b>124</b>
• Sandpaper Numerals: Cursive .....	<b>124</b>
• Sandpaper Numerals: Print .....	<b>124</b>
• Sandpaper Numerals: USA Style Print .....	<b>124</b>
Science Experiences: Part 1 .....	<b>326</b>
Science Experiences: Part 2 .....	<b>326</b>
Science Experiences: Part 3 .....	<b>327</b>
Science Experiences: Part 4 .....	<b>327</b>

Science Experiences: Part 5 .....	<b>327</b>
Science Experiences: Part 6 .....	<b>327</b>
Science Experiences: Part 7 .....	<b>327</b>
Science For Everyday: A Montessori Science Curriculum .....	<b>326</b>
Scissors .....	<b>257, 351</b>
Scissors Storage Block: 12 Holes .....	<b>257</b>
Scissors Exercises .....	<b>257, 387</b>
Scooter .....	<b>467, 471</b>
• Scrubber .....	<b>35</b>
Season Puzzle .....	<b>446</b>
• Second Box Of Color Tablets .....	<b>56</b>
Second Set Of Botany Cards .....	<b>208</b>
Second Set Of Botany Cards Box .....	<b>208</b>
Sensidisc .....	<b>380</b>
Senso .....	<b>379</b>
Senso Junior .....	<b>380</b>
Sensorial .....	<b>48 - 79</b>
Sensorial Cabinet (101 cm) .....	<b>79, 292</b>
• Sentence Analysis Material .....	<b>110, 111</b>
• Sentence Analysis Working Chart .....	<b>111</b>
Seriant I & II .....	<b>413</b>
Serio .....	<b>412</b>
Serpa .....	<b>438</b>
• Set Of Arrows And Circles For Sentence Analysis .....	<b>111</b>
• Set Of Knobless Cylinders .....	<b>53</b>
Sewing/Embroidery Paper - Assorted Colors .....	<b>348</b>
Sharp Scissors: 13 cm .....	<b>257, 351</b>
Sharpeners .....	<b>85, 261, 346</b>
• Sheet With 100 Circles .....	<b>134</b>
• Shoe Buttoning Frame .....	<b>40</b>
• Shoe Lacing Frame .....	<b>40</b>
• Shoe Polishing Brush Set: 4 Brushes .....	<b>36</b>
• Short Bead Chains .....	<b>150</b>
• Short Bead Chains Frame .....	<b>150</b>
Simple Commands: Set 1 .....	<b>87</b>
Simple Commands: Set 2 .....	<b>87</b>
Single Lined Paper: (250) .....	<b>117, 263</b>
• Single Shape Puzzle Set .....	<b>21</b>
Singular And Plural Noun Exercises .....	<b>87</b>
• Skittles .....	<b>171, 190, 499</b>
• Skittle Stand .....	<b>190</b>
Skribi .....	<b>383</b>
Skribi: Supplementary Set .....	<b>383</b>
• Small Bead Frame .....	<b>167</b>
Small Bead Frame Activity Set .....	<b>167, 248</b>
• Small Bead Frame Paper: (50 sheets) .....	<b>167</b>
Small Blackboard Eraser .....	<b>103, 258, 343</b>
• Small Dusting Brush .....	<b>36</b>
• Small Movable Alphabet: Print, Black .....	<b>100</b>
• Small Movable Alphabet: Print, Blue .....	<b>100</b>
• Small Movable Alphabet: Print, Red .....	<b>100</b>
• Small Movable Alphabet Box .....	<b>100</b>

• Small Number Cards, 1-3000 .....	<b>134</b>
• Small Number Cards, 1-9000 .....	<b>134</b>
• Small Number Cards Box .....	<b>134</b>
Small Numerical Cards In Box .....	<b>146</b>
Small Numerical Rods .....	<b>123</b>
Small Numerical Rods Spareparts .....	<b>497</b>
• Small Quatrefoil .....	<b>195</b>
• Small Skittles: (100) .....	<b>171</b>
• Small Square Root Board .....	<b>179</b>
• Small Trapezoid .....	<b>195</b>
• Small Triangle .....	<b>195</b>
Small Wooden Scale .....	<b>371</b>
• Smelling Bottles .....	<b>61</b>
• Smelling Bottles Spareparts .....	<b>485</b>
• Smooth Gradation Board .....	<b>59</b>
• Smooth Gradation Tablets .....	<b>59</b>
• Snapping Frame .....	<b>39</b>
Solaris .....	<b>376</b>
• Sorting Tray .....	<b>30, 42</b>
• Sound Boxes .....	<b>61</b>
• Sound Boxes Spareparts .....	<b>491</b>
South America .....	<b>226</b>
South America Control Maps .....	<b>226</b>
South America: Labels .....	<b>226</b>
South America: Paper Maps .....	<b>226</b>
• Spanish Materials .....	<b>90, 99</b>
• Spanish Medium Movable Alphabet Box .....	<b>99</b>
• Spanish Sandpaper Letters .....	<b>90</b>
Spareparts .....	<b>472 - 541</b>
Spatial Relations .....	<b>395</b>
Spatter Paint Screen .....	<b>337</b>
• Spindle Box: Cursive .....	<b>122</b>
• Spindle Box: Print .....	<b>122</b>
• Spindle Box: USA Style Print .....	<b>122</b>
• Spindles: Set Of 10 .....	<b>123</b>
• Spindles: Loose Spindles Box .....	<b>123</b>
Spirit Whisperers: Teachers Who Nourish A Child's Spirit .....	<b>317</b>
Squared Papers .....	<b>264</b>
• Square Root Materials .....	<b>179</b>
• Squeegee .....	<b>35</b>
• Stamp Game .....	<b>136</b>
Stamp Game Activity Set .....	<b>137, 248</b>
Stamp Game Paper: 15 Problems .....	<b>137</b>
Stamp Game Spareparts .....	<b>499</b>
Stamps - Rubber .....	<b>378, 433</b>
Stand For 3 Carpets .....	<b>78, 297</b>
Stand For 5 Carpets .....	<b>78, 297</b>
Stand For Cylinder Blocks .....	<b>53, 296</b>
Stand For Greenboards .....	<b>103, 295</b>
Stand For Height .....	<b>63, 189</b>
Stand For Paper Boxes .....	<b>348</b>
Stand For Pink Tower .....	<b>50</b>

Stars Exercise .....	<b>367</b>
Stars Exercise Spareparts .....	<b>541</b>
Stickers .....	<b>269</b>
Stool A1: Orange (26 cm) .....	<b>273</b>
Stool B2: Violet (31 cm) .....	<b>273</b>
Stool C3: Yellow (35 cm) .....	<b>273</b>
Stool E5: Green (43 cm) .....	<b>273</b>
Storage Block: For Art & Pasting Materials .....	<b>255</b>
Storage Blocks .....	<b>254 - 257</b>
• Strip Boards .....	<b>155, 159</b>
• Subtraction Equations And Differences Box .....	<b>159</b>
• Subtraction Snake Game .....	<b>158</b>
• Subtraction Snake Game Spareparts .....	<b>506</b>
• Subtraction Strip Board .....	<b>159</b>
• Subtraction Strip Board Spareparts .....	<b>511</b>
• Subtraction Tables .....	<b>160</b>
Subtraction Tables Booklets .....	<b>160</b>
• Subtraction Working Charts .....	<b>159</b>
• Subtraction Working Charts Spareparts .....	<b>511</b>
Symetrix .....	<b>394</b>

## T

Tabaletto .....	<b>423</b>
Table A1: Orange (70 x 50 x 46 cm) .....	<b>274</b>
Table B2: Violet (70 x 50 x 53 cm) .....	<b>274</b>
Table C3: Yellow (70 x 50 x 59 cm) .....	<b>274</b>
• Table Of Pythagoras .....	<b>174</b>
• Table Of Pythagoras Spareparts .....	<b>517</b>
Tactile Box .....	<b>381</b>
Tactile Box: Materials Set 1 .....	<b>381</b>
Tactile Box: Materials Set 2 .....	<b>381</b>
Tangrams .....	<b>428</b>
• Tasting Exercise .....	<b>61</b>
• Tasting Exercise Spareparts .....	<b>485</b>
Teaching Montessori In The Home: The Pre-School Years .....	<b>313</b>
Team Building .....	<b>424</b>
• Teen Bead Box: Connected Beads Nylon .....	<b>141</b>
• Teen Bead Box: Individual Beads Glass .....	<b>141</b>
• Teen Bead Box: Individual Beads Nylon .....	<b>141</b>
• Teen Boards: Cursive .....	<b>140</b>
• Teen Boards: Print .....	<b>140</b>
• Teen Boards: USA Style Print .....	<b>140</b>
Teething Ball .....	<b>31</b>
Tello .....	<b>444</b>
Tellurium .....	<b>368</b>
Tellurium Activity Set .....	<b>253, 368</b>
Template For Grammar Symbols .....	<b>104</b>
Template For Sentence Analysis .....	<b>110</b>
• Tens Bead Box: Connected Beads Nylon .....	<b>143</b>
• Tens Bead Box: Individual Beads Glass .....	<b>143</b>

• Tens Bead Box: Individual Beads Nylon .....	143	The Stars Exercise Spareparts .....	541
• Tens Boards: Cursive.....	142	The Rolling Calendar.....	371
• Tens Boards: Print.....	142	The Secret Of Childhood .....	307
• Tens Boards: USA Style Print.....	142	The Sensorial Cabinet (101 cm).....	79
• The 1946 London Lectures.....	309	The Whole School Montessori Handbook.....	328
The Absorbent Mind .....	304	The Whole School Montessori Handbook: Supplement.....	328
The Advanced Montessori Method: Volume 1 & 2.....	305	The World In The Palm Of Her Hand .....	317
The Animal Continent Box .....	364	The World Of The Child .....	314
The Black Ribbon .....	369	• Theorem Of Pythagoras .....	196
• The Brown Stair: Brown Lacquer .....	51	• Thermic Bottles.....	60
• The Brown Stair: Clear Lacquer .....	51	• Thermic Bottles Spareparts.....	485
• The Brown Stair Spareparts.....	476	• Thermic Tablets.....	60
The California Lectures Of Maria Montessori - 1915.....	304	• Thermic Tablets Spareparts.....	484
• The Centesimal Frame.....	190	• Third Box Of Color Tablets .....	57
The Child And You.....	320	Third Set Of Botany Cards.....	209
The Child In The Family.....	304	Third Set Of Botany Cards Box.....	209
The Child, Society And The World.....	304	Thoughtful Living Series .....	325
The Child's Right To Develop.....	320	Thread Ring .....	28
The Clock Exercise .....	377	• Three Discs On A Vertical Dowel .....	23
• The Complete Practical Life Stand .....	34, 294	Time Line .....	370
The Cosmic Wonder Books .....	325	Tim Tom .....	450
• The Demonstration Tray.....	66	Toddler Paint Brush .....	335
The Discovery Of The Child .....	307	Toddler Scissors: 9 cm .....	257, 351
The Essential Montessori.....	315	Toddler Trikes .....	31, 466, 468
The Exercises Of Practical Life .....	320	To Educate The Human Potential .....	306
• The Farm.....	88	Together With Montessori.....	317
• The Farm Spareparts .....	494	Tone Bar Cabinet.....	77, 299
• The Farm Table .....	88, 295	• Tone Bar Keyboards .....	77
The Formation Of Man.....	306	• Tone Bar Mallet: Hard .....	77
• The Geometric Cabinet .....	66	• Tone Bar Mallet: Soft.....	77
• The Geometric Cabinet Spareparts .....	488, 489	• Tone Bars Set With Two Mallets .....	77
• The Geometric Solids.....	70	Touch Spanish: 1 .....	322
• The Geometric Solids Spareparts.....	490	Touch Spanish: 2 .....	322
The Hidden Hinge.....	316	Touch Spanish: 3 .....	322
The Land Of The Parts Of Speech.....	109	Transparent Glue.....	353
• The Metal Insets .....	82	Transparanto .....	403
• The Metal Inset Stands .....	82	Trays.....	37, 133
• The Metal Insets Spareparts.....	493	Triama: Butterflies Puzzle .....	454
The Montessori Index.....	329	Triama: Flowers Puzzle.....	454
The Montessori Method .....	306	• Triangle Inscribed In Circle .....	195
The Montessori Way .....	310	Tricolino .....	421
The Nail Board.....	366	Tricycles .....	466 -471
The Normalized Child .....	316	• Trinomial Cube .....	73, 180
• The Pink Tower .....	50	• Trinomial Cube Spareparts .....	514
• The Pink Tower Spareparts.....	475	Trizzle.....	447
The Practical Implementation Of Montessori Principles.....	320	Trommels - Drums.....	360
• The Red Rods.....	54	Tuning Fork - Musical Instrument.....	361
• The Red Rods Spareparts .....	482	Turn Over .....	408
The Religious Potential Of The Child.....	315	Two-Piece Paint Palette Tray.....	337
• The Roman Arch.....	365		
• The Roman Arch Spareparts.....	541		
The Stars Exercise.....	367		

<b>U</b>	
Understanding Montessori: A Guide For Parents .....	<b>311</b>
Understanding The Human Being .....	<b>310</b>
• Unit Division Board.....	<b>165</b>
Unit Division Board Activity Set.....	<b>165, 253</b>
• Unit Division Board Spareparts .....	<b>509</b>
United States .....	<b>228, 229</b>
United States Control Maps .....	<b>228</b>
United States: Labels .....	<b>228</b>
United States Location Color Set.....	<b>229</b>
United States: Paper Maps .....	<b>229</b>
Unprinted Cards For The Farm.....	<b>88</b>
• Unprinted Grammar Cards.....	<b>114</b>
<b>V</b>	
• Velcro Frame.....	<b>40</b>
Vetrovorm: Threading Game .....	<b>382</b>
Vidico.....	<b>433</b>
Vinyl Sticker: I Love Montessori.....	<b>269</b>
Vinyl Sticker: Kids Love Montessori.....	<b>269</b>
• Volume Box With 250 Cubes .....	<b>198</b>
• Volume Box With 1000 Cubes .....	<b>198</b>
• Volume Box Spareparts.....	<b>518</b>
<b>W</b>	
Wall Frame For The Metal Insets .....	<b>83, 295</b>
Water Based Pens: Black (10).....	<b>138</b>
Water Based Pens: Red (10).....	<b>138</b>
Weaving Mats: Colored (50).....	<b>350</b>
Weaving Mats: White (50) .....	<b>350</b>
Weaving Strips .....	<b>349</b>
Weaving Strips Display .....	<b>349</b>
Weights .....	<b>372</b>
What Is Montessori Elementary?.....	<b>312</b>
What Is Montessori Preschool? .....	<b>312</b>
What You Should Know About Your Child .....	<b>307</b>
Winther Circleline Tricycles .....	<b>468 - 471</b>
Winther Duo Toddler Tricycle .....	<b>468</b>
• Wooden Beads.....	<b>171</b>
Wooden Boards: Set Of 2.....	<b>103</b>
• Wooden Cube Of 1000: Set Of 10.....	<b>133</b>
• Wooden Grammar Symbols .....	<b>106, 107</b>
Wooden Movable Alphabet: Print.....	<b>97</b>
Wooden Movable Alphabet Box: Print.....	<b>97</b>
• Wooden Number Cards: Large 1-9000.....	<b>135</b>
• Wooden Number Cards: Small 1-9000.....	<b>135</b>
• Wooden Square Of 100: Set Of 10 .....	<b>133</b>
Wooden Toddler Trike .....	<b>31, 466</b>
Wooden Tray Large .....	<b>37</b>
Wooden Tray Small: Set Of 2.....	<b>37</b>
Wooden Tray With 2 Unit Cups.....	<b>133</b>
• Working Board For Geometric Stick Material.....	<b>188</b>
Working Chart Equation Paper .....	<b>156, 160, 163, 166</b>
• Working Charts .....	<b>156, 159, 163, 166</b>
World.....	<b>220, 221</b>
World Control Maps.....	<b>220</b>
World: Paper Maps.....	<b>221</b>
Writing Booklets.....	<b>117, 263</b>
Writing Paper: Blue Lines.....	<b>116, 262</b>
Writing Paper: Green Lines.....	<b>116, 262</b>
Writing Papers.....	<b>116, 117, 262, 263, 264</b>
<b>Y</b>	
• Yellow Prisms In Wooden Box.....	<b>198</b>
• Yellow Triangles For Area.....	<b>189</b>
<b>Z</b>	
• Zipping Frame .....	<b>39</b>



The global standard



# Nienhuis

---

## MONTESSORI

Industriepark 14  
7021 BL Zelhem  
The Netherlands  
T +31 (0) 314 - 62 71 10  
F +31 (0) 314 - 62 71 28  
E [info@nienhuis.nl](mailto:info@nienhuis.nl)  
[www.nienhuis.com](http://www.nienhuis.com)

150 South Whisman Road  
Mountain View, CA 94041-1512  
USA  
T 1-650-964-2735 or 1-800-942-8697  
F 1-650-964-8162  
E [info@nienhuis-usa.com](mailto:info@nienhuis-usa.com)  
[www.nienhuis.com](http://www.nienhuis.com)